

[54] BRUSH BLOCK

[76] Inventor: J. Joseph Kelly, III, 8 Bay Path Dr.,
Boylston, Mass. 01505

[**] Term: 14 Years

[21] Appl. No.: 154,129

[22] Filed: Feb. 9, 1988

[52] U.S. Cl. D4/138; D4/199

[58] Field of Search D4/130, 132, 134-135,
D4/137-138, 199; D32/40, 50-52; 15/146, 147
R, 159 R, 160, 171, 176.1, 176.2, 176.3, 228,
229.1-229.3

[56] References Cited

U.S. PATENT DOCUMENTS

- D. 28,682 5/1898 LaPierre D4/130
- D. 181,211 10/1957 Lindstrom D32/50
- D. 242,830 12/1976 Scoggin, Jr. et al. D4/137
- D. 278,099 3/1985 Evans D4/130 X
- 3,034,165 5/1962 Christian D32/50 X

3,108,306 10/1963 McWilliams 15/171

FOREIGN PATENT DOCUMENTS

- 569723 2/1933 Fed. Rep. of Germany 15/171
- 1094927 5/1955 France 15/145
- 756581 9/1956 United Kingdom 15/159 R

Primary Examiner—Wallace R. Burke

Assistant Examiner—Lavone D. Tabor

[57] CLAIM

The ornamental design for a brush block, as shown and described.

DESCRIPTION

FIG. 1 is a perspective view of a brush block showing my new design;

FIG. 2 is a top plan view thereof;

FIG. 3 is a front elevational view thereof;

FIG. 4 is a rear elevational view thereof;

FIG. 5 is a bottom plan view thereof;

FIG. 6 is an end elevational view, the opposite end being a mirror image thereof.

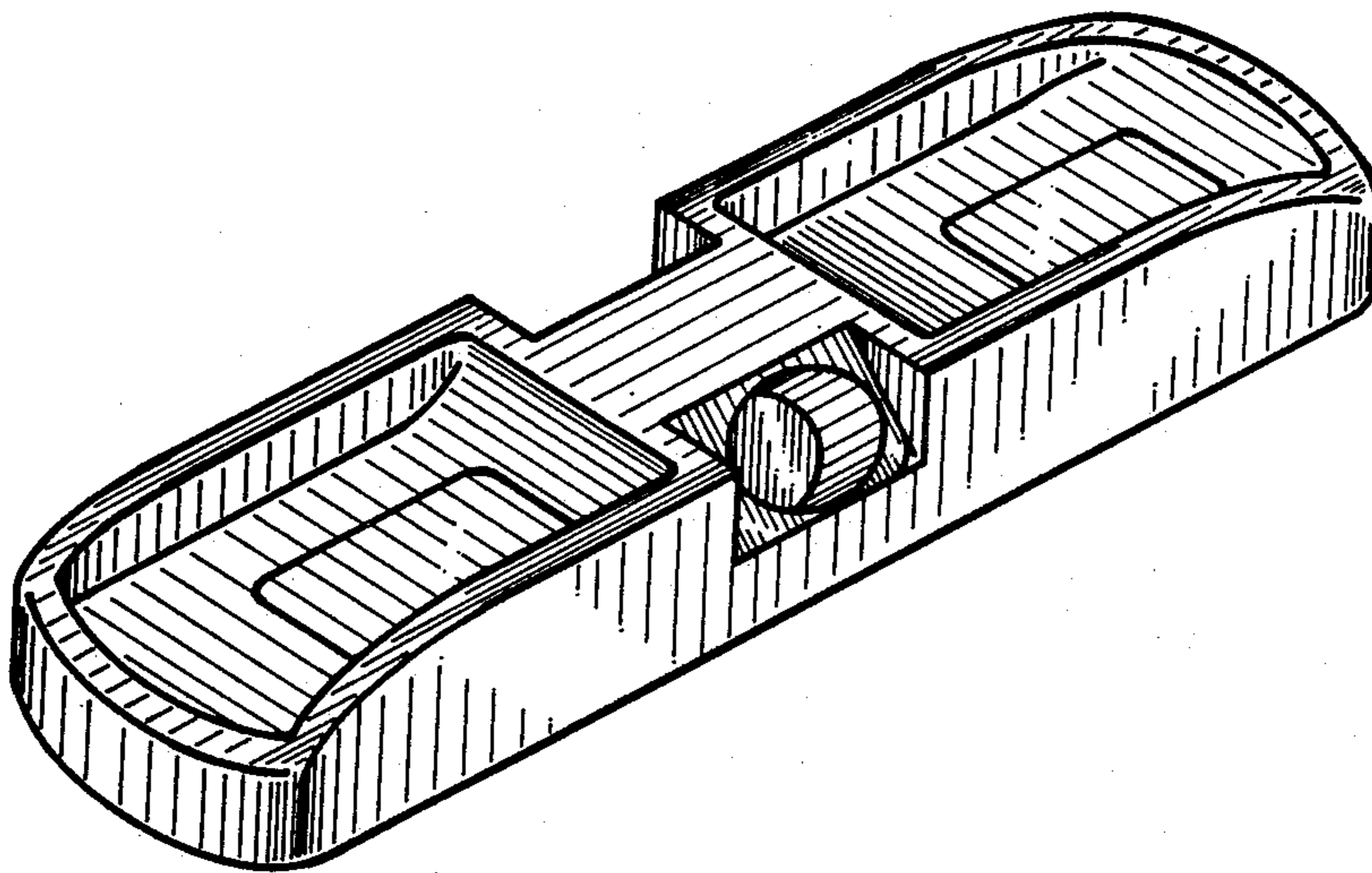

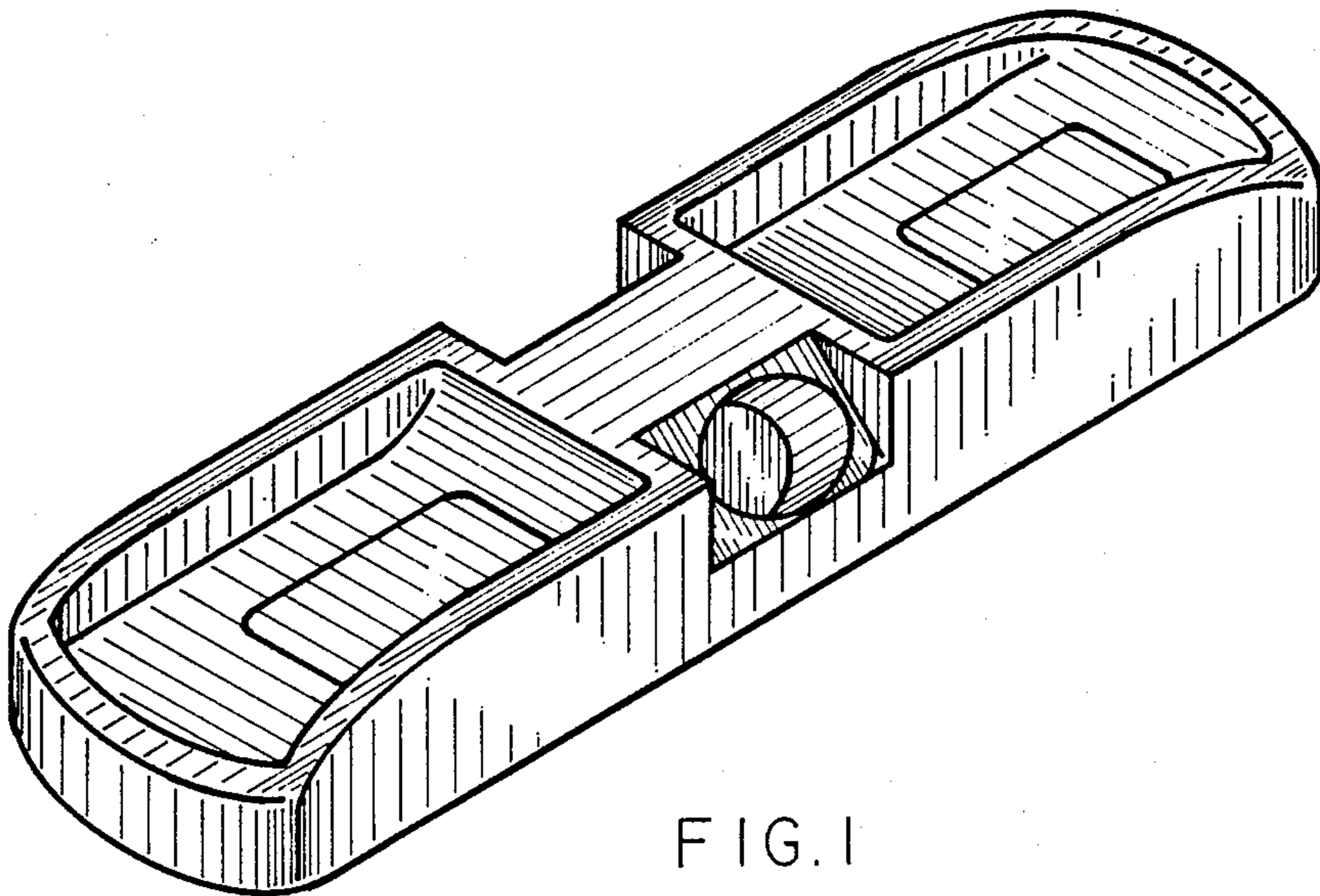

FIG. 1

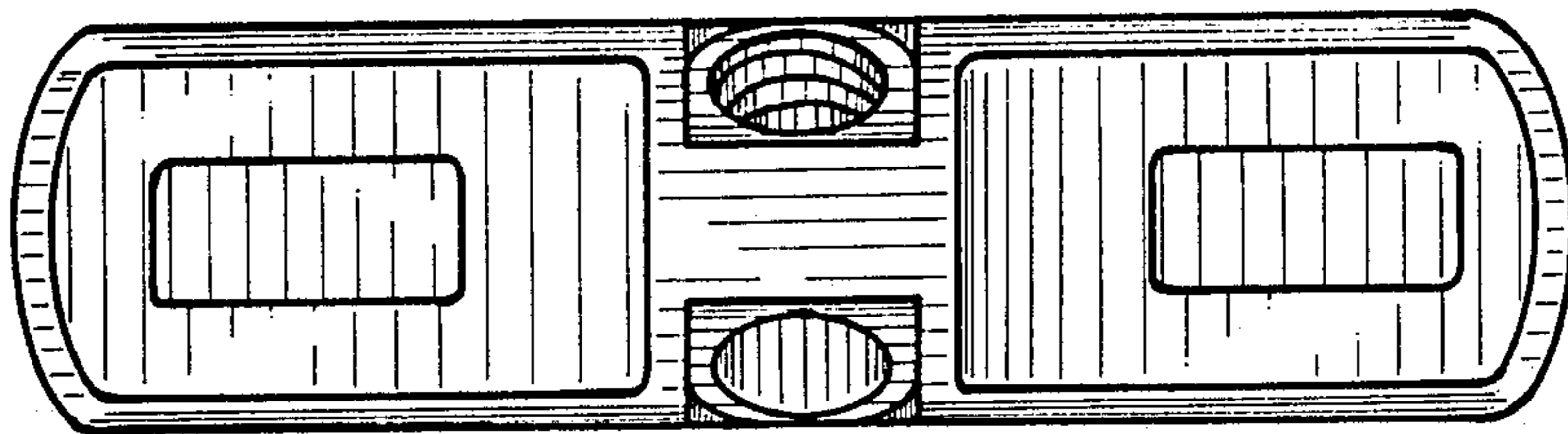

FIG. 2

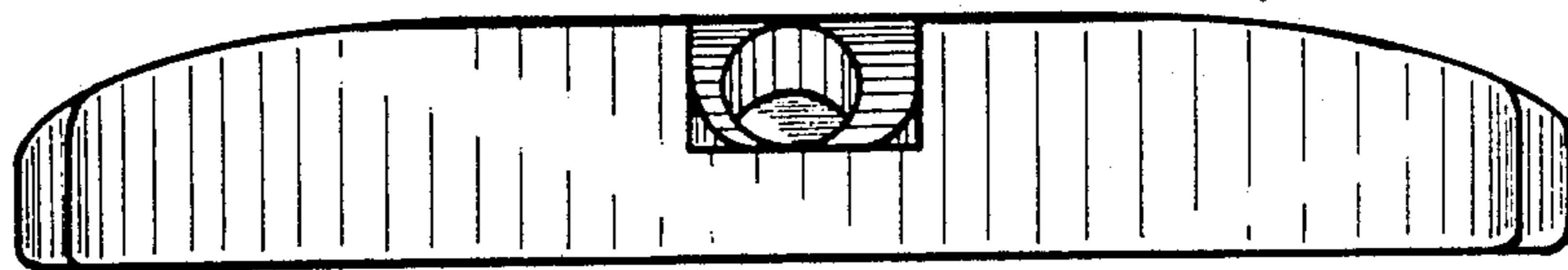

FIG. 3

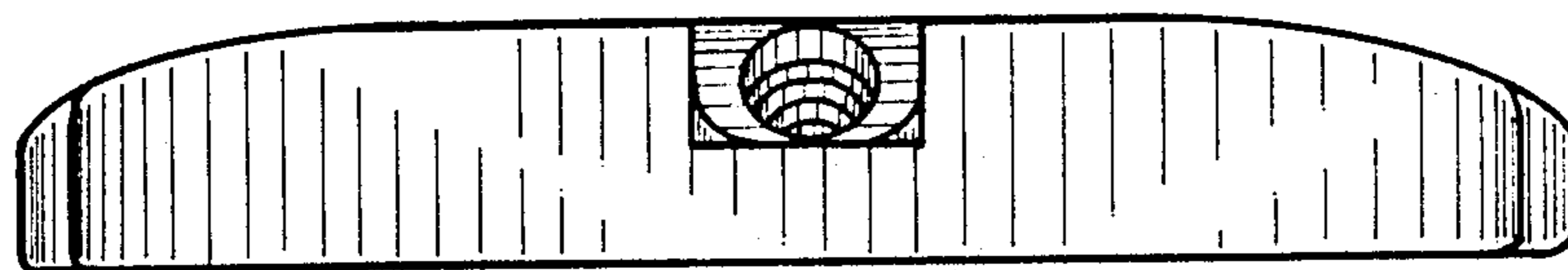

FIG. 4

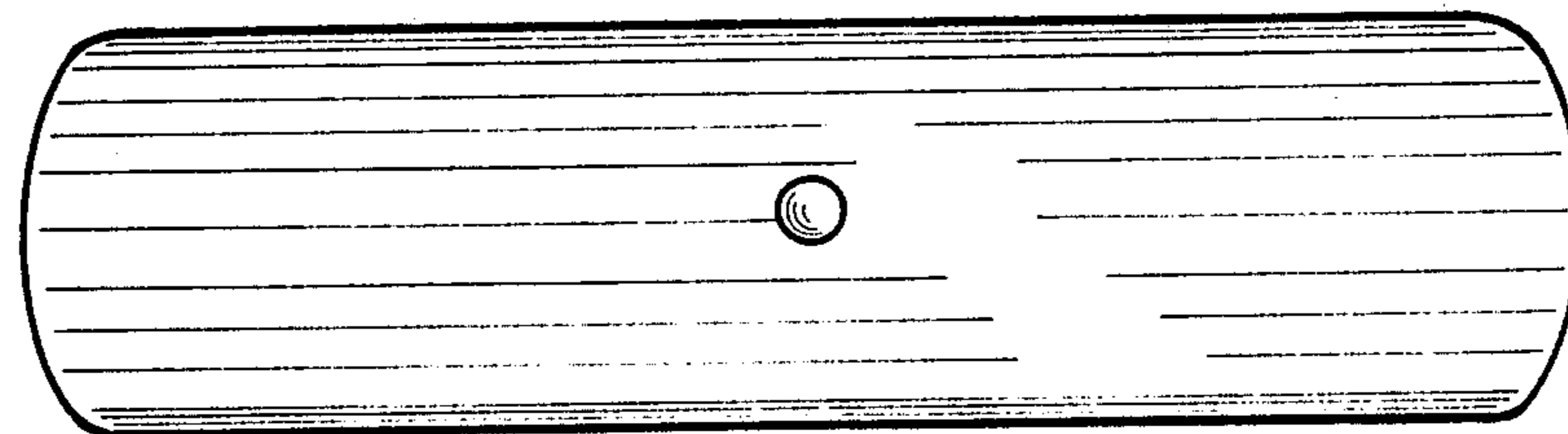

FIG. 5

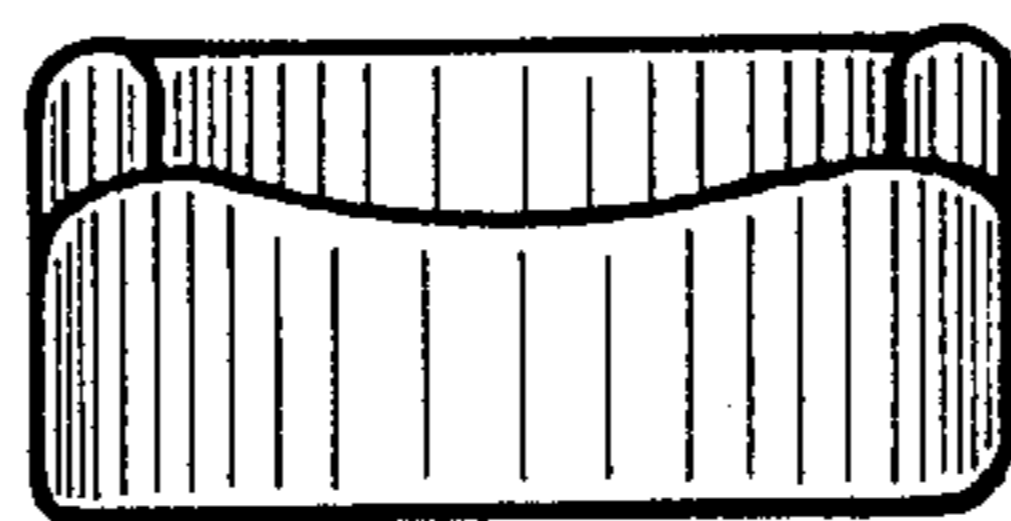

FIG. 6

UNITED STATES PATENT AND TRADEMARK OFFICE
CERTIFICATE OF CORRECTION

PATENT NO. : Des. 306,527
DATED : March 13, 1990
INVENTOR(S) : J. Joseph Kelly, III

It is certified that error appears in the above-identified patent and that said Letters Patent is hereby corrected as shown below:

On the title page:

[76] Inventor: J. Joseph Kelly, III, 6 Ashby, Easton, MD 21601

[73] Assignee: The Kelly Company, Inc., Denton, MD

**Signed and Sealed this
Fourth Day of June, 1991**

Attest:

Attesting Officer

HARRY F. MANBECK, JR.

Commissioner of Patents and Trademarks