

[54] AGRICULTURAL TRACTOR CABIN

[75] Inventors: Genichi Funabashi, Sennan; Hiroyuki Miki, Sakai, both of Japan

[73] Assignee: Kubota, Ltd., Osaka, Japan

[**] Term: 14 Years

[21] Appl. No.: 16,827

[22] Filed: Feb. 20, 1987

[30] Foreign Application Priority Data

Aug. 22, 1986 [JP] Japan 61-32926

[52] U.S. Cl. D15/30

[58] Field of Search D15/10, 15, 23, 30-33; D12/96; 180/89.12, 69.2, 69.22, 69.24-69.25; 296/190; 56/244, 249, 255-257, 264, 13.3-13.4, DIG. 22

[56] References Cited

U.S. PATENT DOCUMENTS

D. 210,658 4/1968 Lazzeroni D15/30

D. 225,521 12/1972 Lorenz et al. D15/23

D. 245,697 9/1977 Skyer et al. D15/30
D. 256,801 9/1980 Skyer et al. D15/23
D. 267,486 1/1983 Martin, Jr. D15/30

Primary Examiner—Nelson C. Holtje
Assistant Examiner—Ruth Takemoto
Attorney, Agent, or Firm—Edwin E. Greigg

[57] CLAIM

The ornamental design for an agricultural tractor cabin, as shown and described.

DESCRIPTION

FIG. 1 is a front elevational view of an agricultural tractor cabin showing our new design; FIG. 2 is a right side elevational view thereof, the left side being a mirror image; FIG. 3 is a rear elevational view thereof; FIG. 4 is a top plan view thereof; FIG. 5 is a bottom plan view thereof; and FIG. 6 is a right side elevational view thereof, the remaining portion of the tractor is shown in broken lines for illustrative purposes only and forms no part of the claimed design.

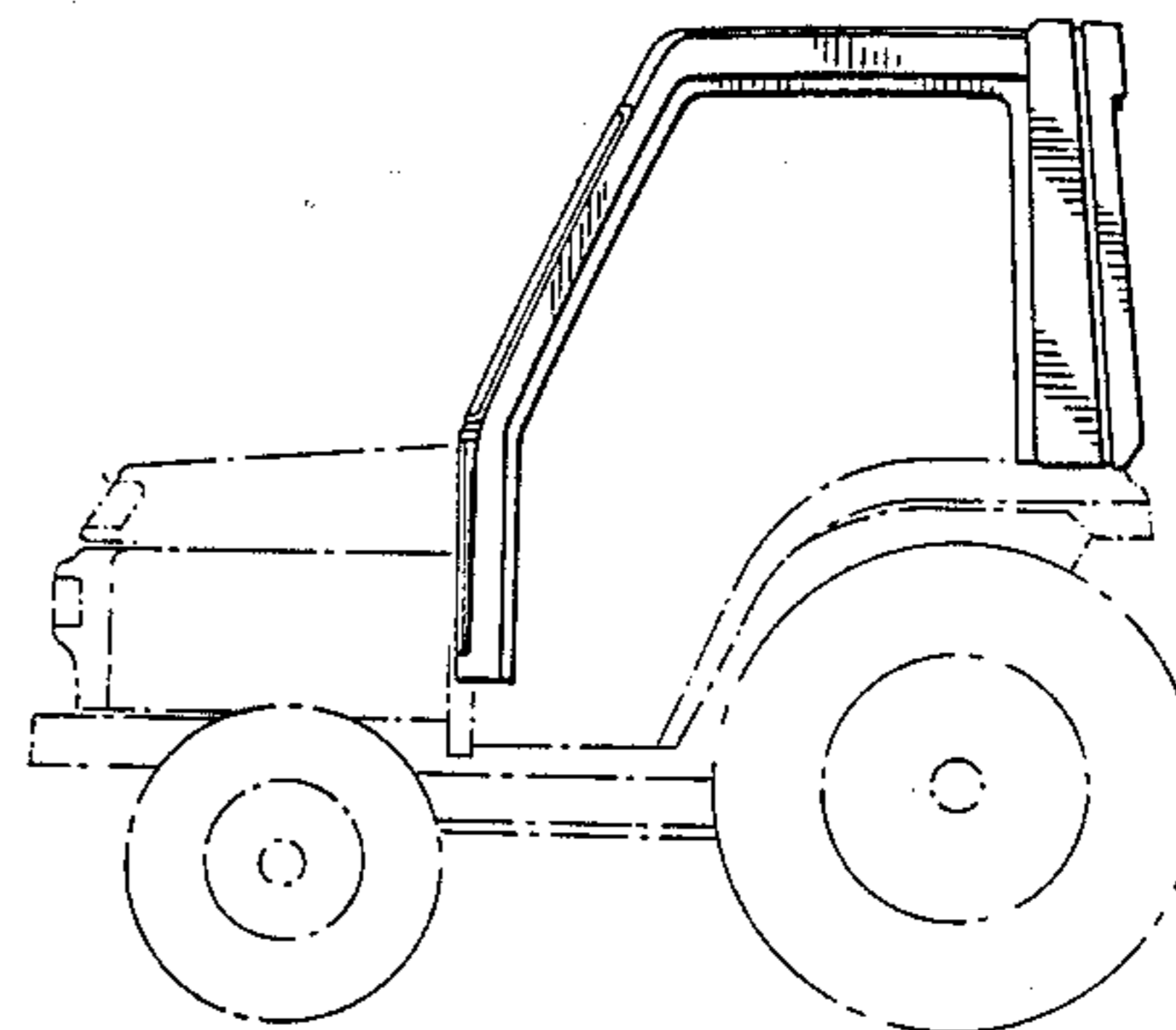
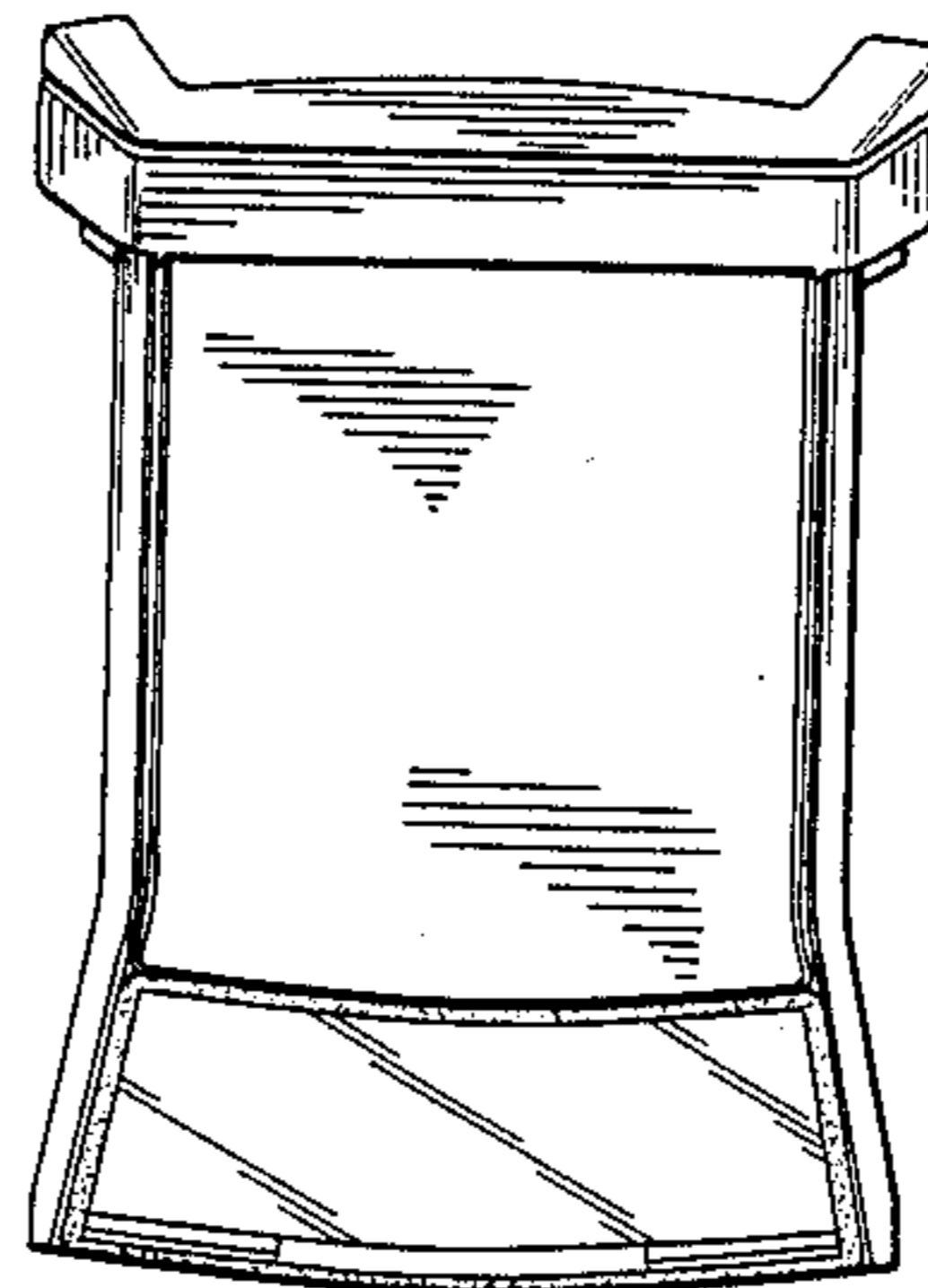
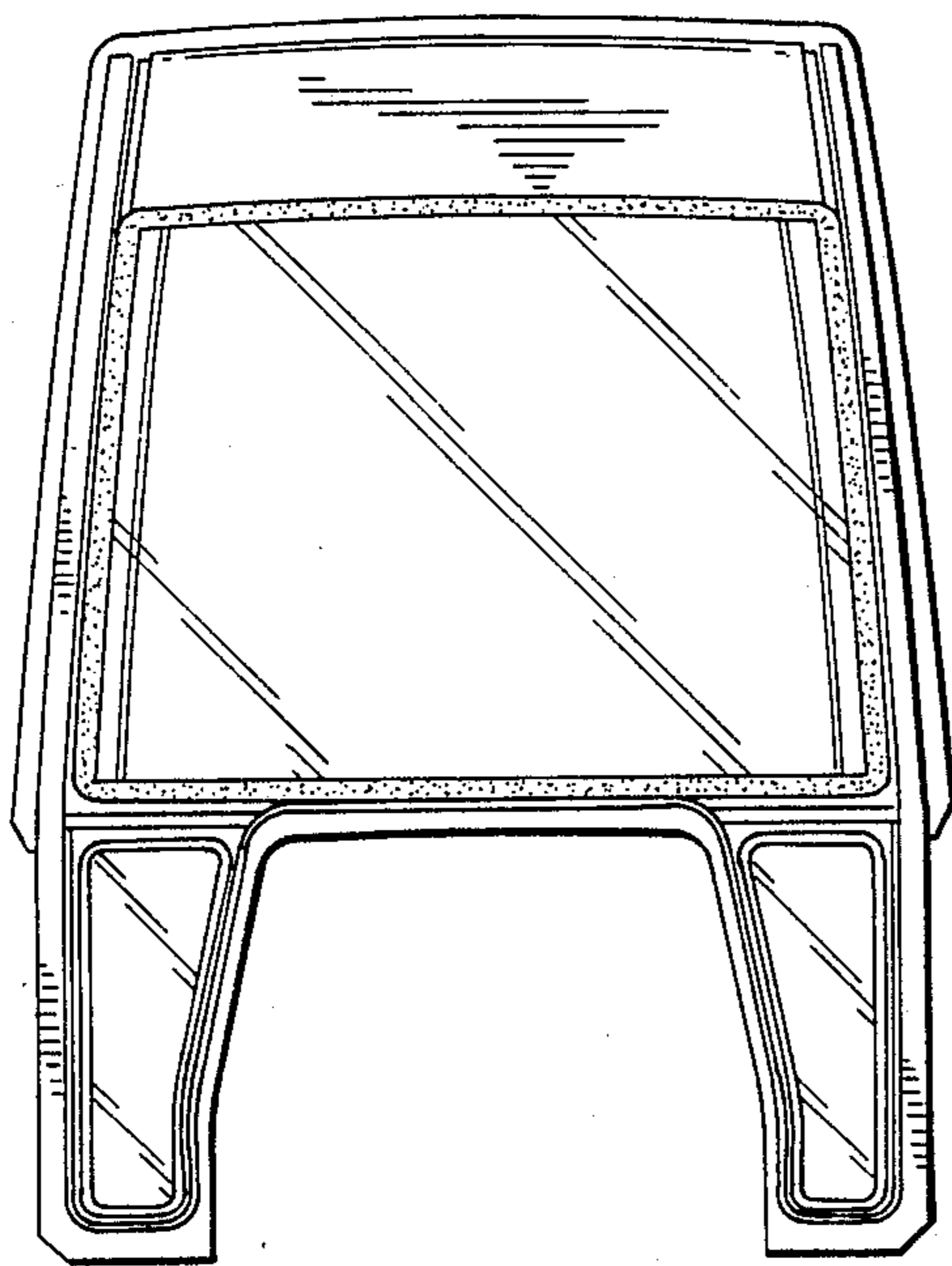

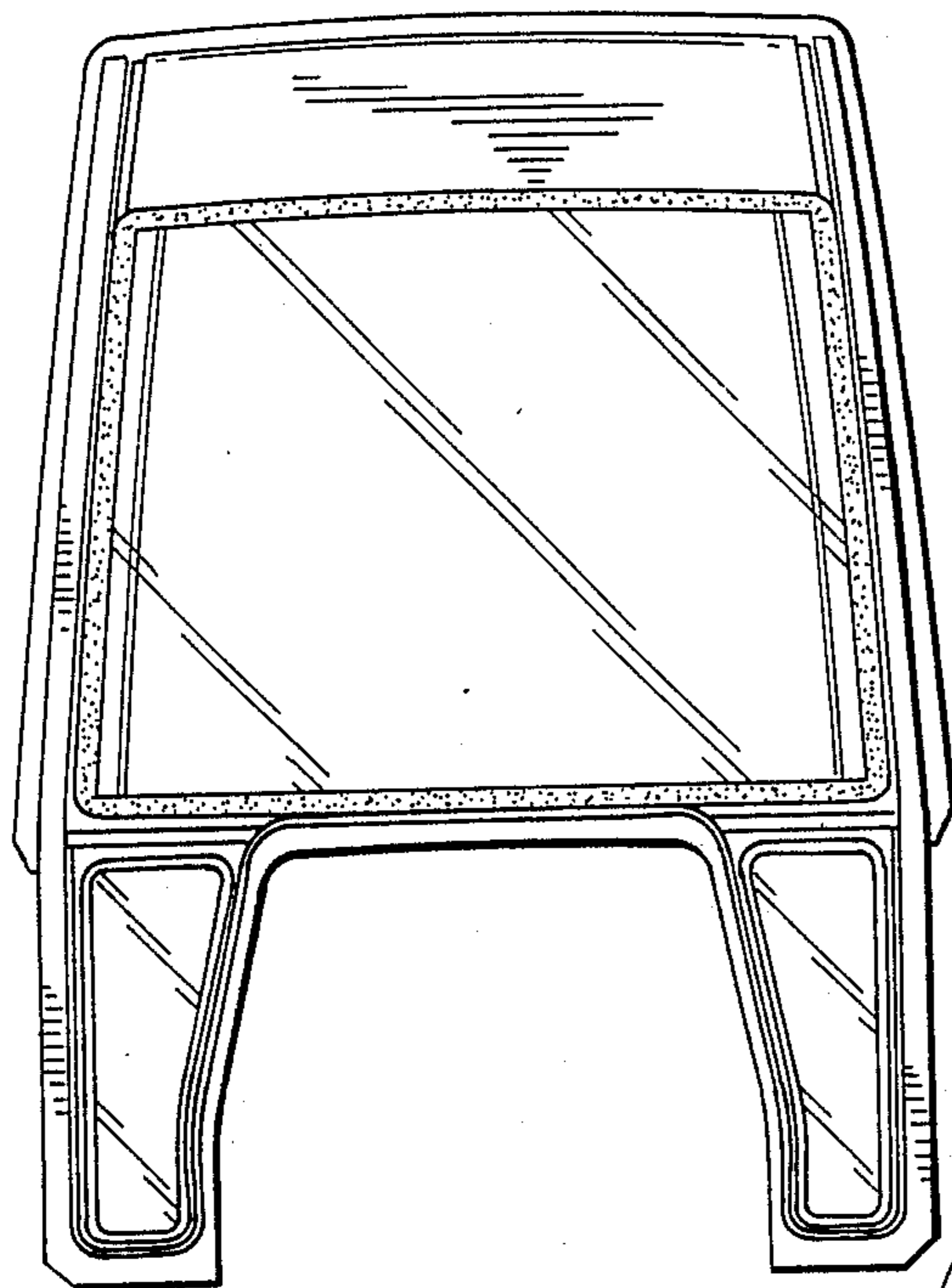

FIG. 1

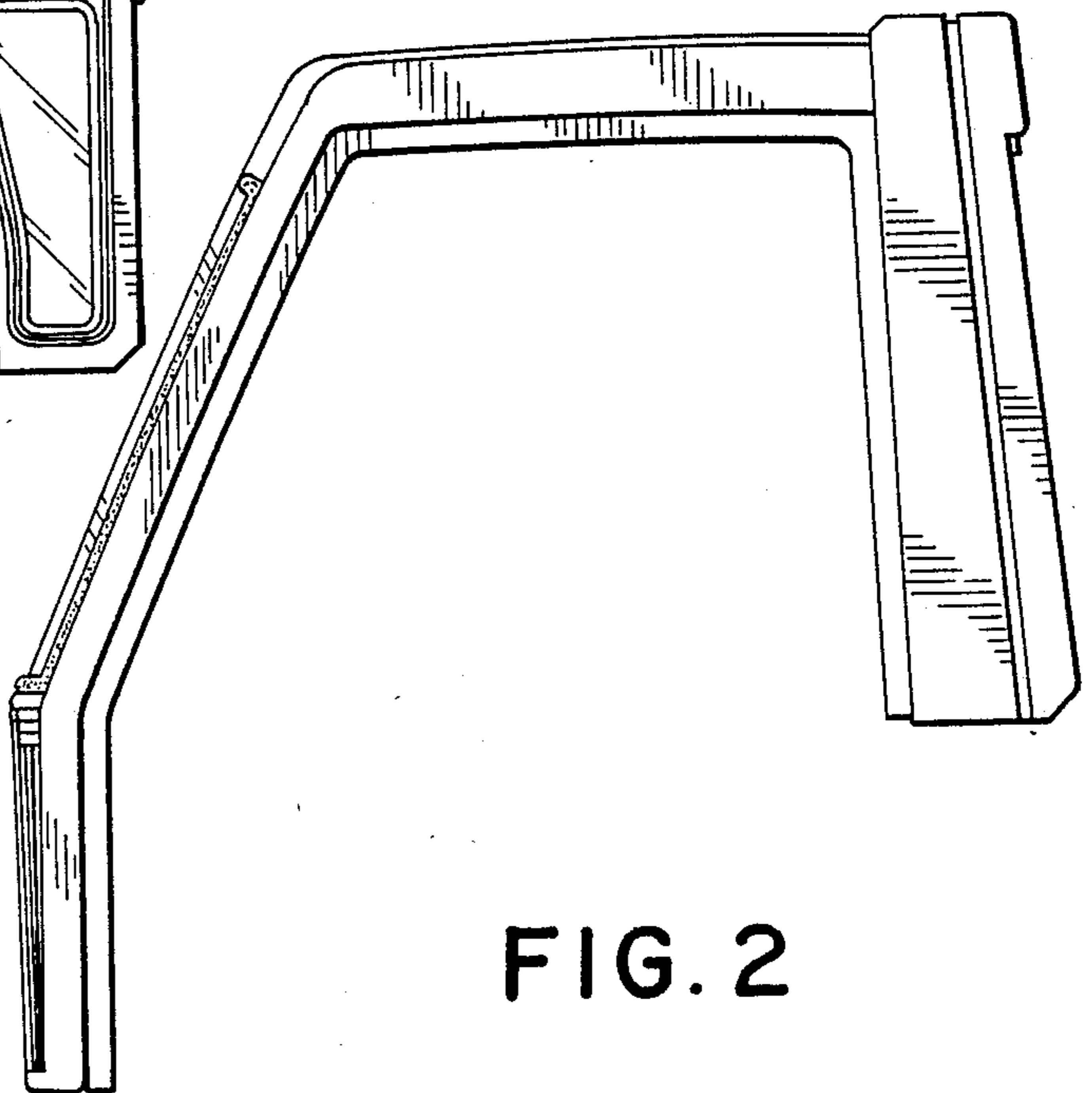

FIG. 2

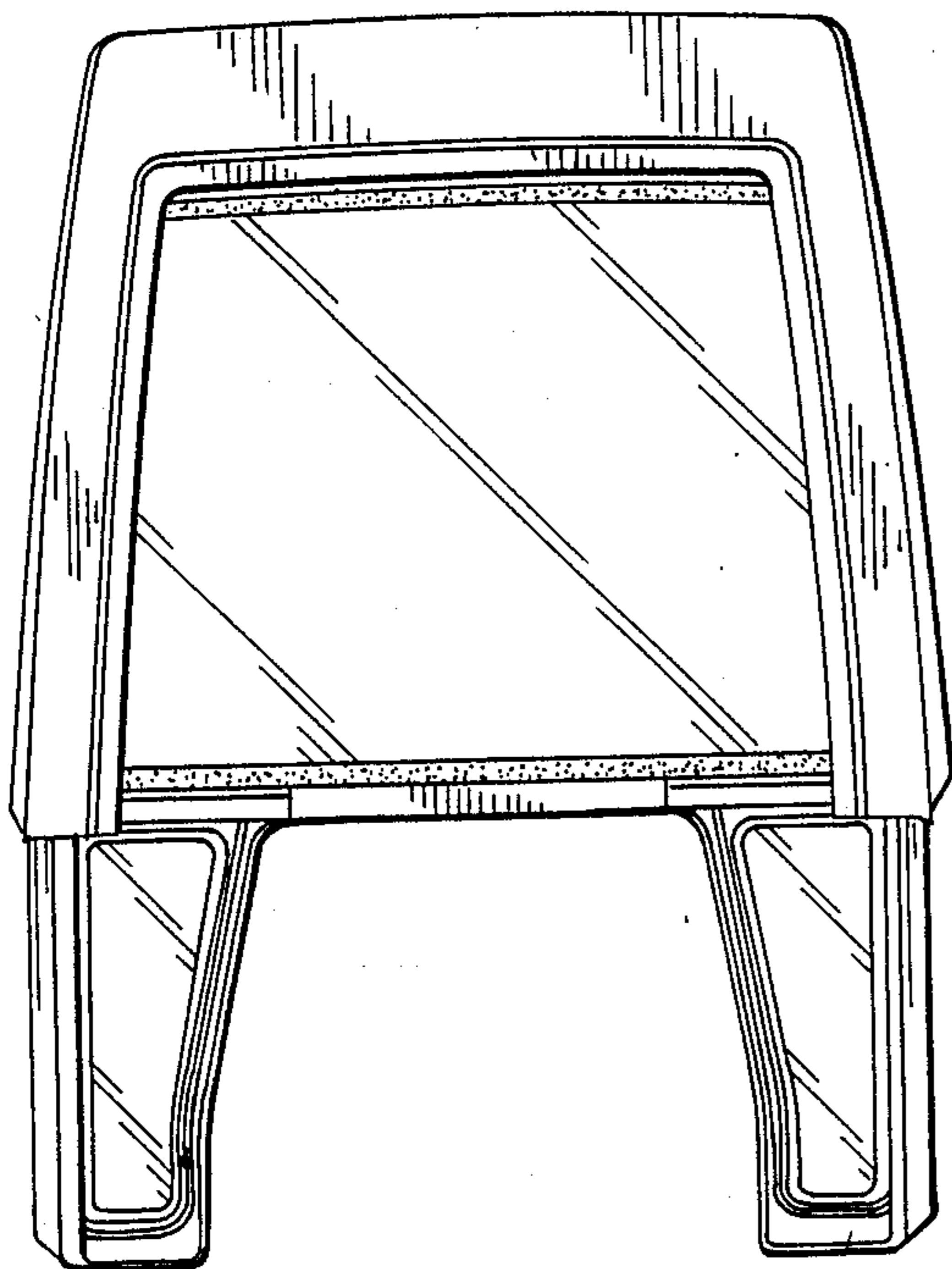

FIG. 3

FIG. 4

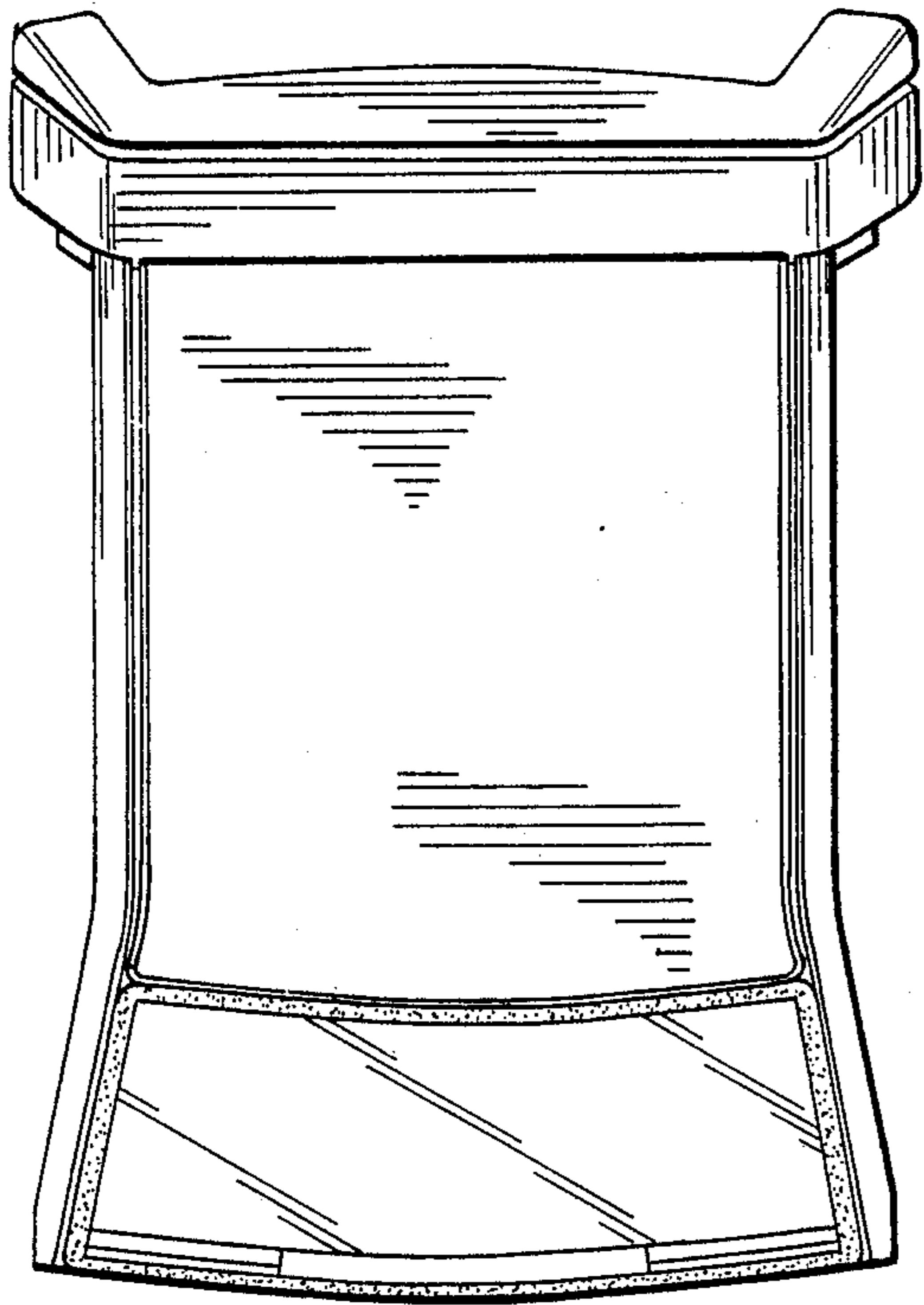

FIG. 5

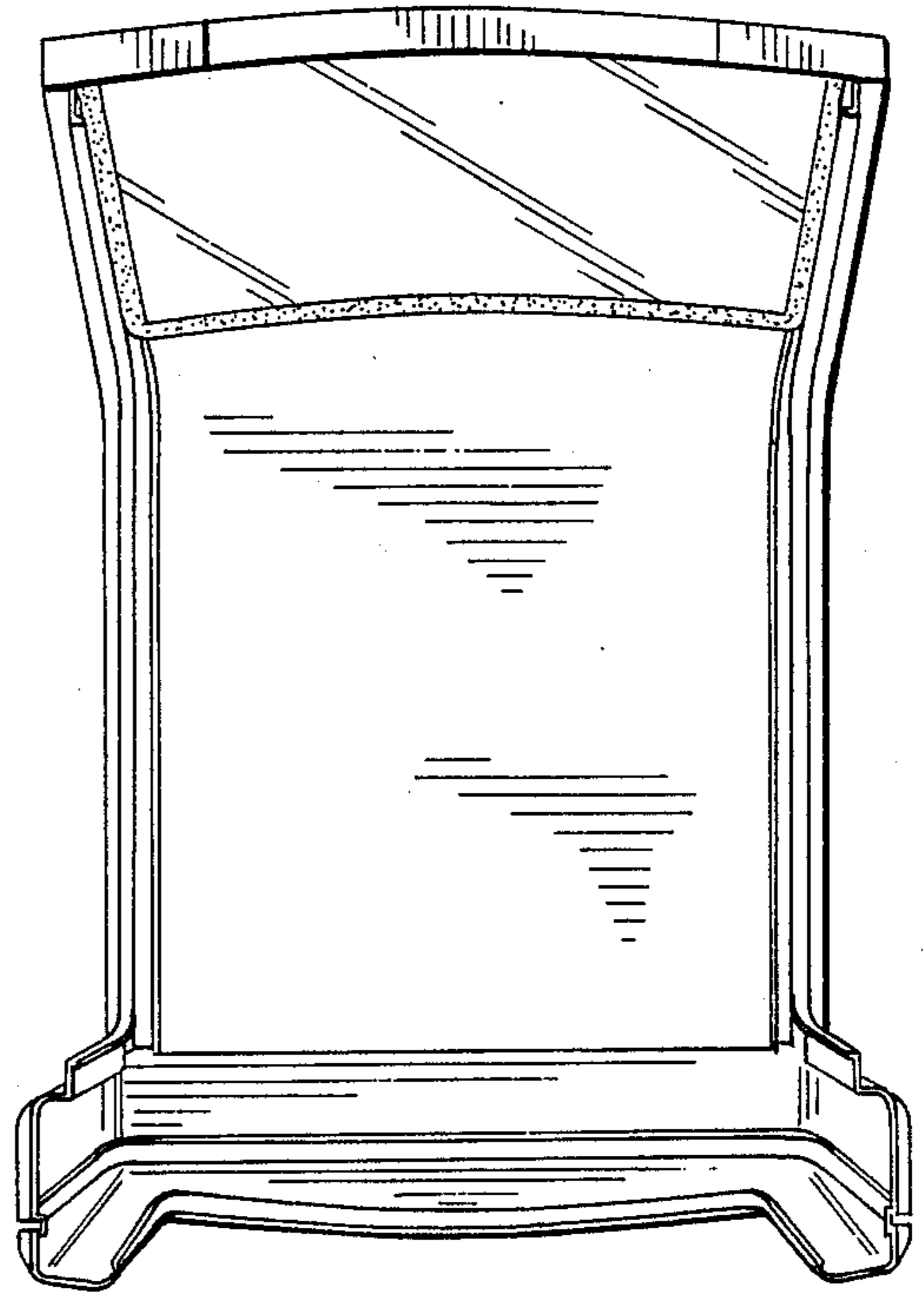

FIG. 6

