

[54] COMBINED TAPE RECORDER AND RADIO

[75] Inventors: Tatsuo Mori; Tsutomu Yamazaki, both of Osaka, Japan

[73] Assignee: Sharp Corporation, Osaka, Japan

[**] Term: 14 Years

[21] Appl. No.: 138,687

[22] Filed: Dec. 28, 1987

[30] Foreign Application Priority Data

Jun. 29, 1987 [JP] Japan 62-26519

[52] U.S. Cl. D14/163

[58] Field of Search D14/154, 160-168, D14/188, 191-198, 299; 455/344, 347, 350, 351

[56] References Cited

U.S. PATENT DOCUMENTS

D. 278,231	5/1985	Tanaka et al.	D14/163
D. 283,613	5/1986	Nakamura et al.	D14/163
D. 295,855	5/1988	Koo	D14/163
D. 297,834	9/1988	Kawabe et al.	D14/163

OTHER PUBLICATIONS

HFD, 1/5/87, p. 109, top left-Yorx AM/FM stereo triple-cassette system, Model FP1010.

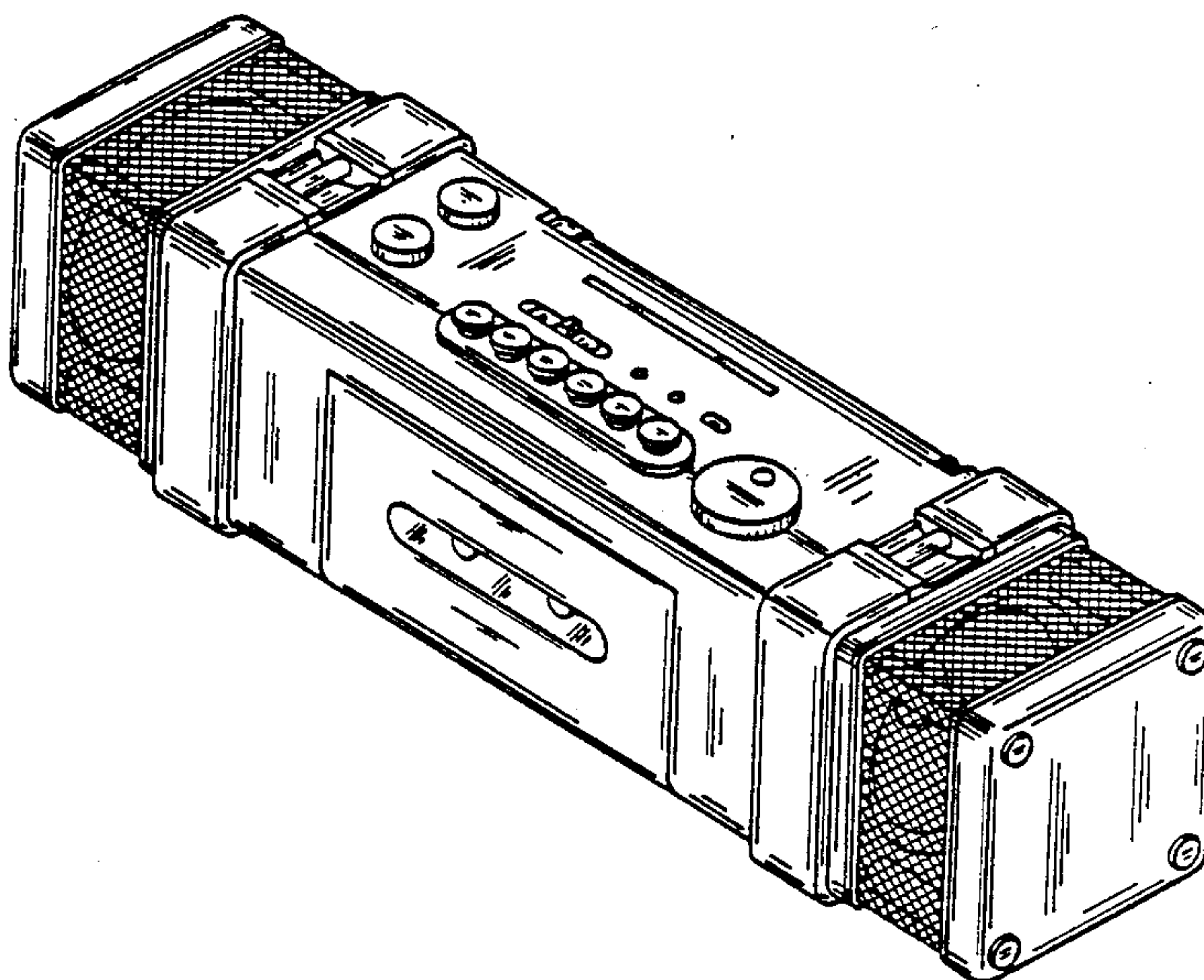
Primary Examiner—Bernard Ansher
Assistant Examiner—Theodore M. Shooman
Attorney, Agent, or Firm—Flehr, Hohbach, Test, Albritton & Herbert

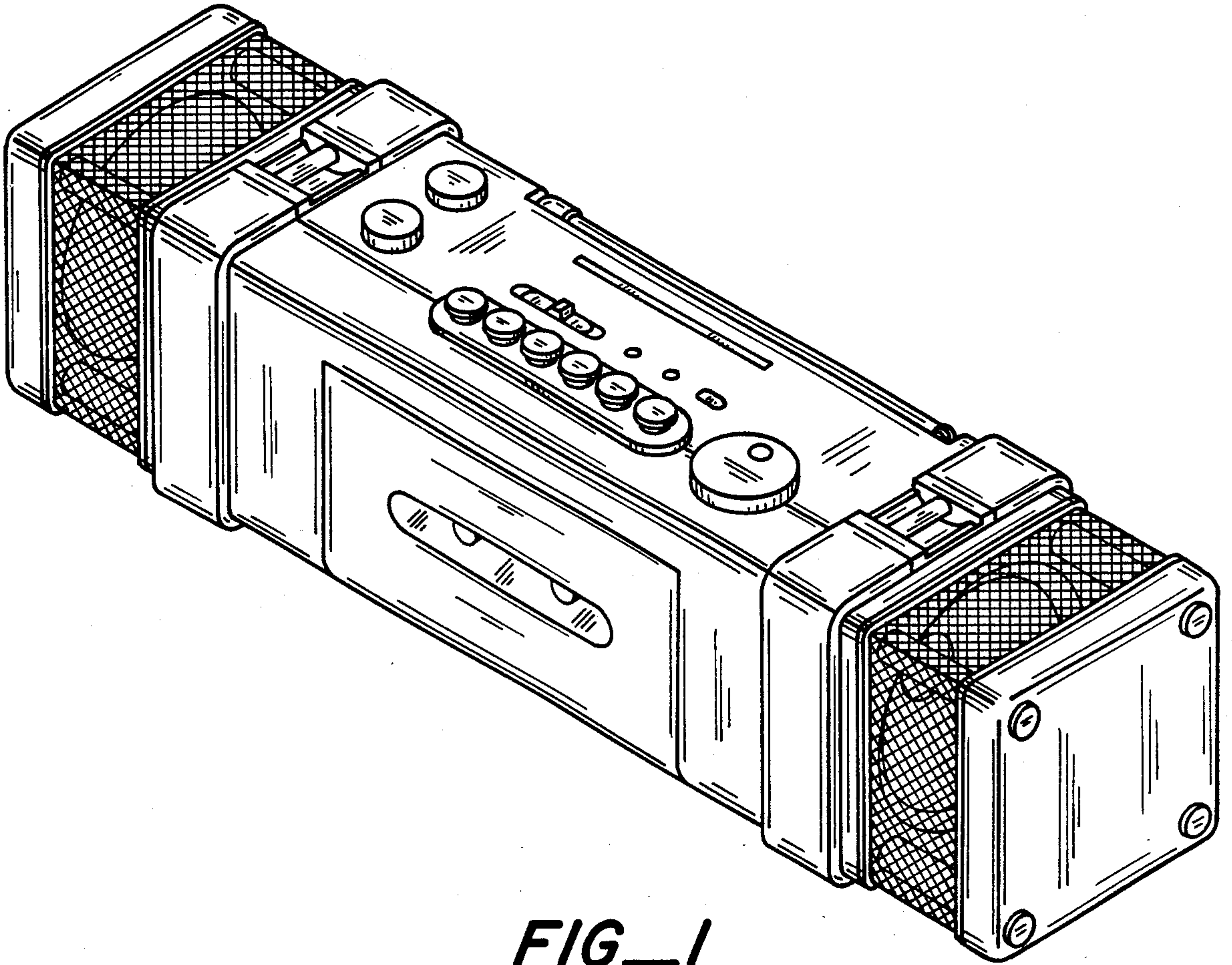
[57] CLAIM

The ornamental design for a combined tape recorder and radio, as shown.

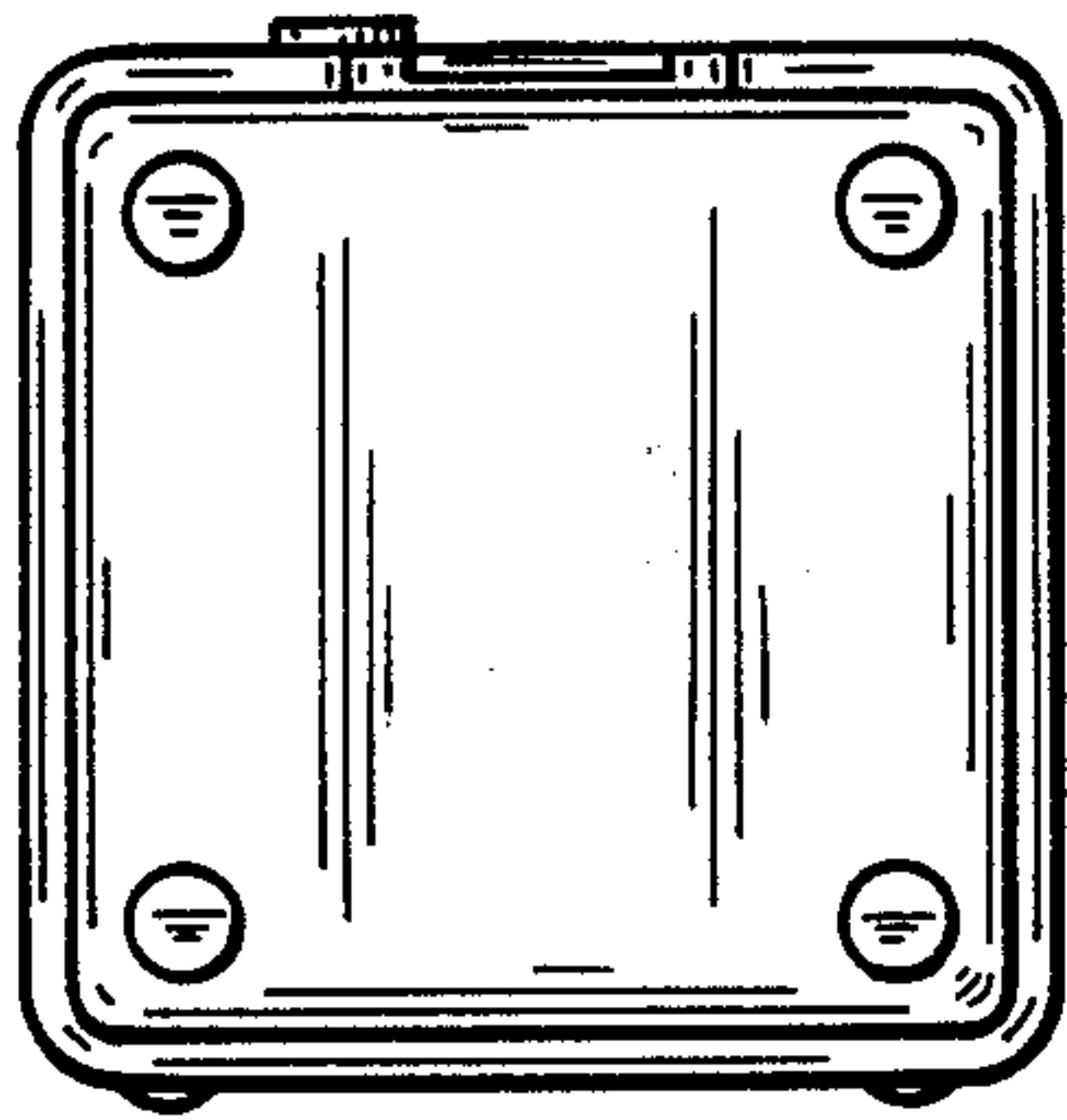
DESCRIPTION

FIG. 1 is a top, front and right side perspective view of a combined tape recorder and radio showing our new design;
FIG. 2 is a front elevational view thereof;
FIG. 3 is a rear elevational view thereof;
FIG. 4 is a top plan view thereof;
FIG. 5 is a bottom plan view thereof;
FIG. 6 is a right side elevational view thereof; and
FIG. 7 is a left side elevational view thereof.

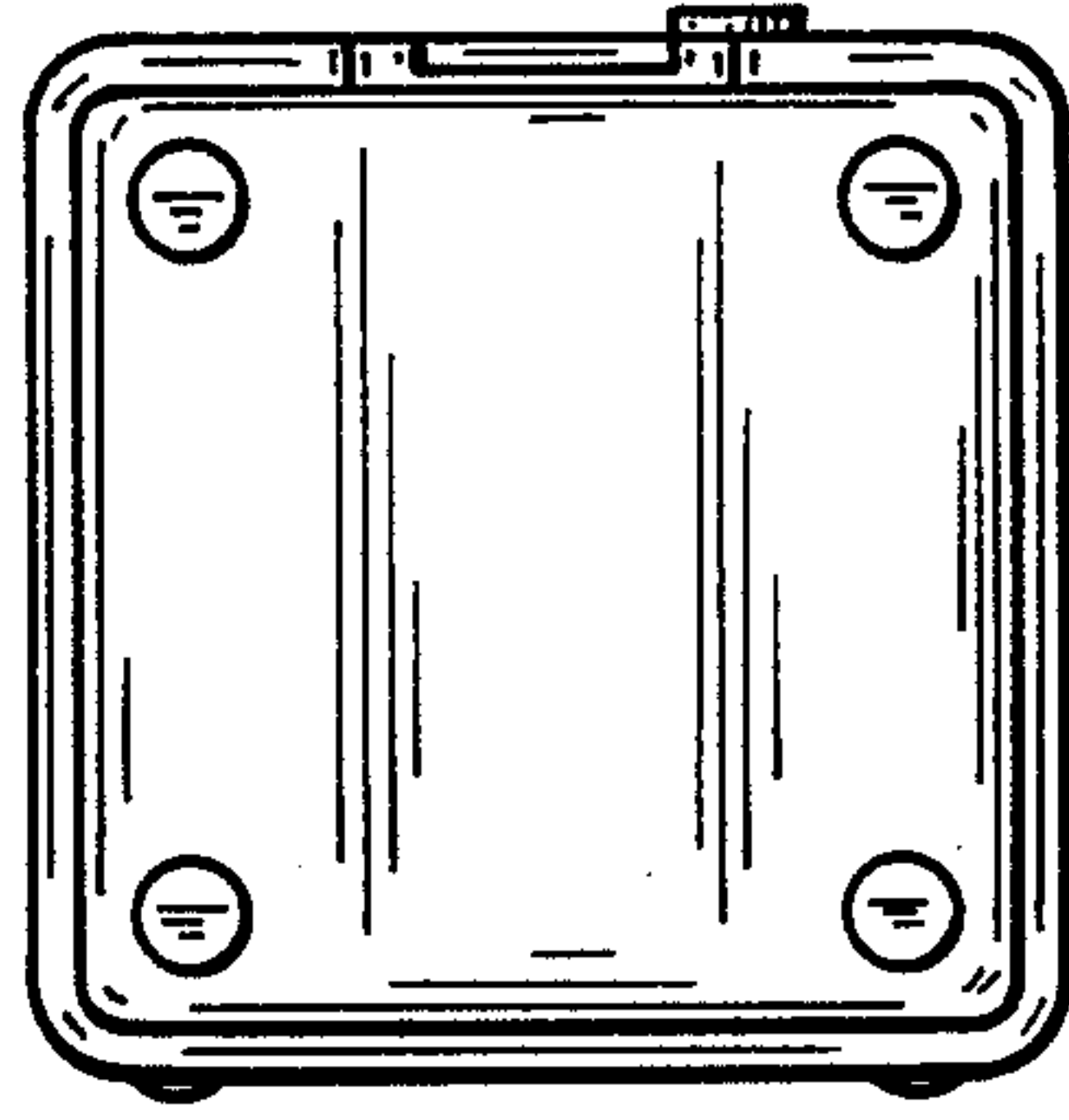




FIG_1



FIG_6



FIG_7

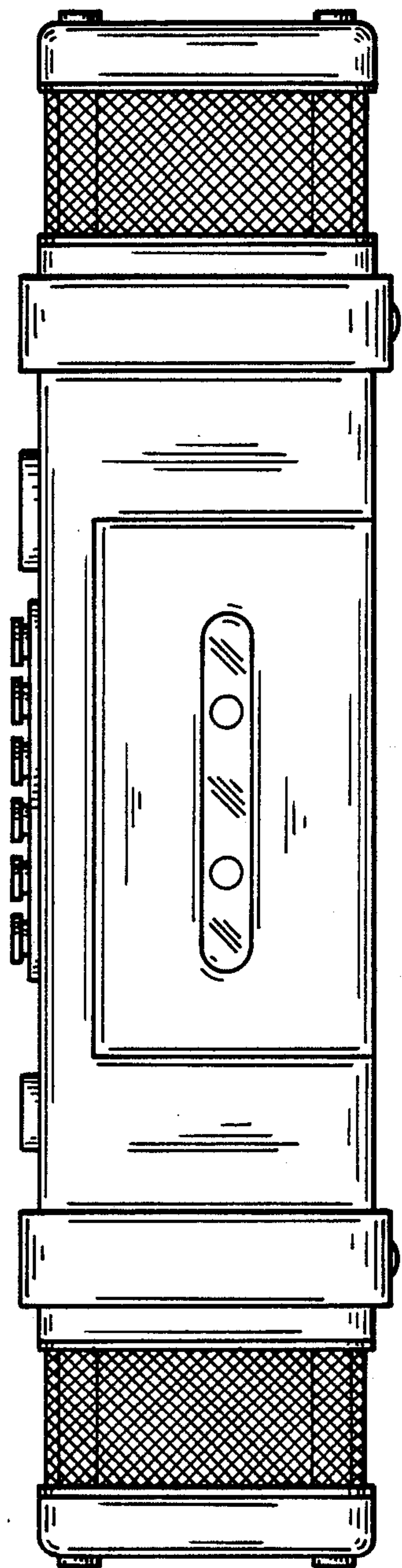


FIG-2

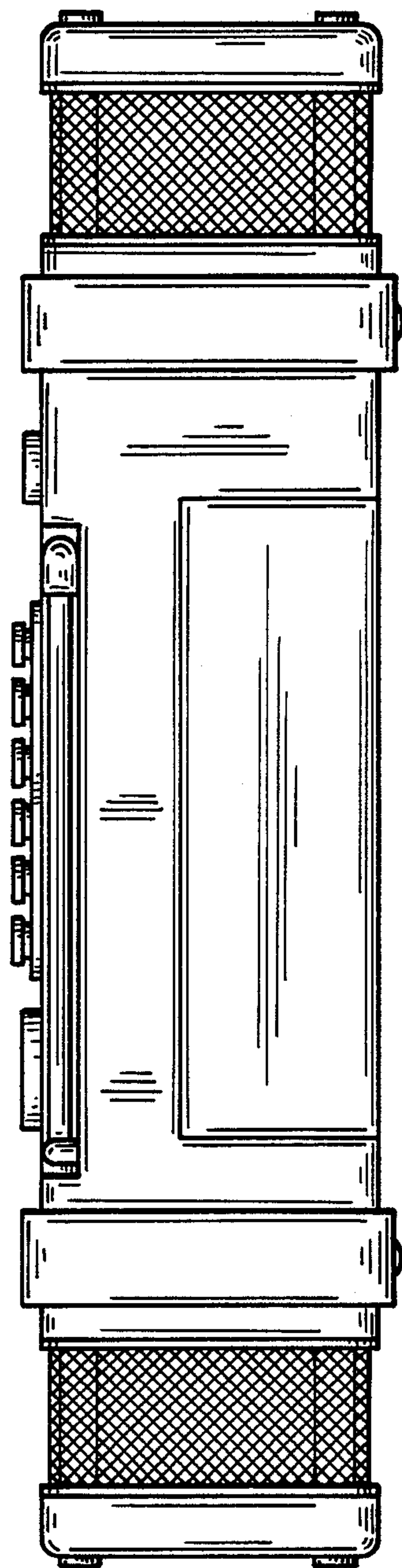


FIG-3

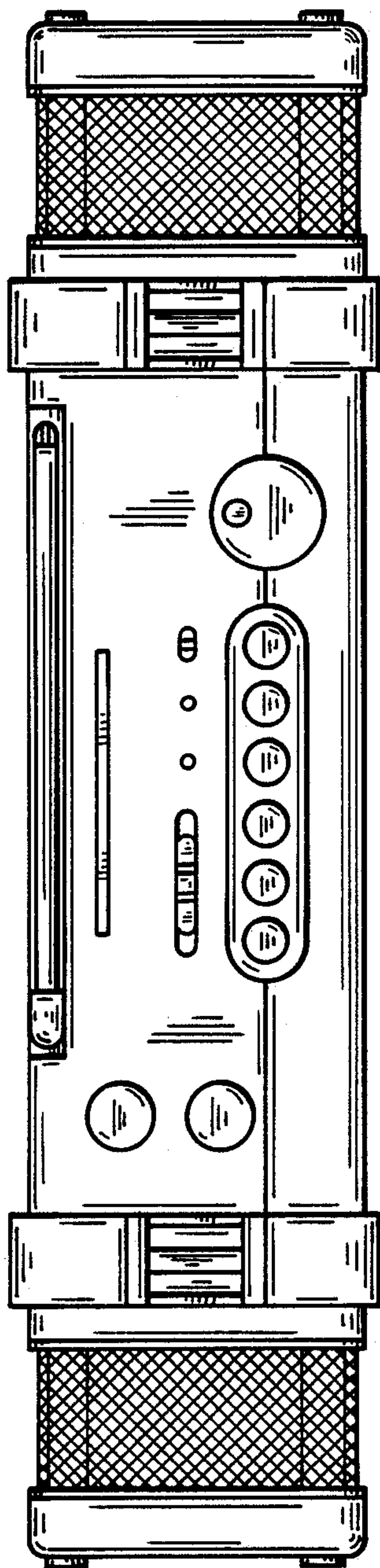


FIG. 4

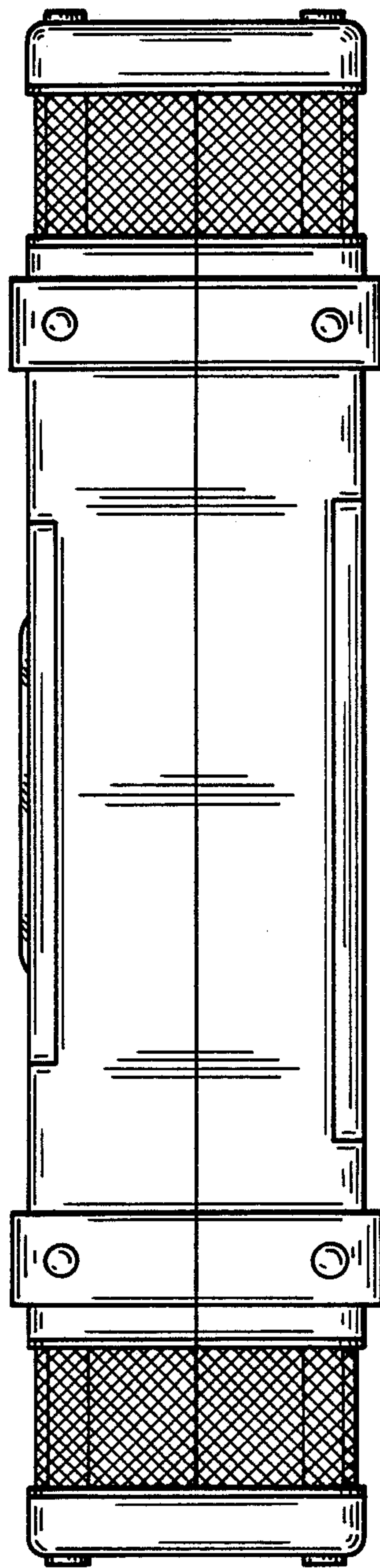


FIG. 5