

[54] MASSAGER FOR A SEAT

[75] Inventor: Yoshikiyo Yamasaki, Osaka, Japan

[73] Assignee: Kabushiki Kaisha Fuji Iryoki, Osaka, Japan

[**] Term: 14 Years

[21] Appl. No.: 21,063

[22] Filed: Mar. 3, 1987

[52] U.S. Cl. D24/36

[58] Field of Search D24/36, 40, 42; 128/46, 128/45, 59, 60, 61

[56] References Cited

U.S. PATENT DOCUMENTS

D. 263,439	3/1982	Grube	D6/596
D. 284,032	5/1986	Wahl et al.	D6/596 X
3,001,523	9/1961	Sugimoto	128/59 X
3,322,117	5/1967	McCaw	128/46 X

Primary Examiner—Wallace R. Burke
Assistant Examiner—S. Reid
Attorney, Agent, or Firm—Flynn, Thiel, Boutell & Tanis

[57] CLAIM

The ornamental design for a massager for a seat, as shown and described.

DESCRIPTION

FIG. 1 is a top plan view of a massager for a seat showing my new design;
FIG. 2 is a bottom plan view thereof;
FIG. 3 is a rear elevational view thereof;
FIG. 4 is a front elevational view thereof;
FIG. 5 is a right end elevational view thereof;
FIG. 6 is a left end elevational view thereof;
FIG. 7 is a perspective view thereof;
FIG. 8 is a cross-sectional view thereof taken along VIII—VIII of FIG. 3; and
FIG. 9 is a cross sectional view thereof taken along line IX—IX of FIG. 3.

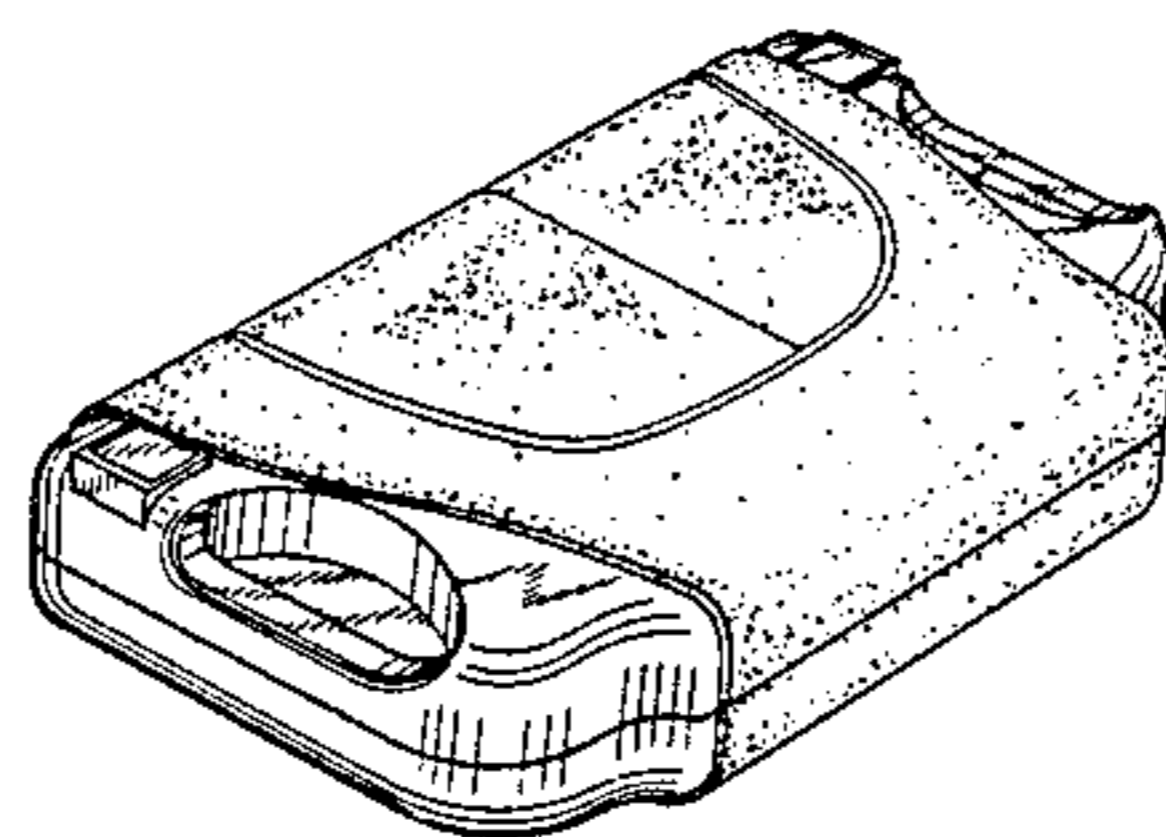

FIG. 1

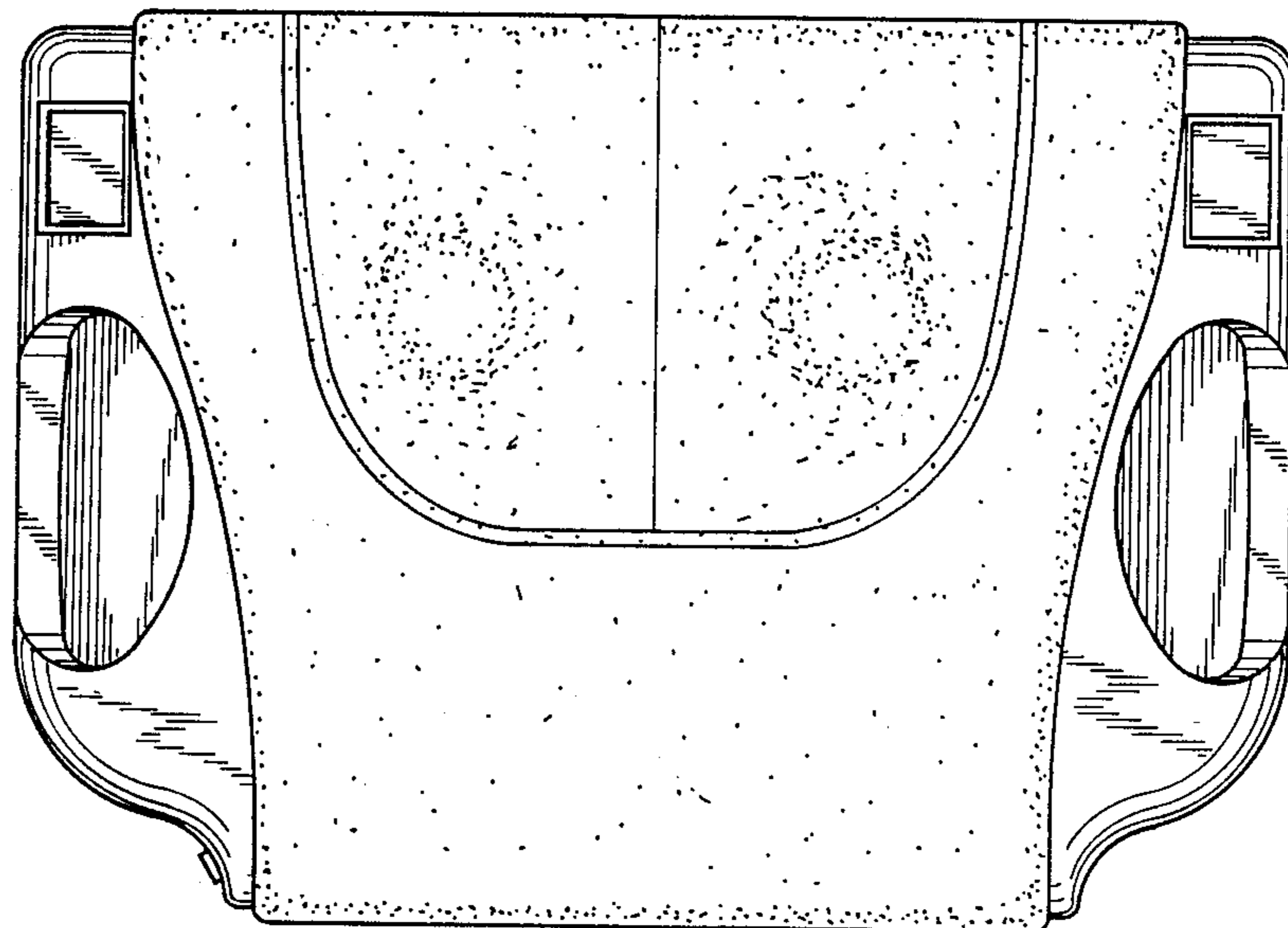

FIG. 2

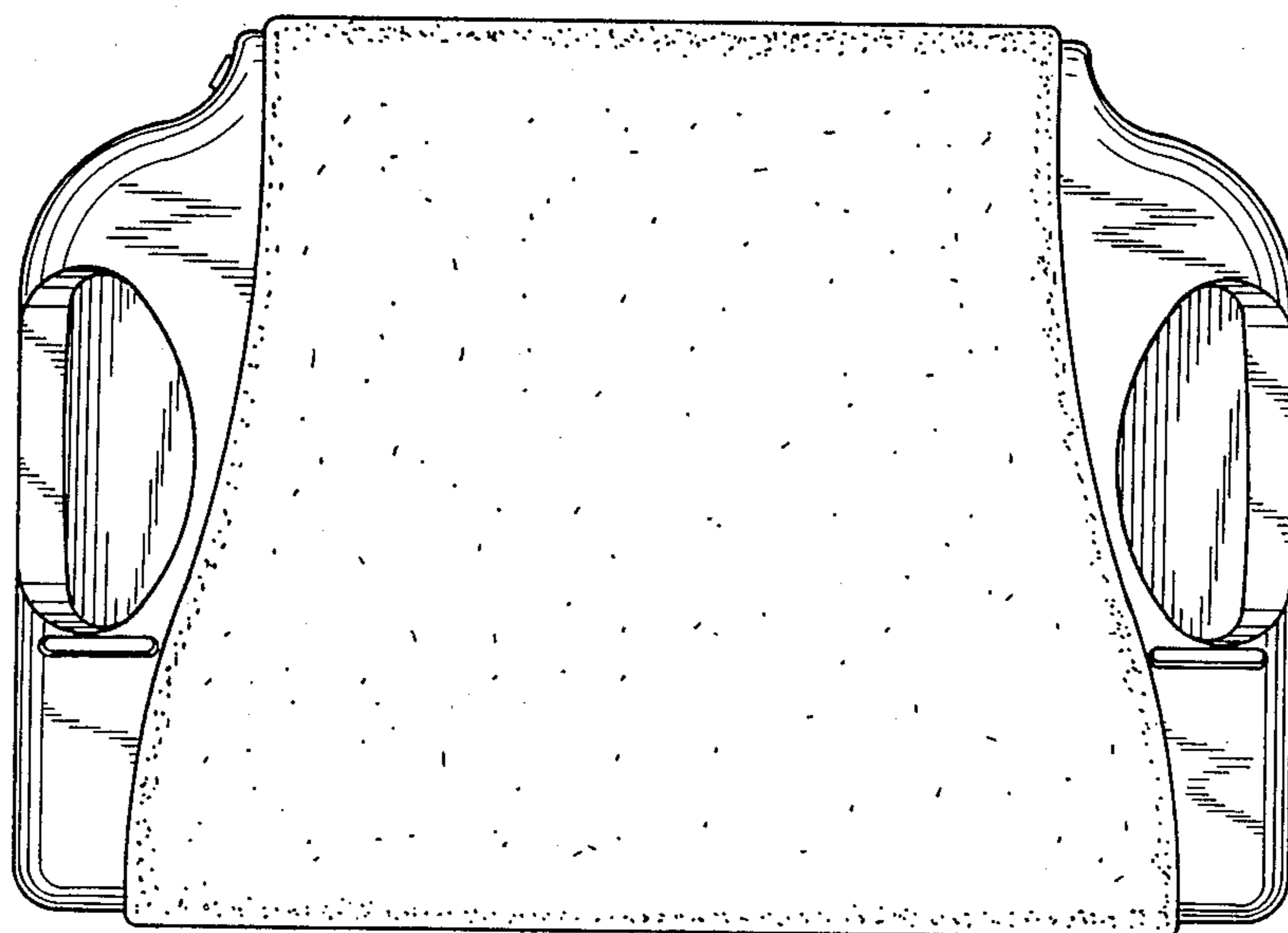

FIG. 3

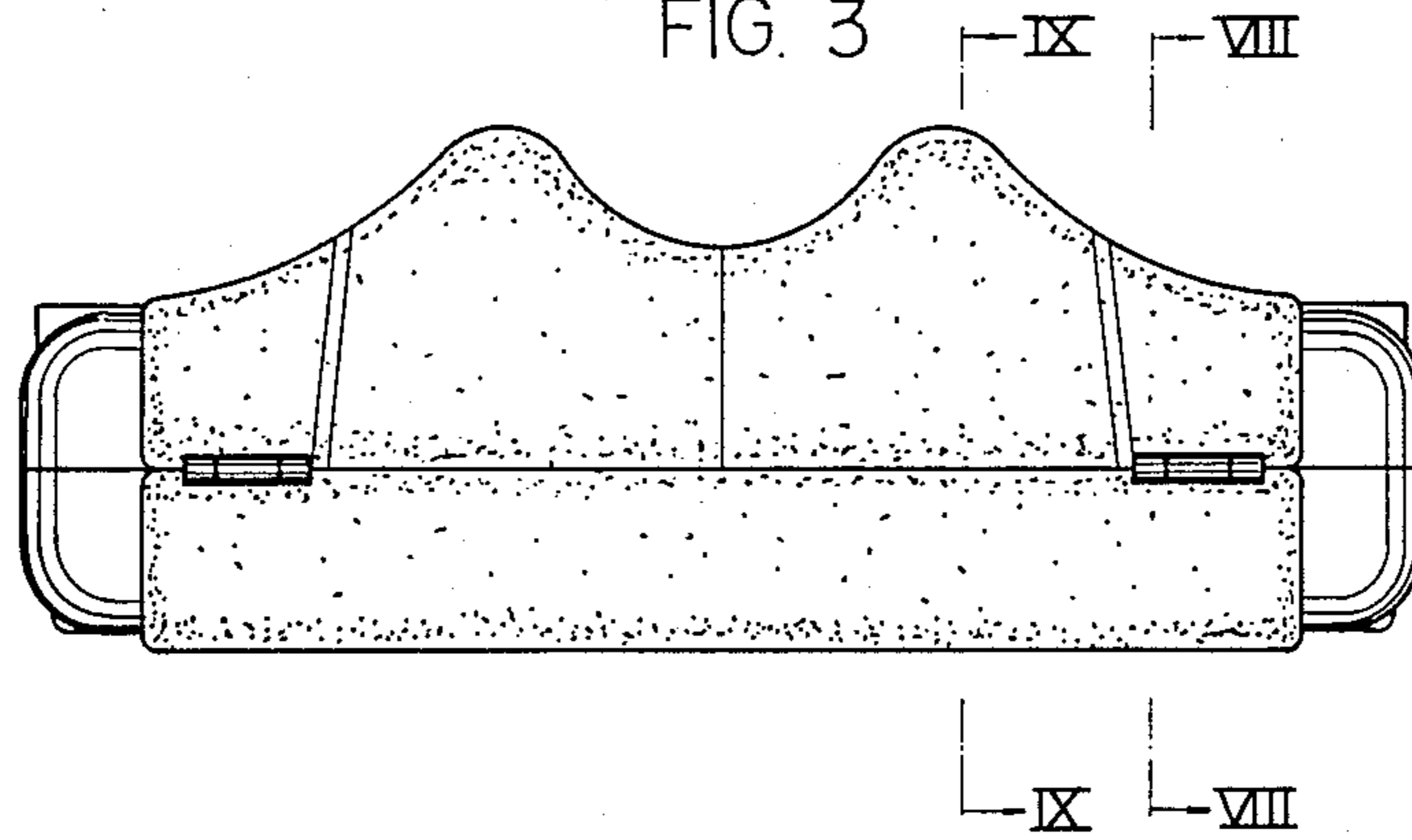

FIG. 4

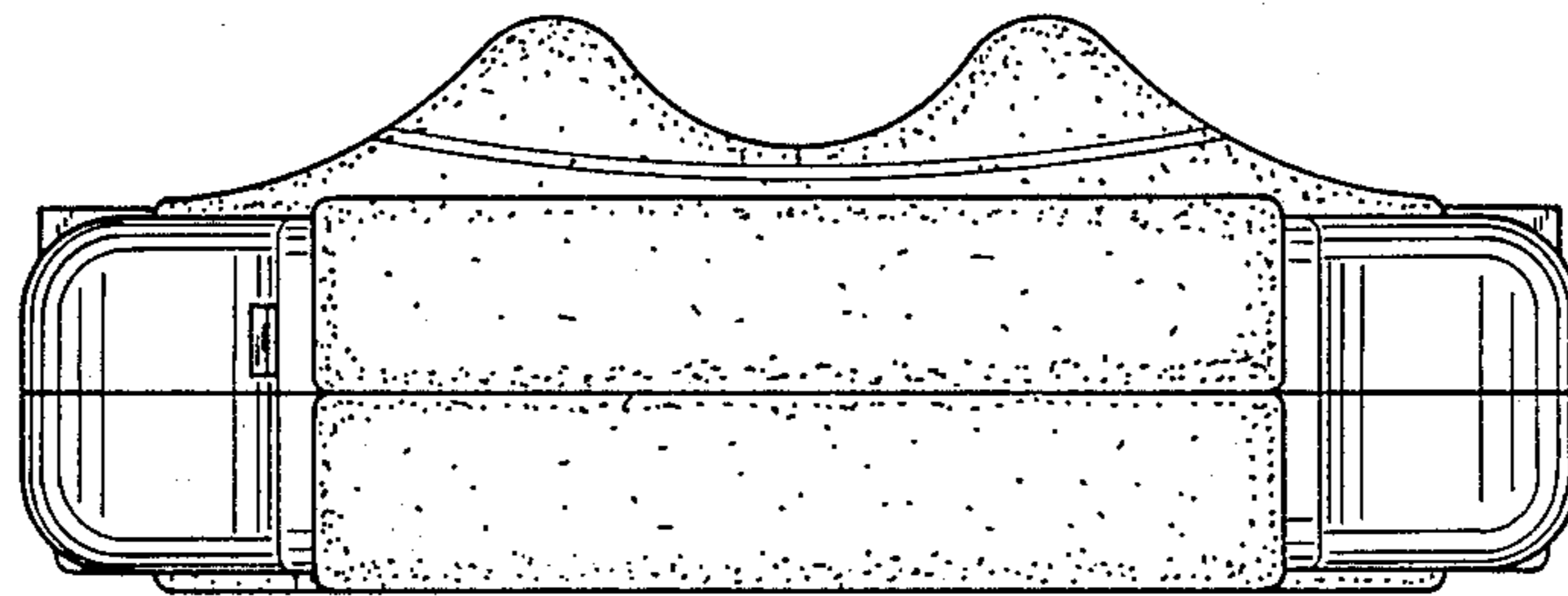

FIG. 5

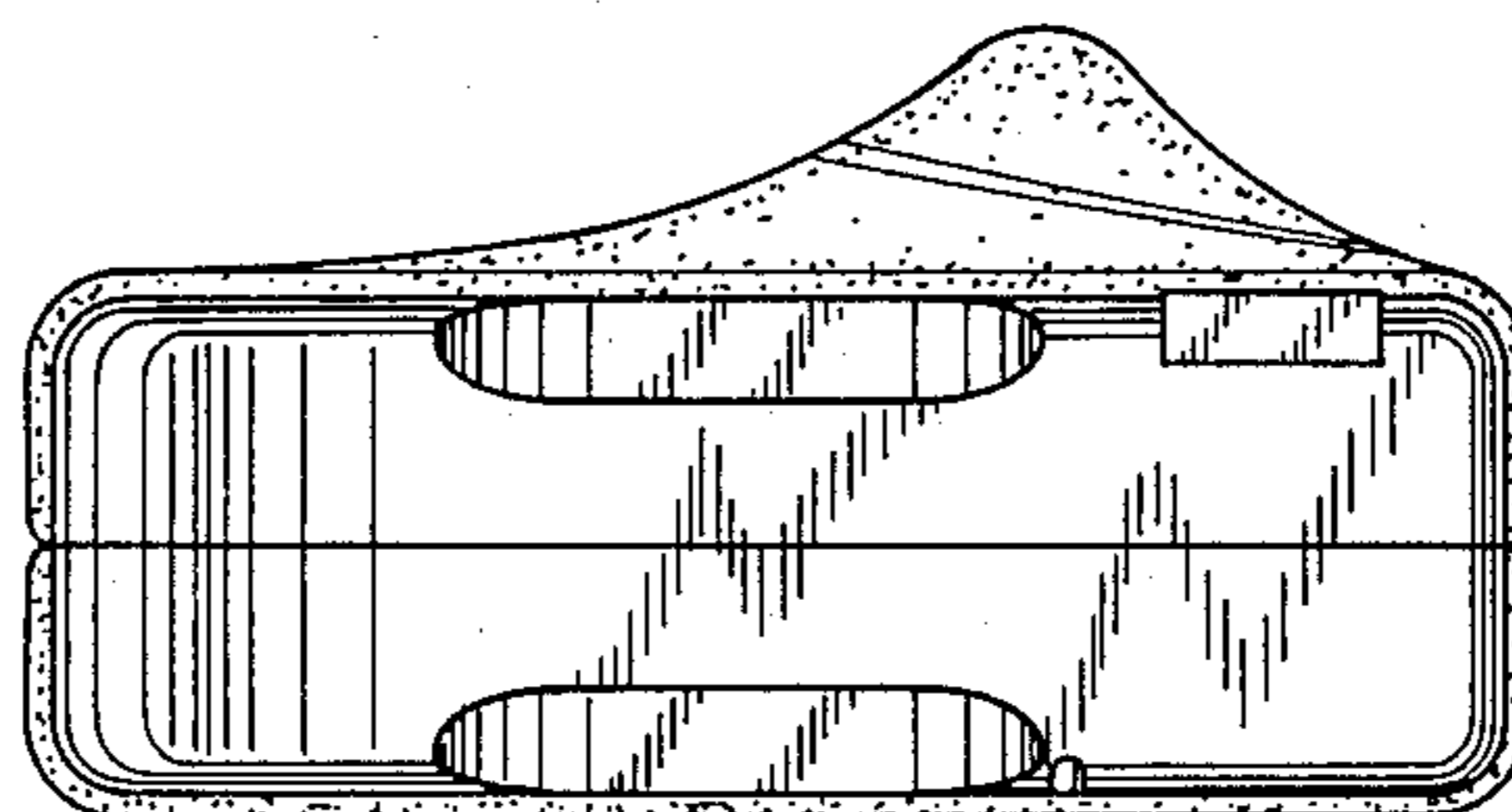

FIG. 6

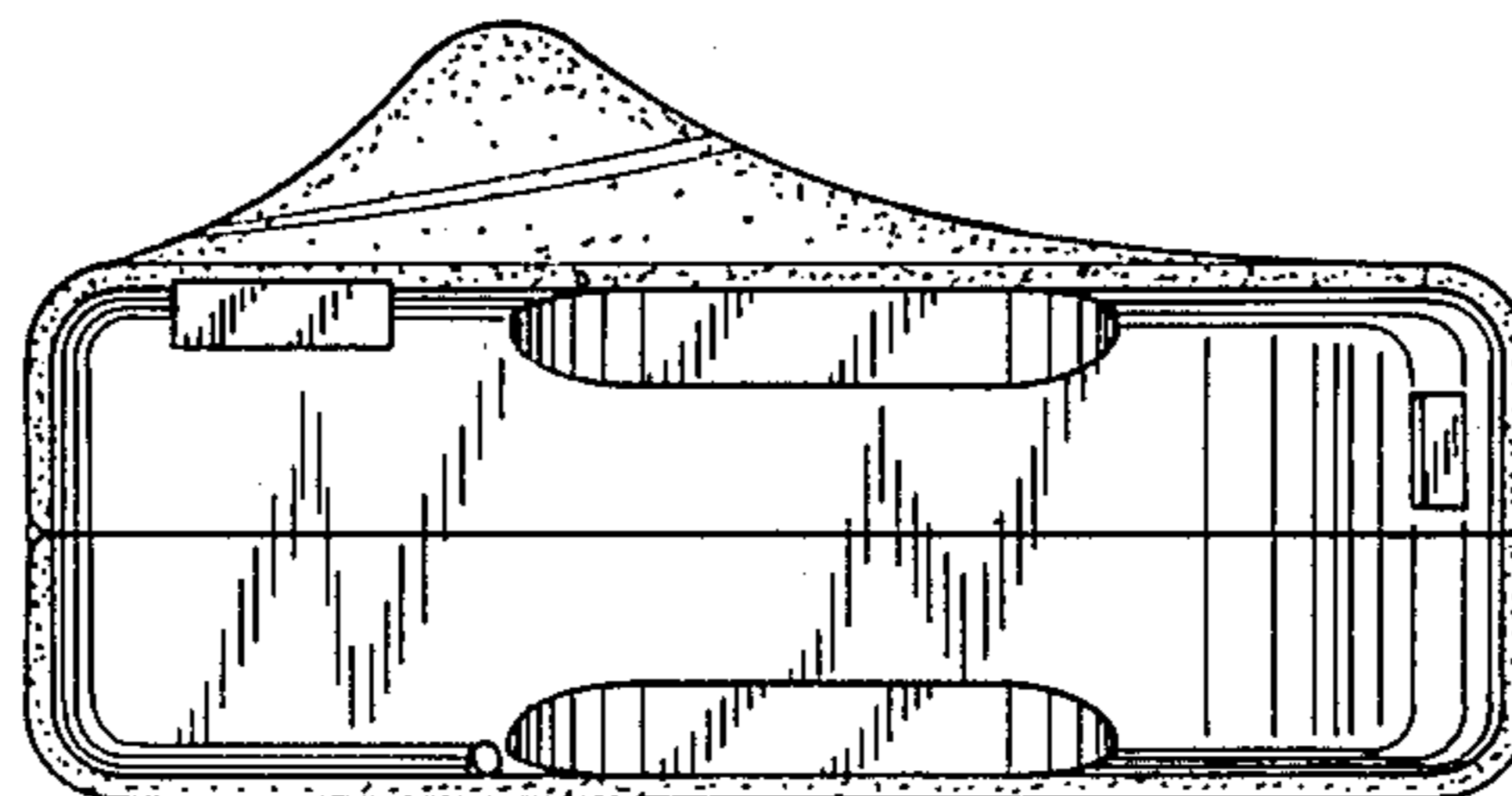

FIG. 7

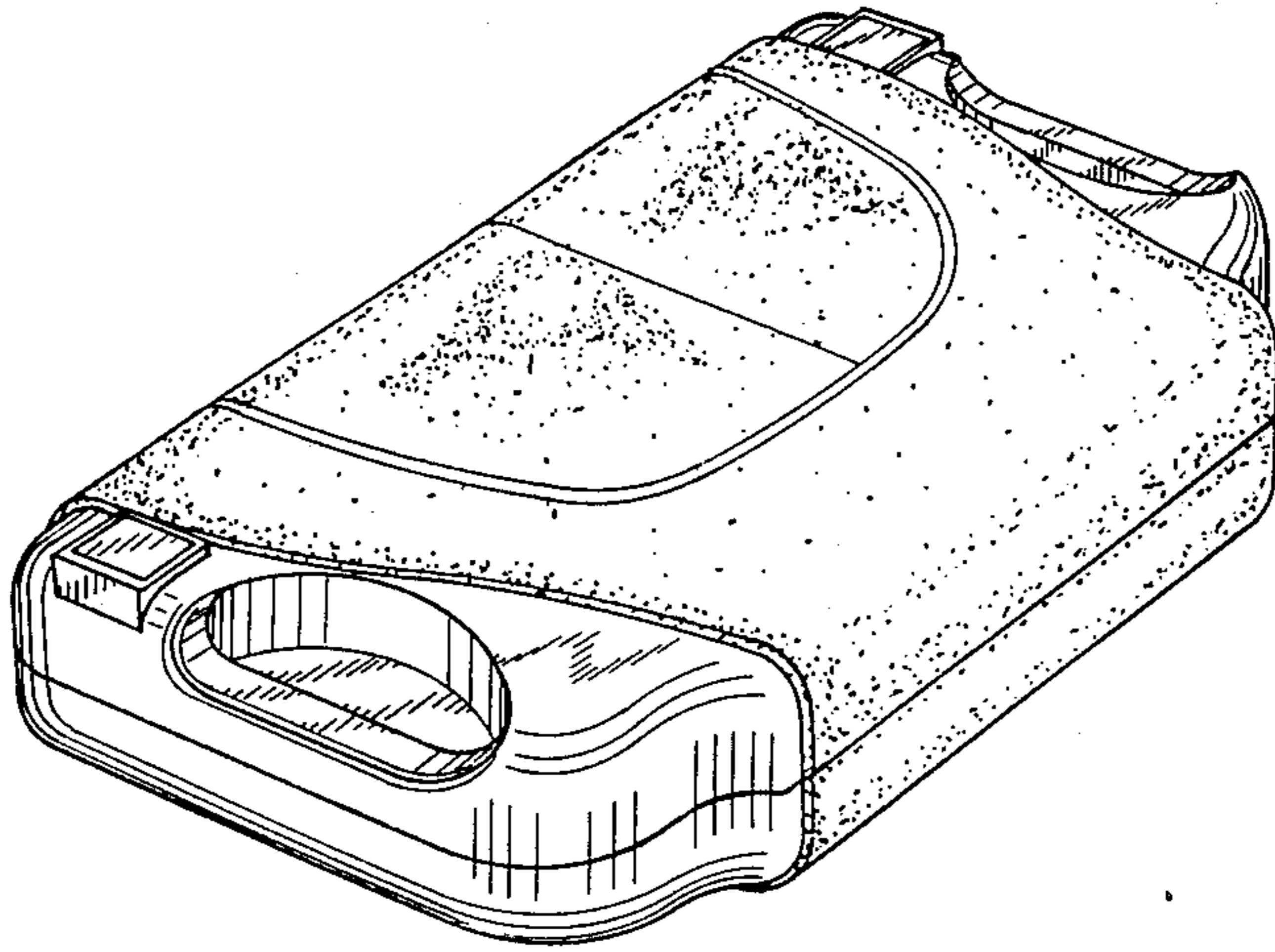

FIG. 8

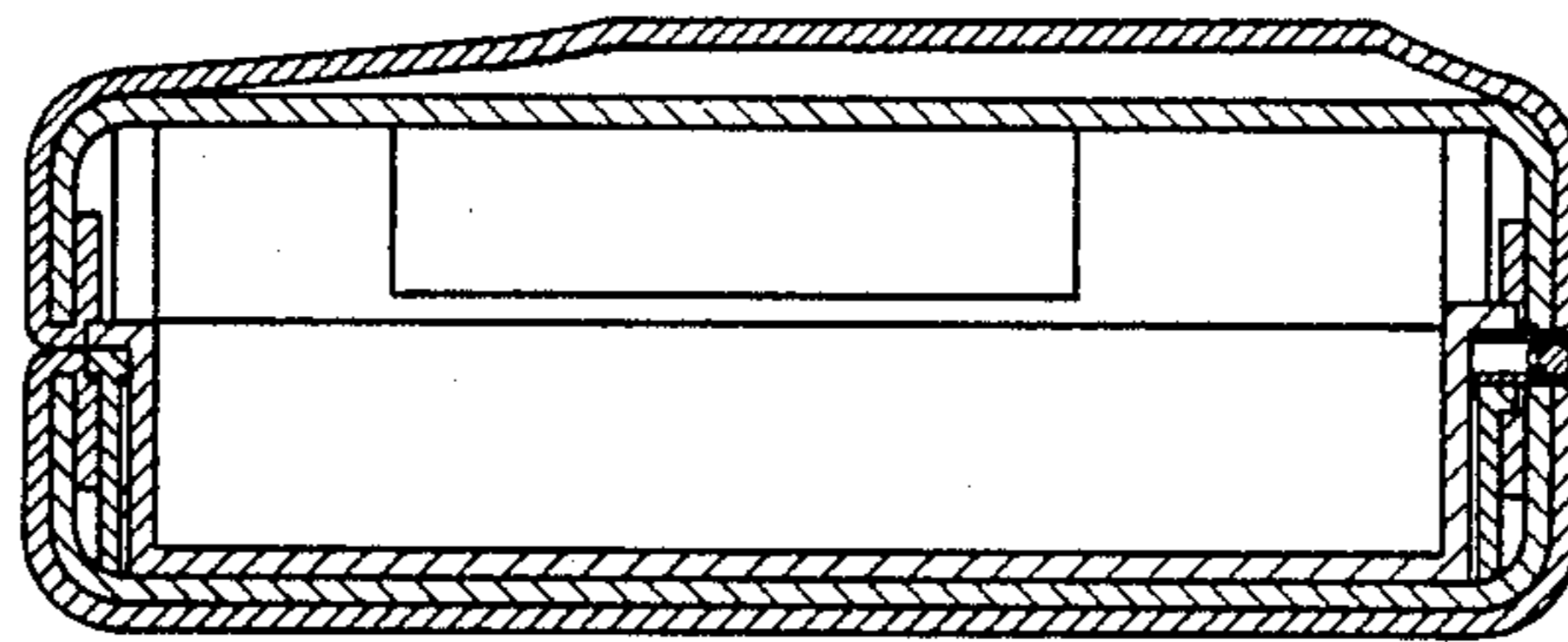

FIG. 9

