

[54] SIMULATIVE TOY SEWING BOX OR SIMILAR ARTICLE

[75] Inventor: Hiroshi Ukisu, Matsudo, Japan

[73] Assignee: Epoch Company, Ltd., Tokyo, Japan

[**] Term: 14 Years

[21] Appl. No.: 131,546

[22] Filed: Dec. 11, 1987

[52] U.S. Cl. D21/59; D3/21; D9/303; D21/109

[58] Field of Search D21/59, 109; D3/20, D3/21; D9/333, 332, 303, 414; 446/71, 73, 75, 80, 475, 483, 487, 489, 491; 434/159, 160, 403; 273/157 R

[56] References Cited

U.S. PATENT DOCUMENTS

D. 10,871 10/1878 Weller et al. D9/333

D. 114,005 3/1939 Blunt D9/333
D. 176,148 11/1955 Krufft D9/303
D. 176,602 1/1956 Durham D3/20
D. 182,018 2/1958 Edwards D3/21

Primary Examiner—Charles A. Rademaker
Attorney, Agent, or Firm—Staas & Halsey

[57] CLAIM

The ornamental design for a simulative toy sewing box or similar article, as shown and described.

DESCRIPTION

FIG. 1 is a front elevational view of a simulative toy sewing box or similar article showing my new design; FIG. 2 is a right side elevational view thereof; FIG. 3 is a rear elevational view thereof; FIG. 4 is a left side elevational view thereof; FIG. 5 is a bottom plan view thereof; FIG. 6 is a top plan view thereof; and FIG. 7 is a perspective view thereof with portions of the design in alternate positions.

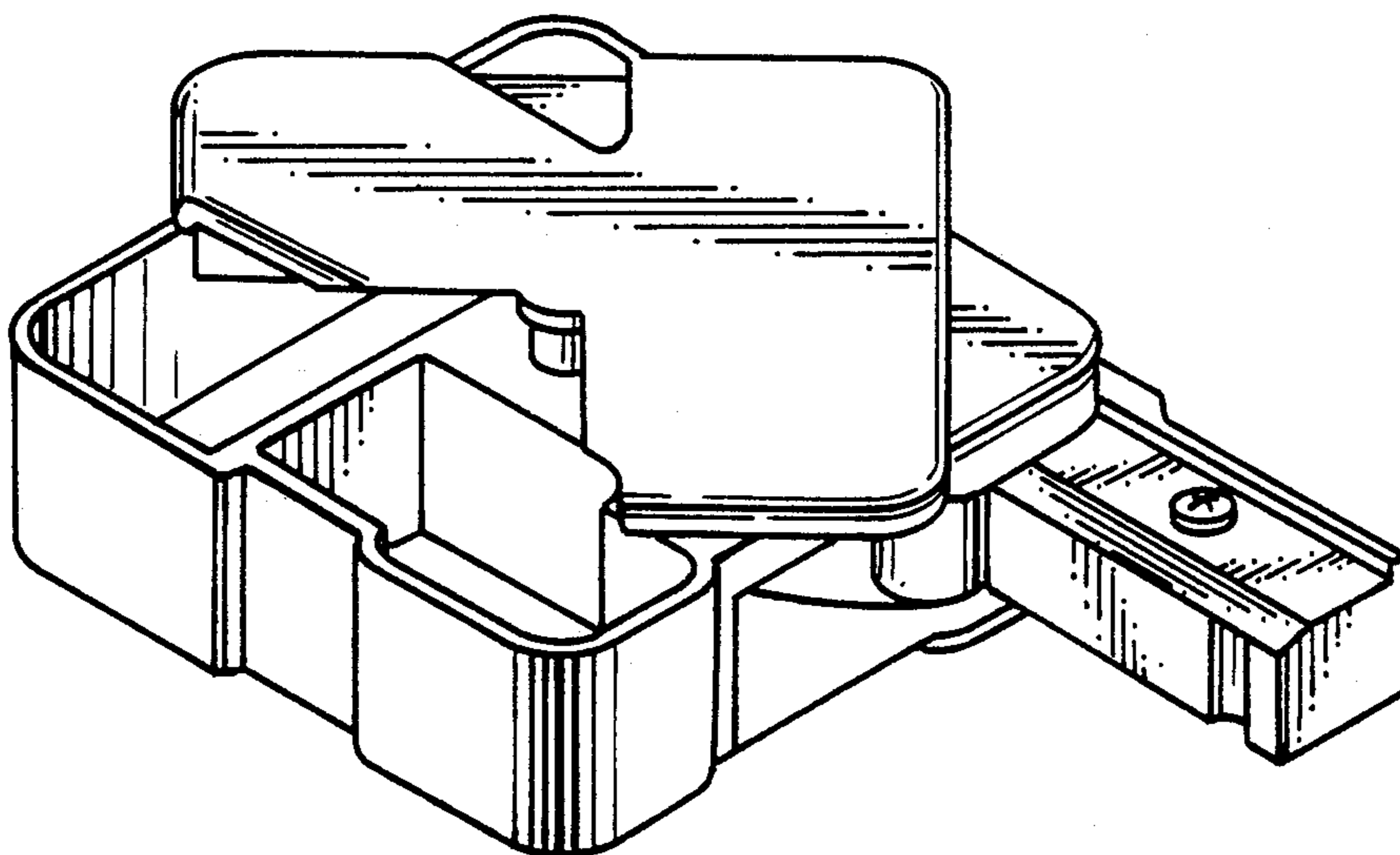

FIG. 1.

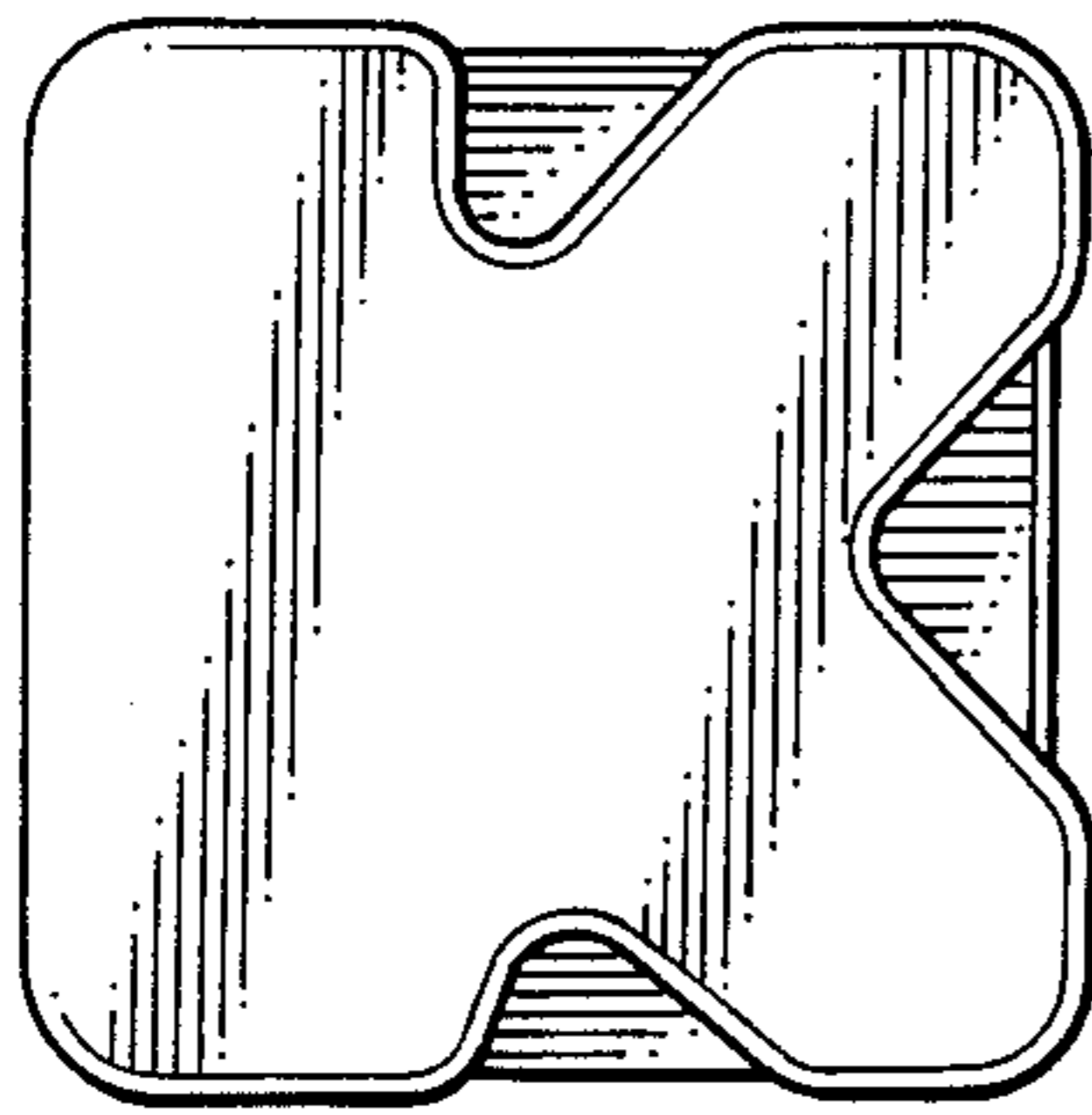

FIG. 2.

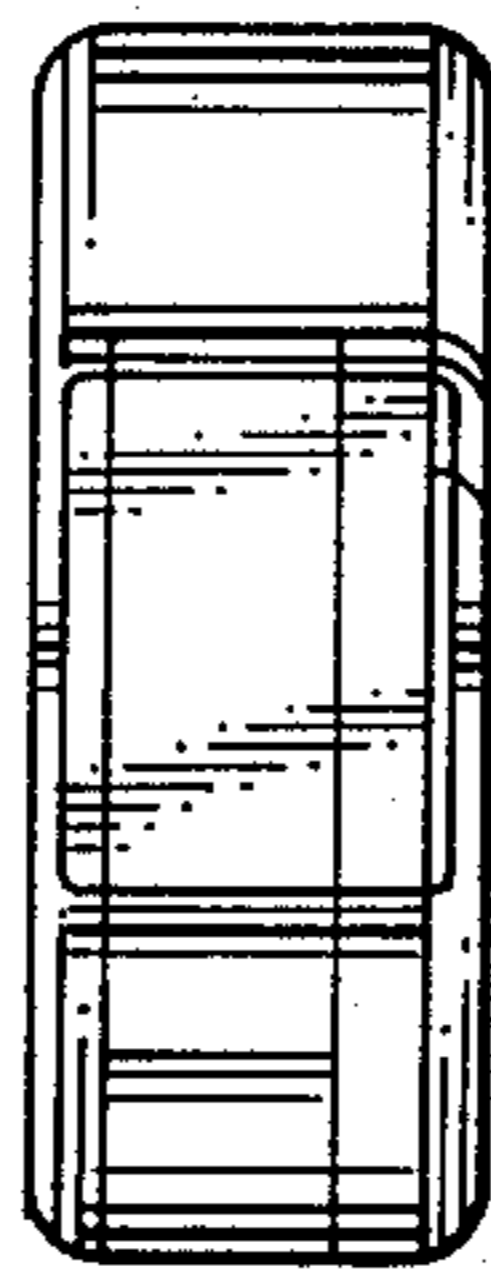

FIG. 3.

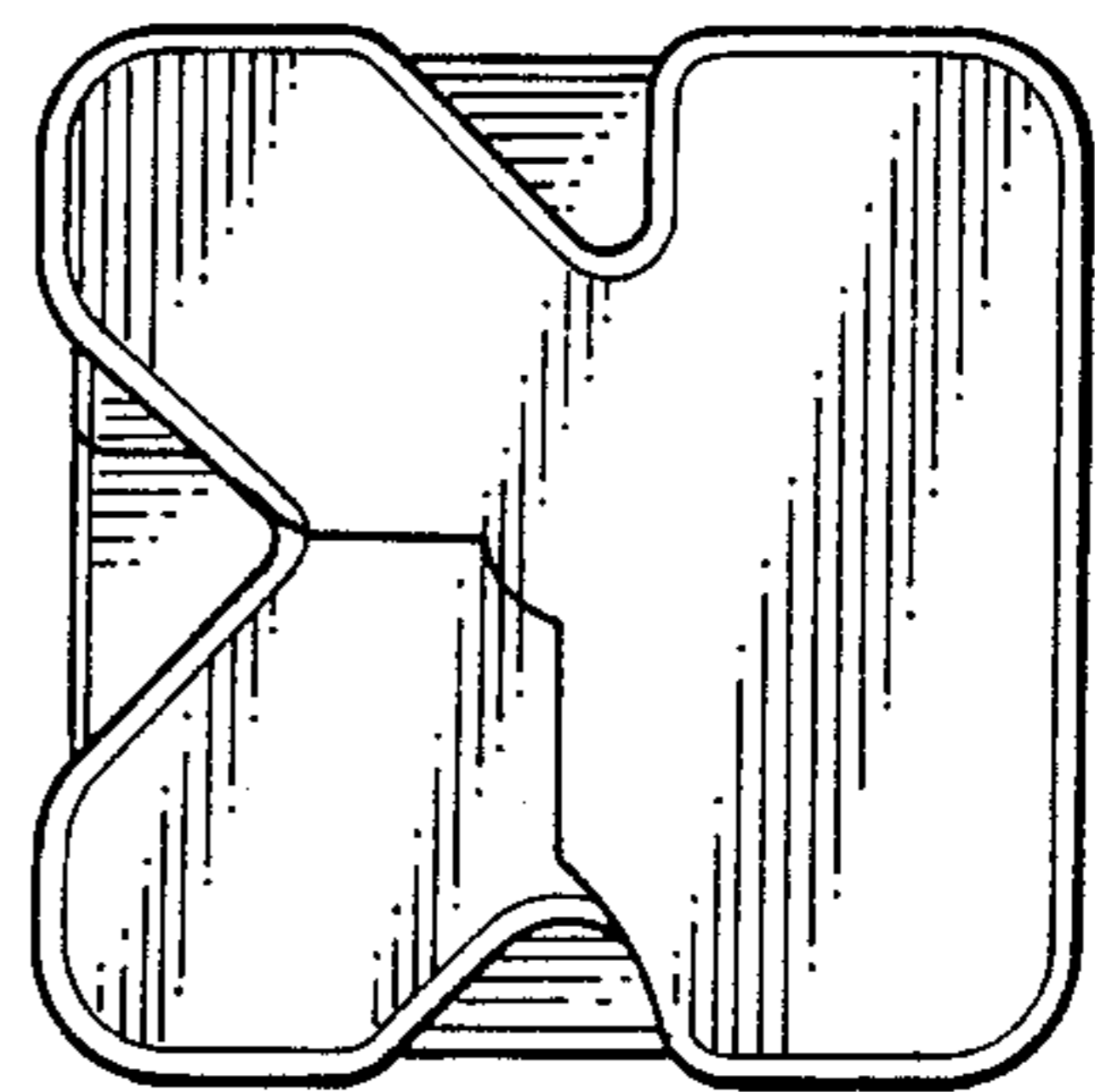

FIG. 4.

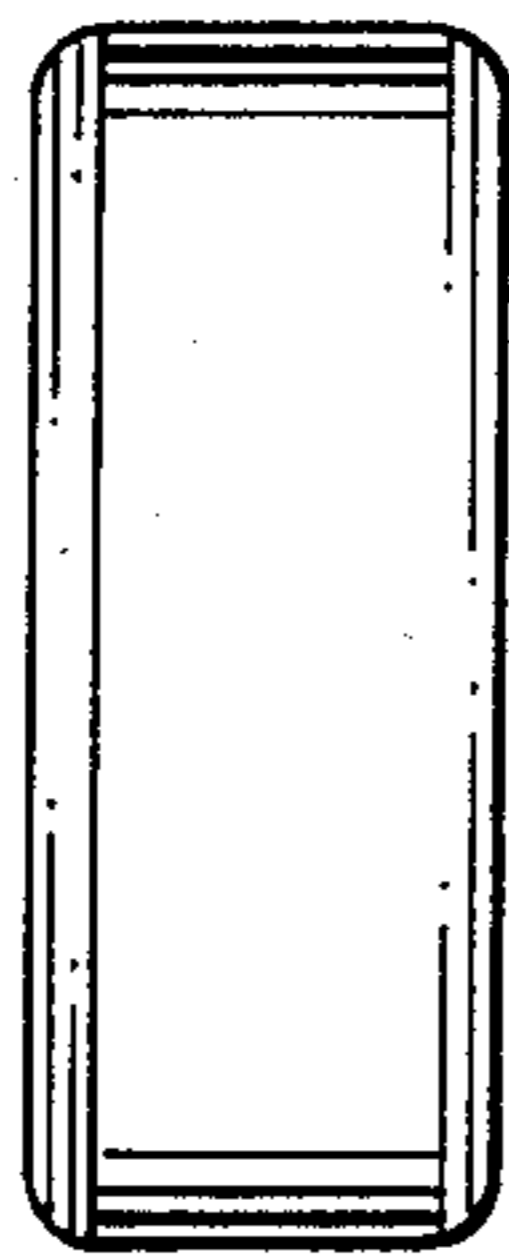

FIG. 5.

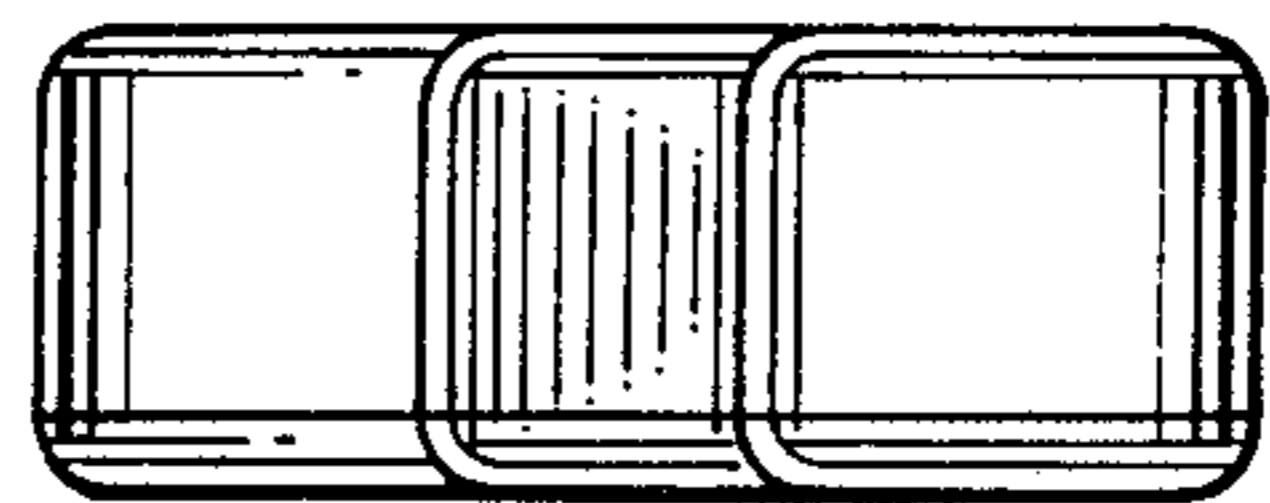

FIG. 6.

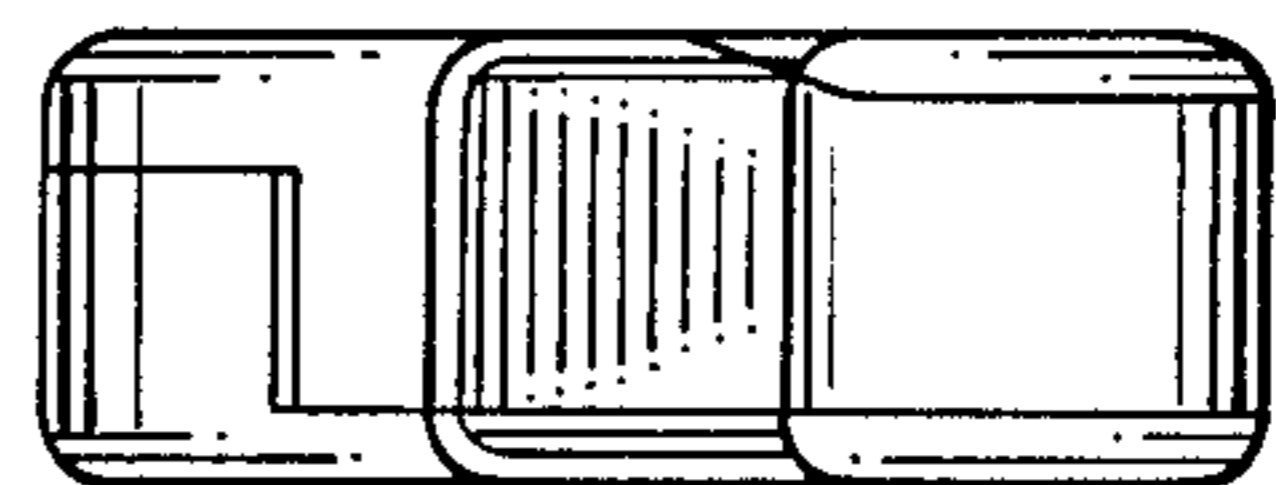

FIG. 7.

