

- [54] DESK
- [75] Inventor: Thomas J. Newhouse, Grand Rapids, Mich.
- [73] Assignee: Herman Miller, Inc., Zeeland, Mich.
- [**] Term: 14 Years
- [21] Appl. No.: 57,824
- [22] Filed: Jun. 2, 1987
- [52] U.S. Cl. D6/420; D6/428; D6/440; D6/443
- [58] Field of Search D6/419-431, D6/338, 340, 440, 441, 443, 480; 108/94; 312/114, 223

- 4,323,291 4/1982 Ball .
- 4,372,631 2/1983 Leon .
- 4,555,150 11/1985 Turnbull .

OTHER PUBLICATIONS

Modern Office Technology, May, 1985, p. 106, item in lower left corner of pg.

Primary Examiner—Carmen H. Vales-Lado
 Assistant Examiner—Schon C. Oppert
 Attorney, Agent, or Firm—Varnum, Riddering, Schmidt & Howlett

[56] References Cited

U.S. PATENT DOCUMENTS

- D. 159,992 9/1950 Kump, Jr. D6/338
- D. 168,659 1/1953 Silverman D6/340
- D. 239,350 3/1976 Vogt .
- D. 281,299 11/1985 Esslinger .
- 1,652,774 12/1927 Fraser et al. 108/1 X
- 3,635,174 1/1972 Ball et al. .
- 3,786,765 1/1974 Burr .
- 3,806,220 4/1974 Payne 312/233 X
- 4,296,981 10/1981 Hildebrandt et al. .

[57] CLAIM

The ornamental design for desk, as shown and described.

DESCRIPTION

FIG. 1 is a top perspective view of the desk showing my new design;
 FIG. 2 is a front elevational view thereof;
 FIG. 3 is a rear elevational view thereof;
 FIG. 4 is a right side elevational view, the left side being a mirror image thereof;
 FIG. 5 is a top plan view thereof; and
 FIG. 6 is a top perspective view showing the top in open condition thereof.

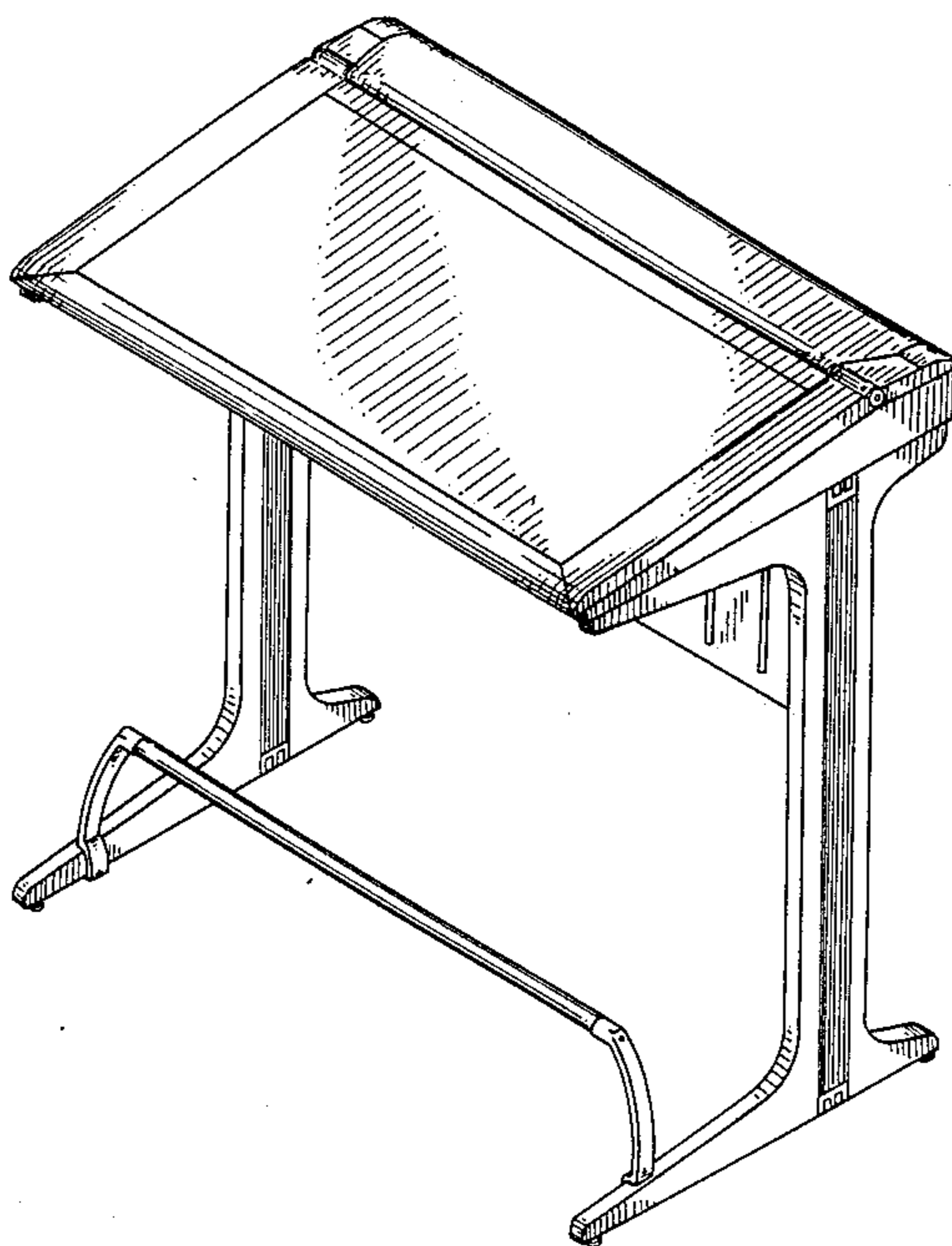

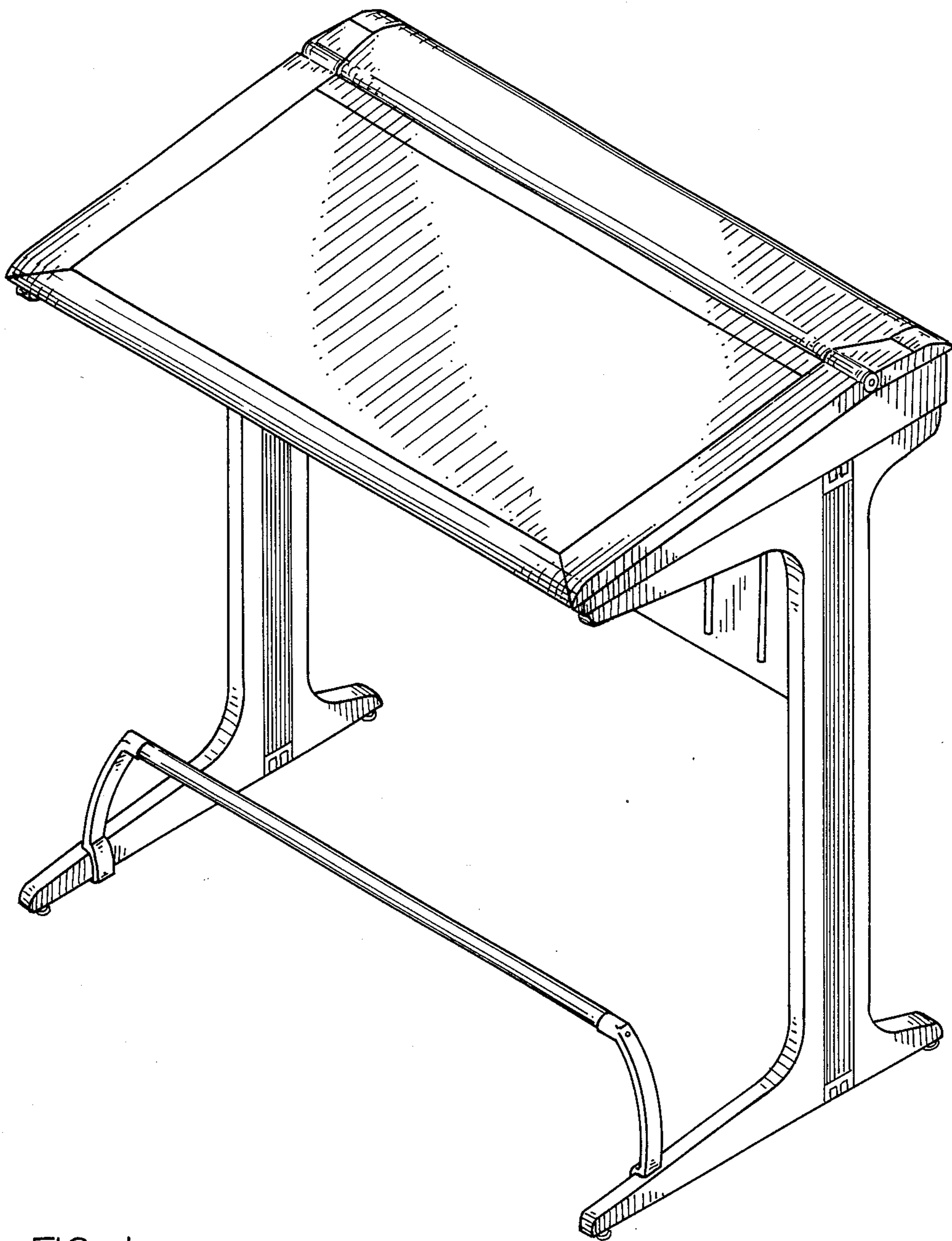

FIG. 1

UNITED STATES PATENT AND TRADEMARK OFFICE
CERTIFICATE OF CORRECTION

Page 1 of 4

PATENT NO. : D-306,105
DATED : February 20, 1990
INVENTOR(S) : THOMAS J. NEWHOUSE

It is certified that error appears in the above-identified patent and that said Letters Patent is hereby corrected as shown below:

Figures 2 thru 6 should be added as shown on the attached sheets.

**Signed and Sealed this
Thirtieth Day of July, 1991**

Attest:

Attesting Officer

HARRY F. MANBECK, JR.

Commissioner of Patents and Trademarks

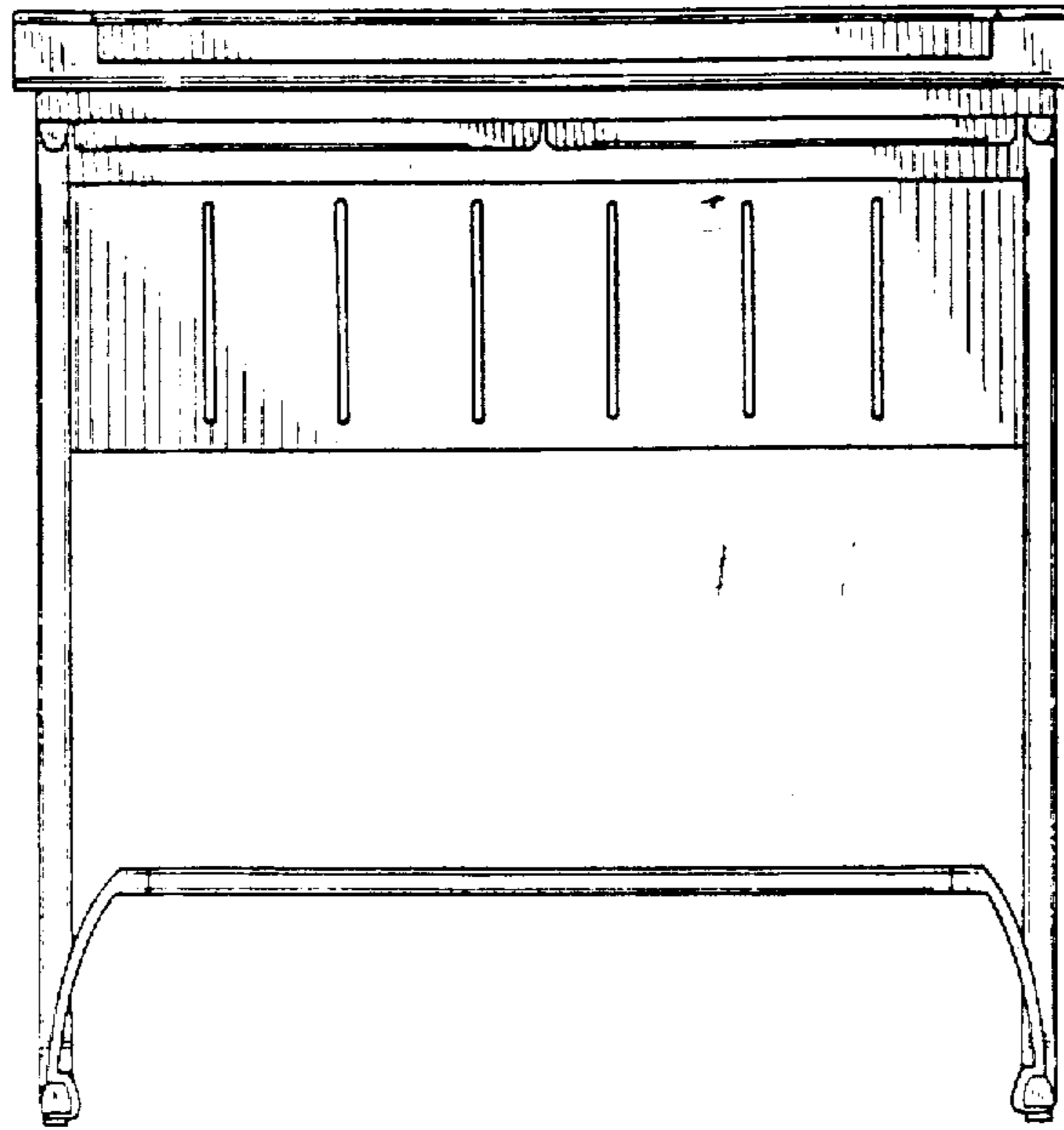

FIG. 2

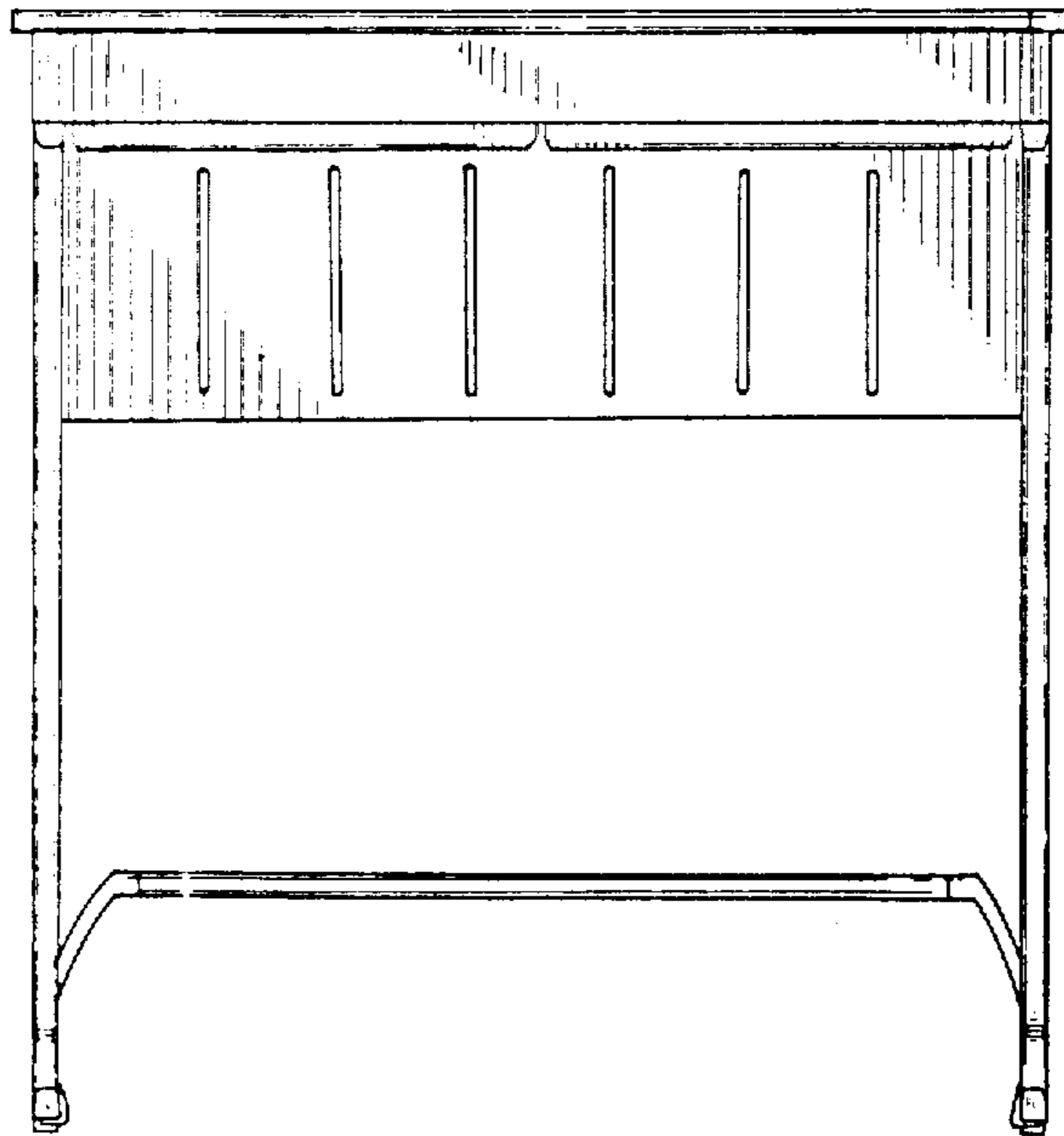

FIG 3

Patent No. D-306,105

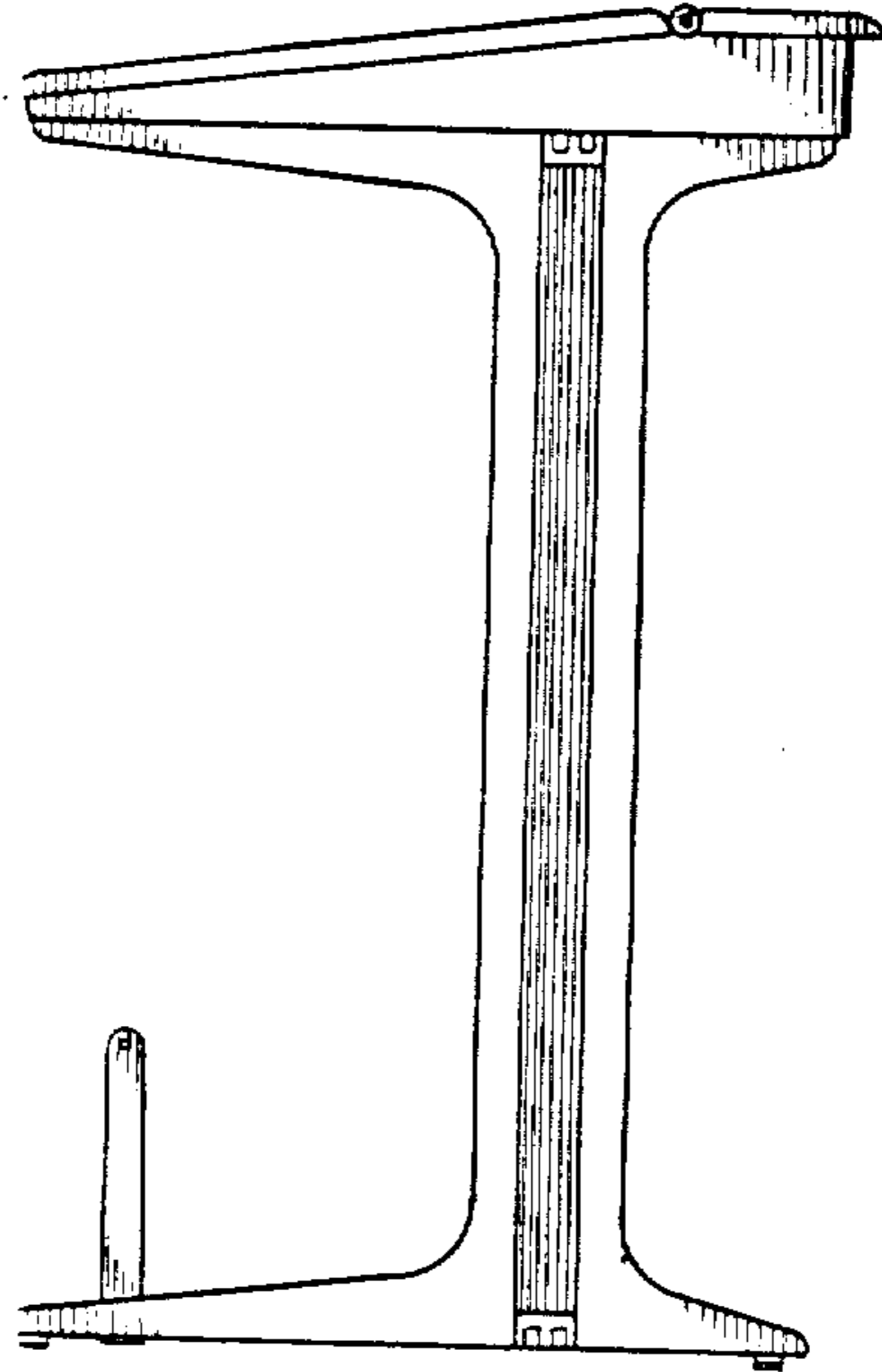

FIG. 4

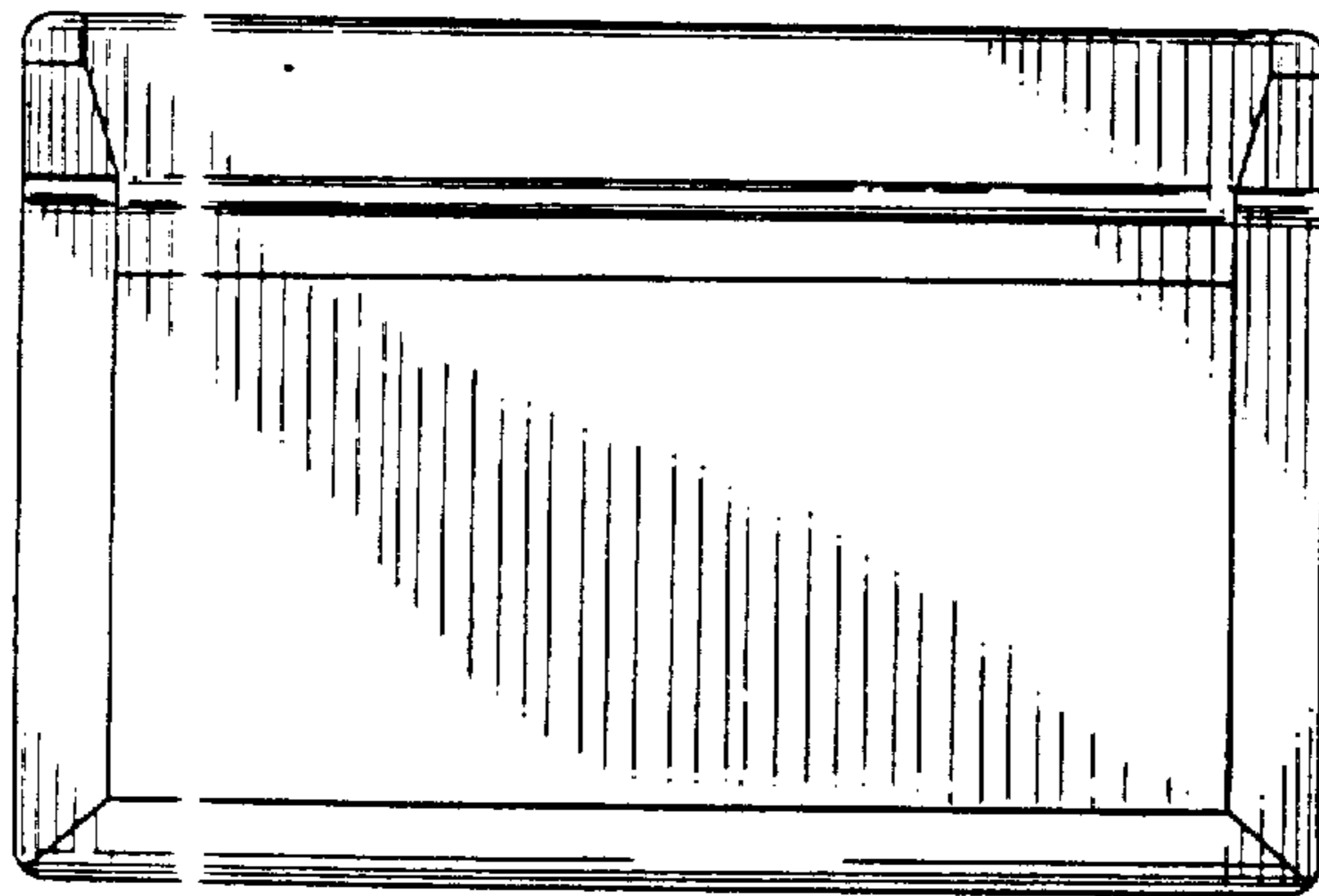

FIG. 5

Patent No. D-306-105

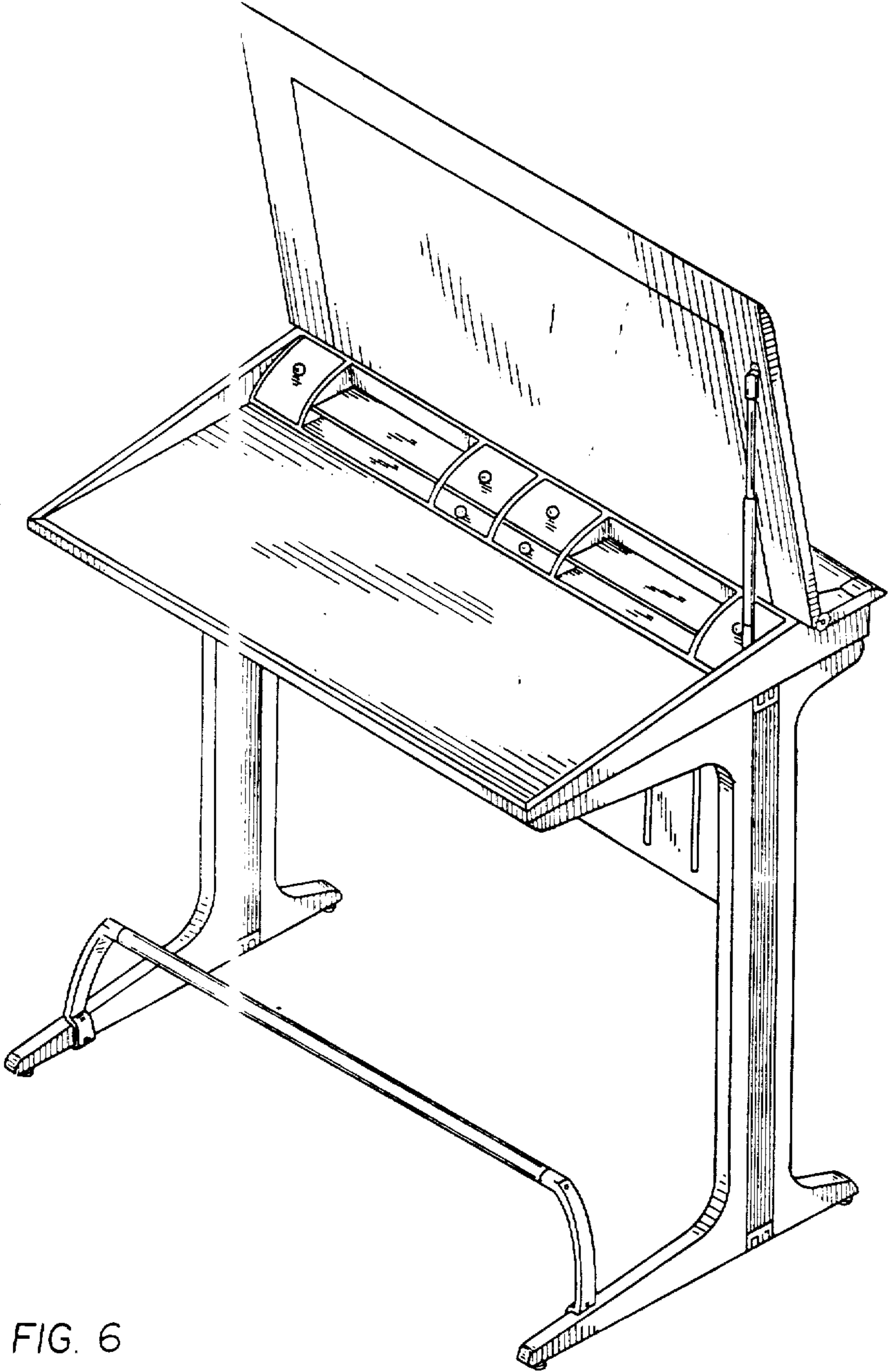

FIG. 6