

[54] UMBRELLA

[75] Inventor: Karl D. Lerch, East Aurora, N.Y.

[73] Assignee: The Quaker Oats Company, Chicago, Ill.

[**] Term: 14 Years

[21] Appl. No.: 70,885

[22] Filed: Jul. 8, 1987

[52] U.S. Cl. D3/5

[58] Field of Search D3/1-17;
362/102; 135/16, 17, 19.5, 20 R, 20 A, 20 M,
24, 25 R, 39 R, 33 C, 34, DIG. 10

[56] References Cited

U.S. PATENT DOCUMENTS

D. 28,465 4/1898 Brown D3/11
D. 289,945 5/1987 Orenstein D3/5

Primary Examiner—Louis S. Zarfes
Attorney, Agent, or Firm—Cumpston & Shaw

[57] CLAIM

The ornamental design for an umbrella, as shown and described.

DESCRIPTION

FIG. 1 is a front elevational view of an umbrella showing my new design;
FIG. 2 is a partial right-side elevational view thereof;
FIG. 3 is a partial left-side elevational view thereof;
FIG. 4 is a partial rear elevational view thereof;
FIG. 5 is a bottom plan view thereof; and
FIG. 6 is a top plan view thereof.

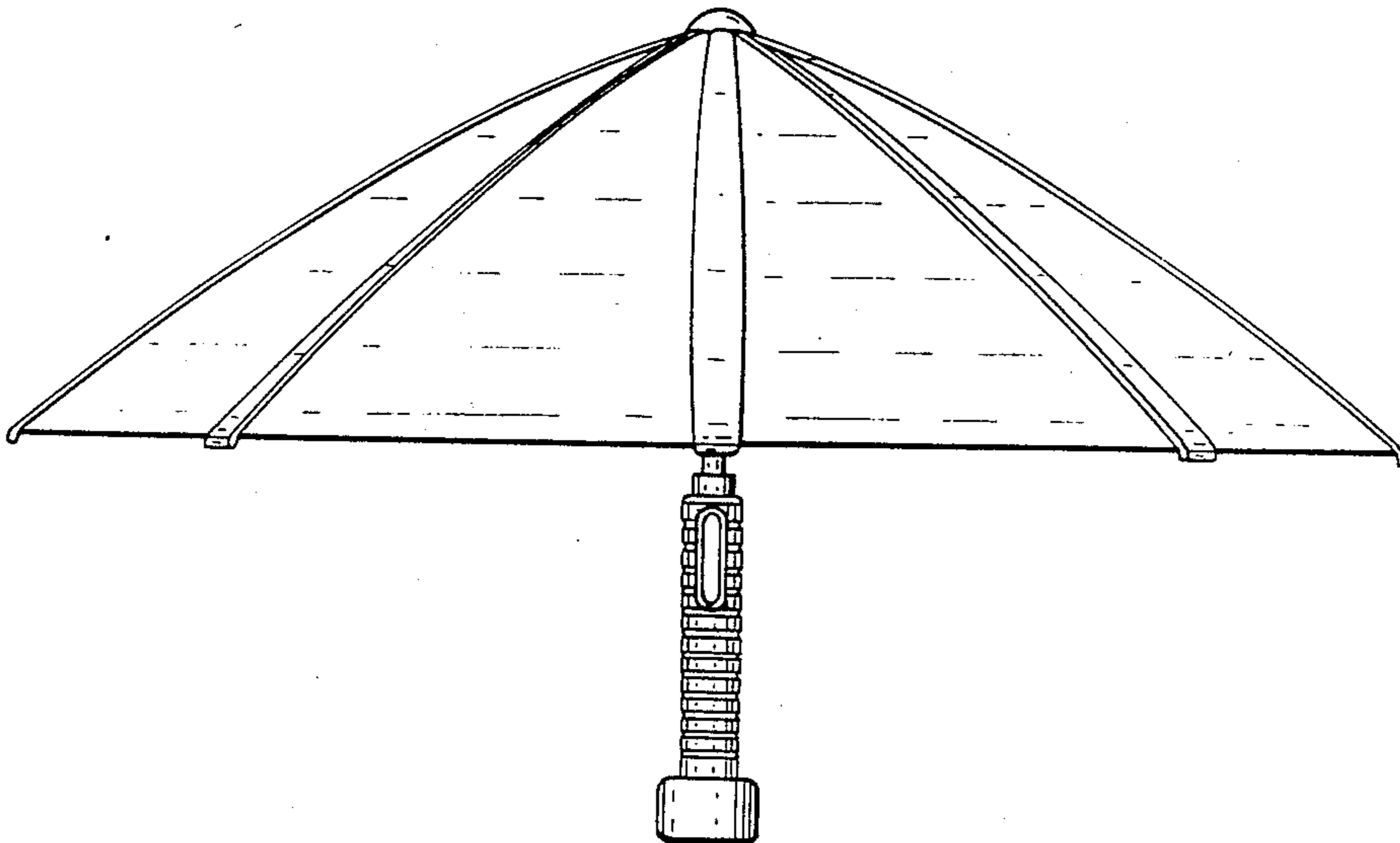

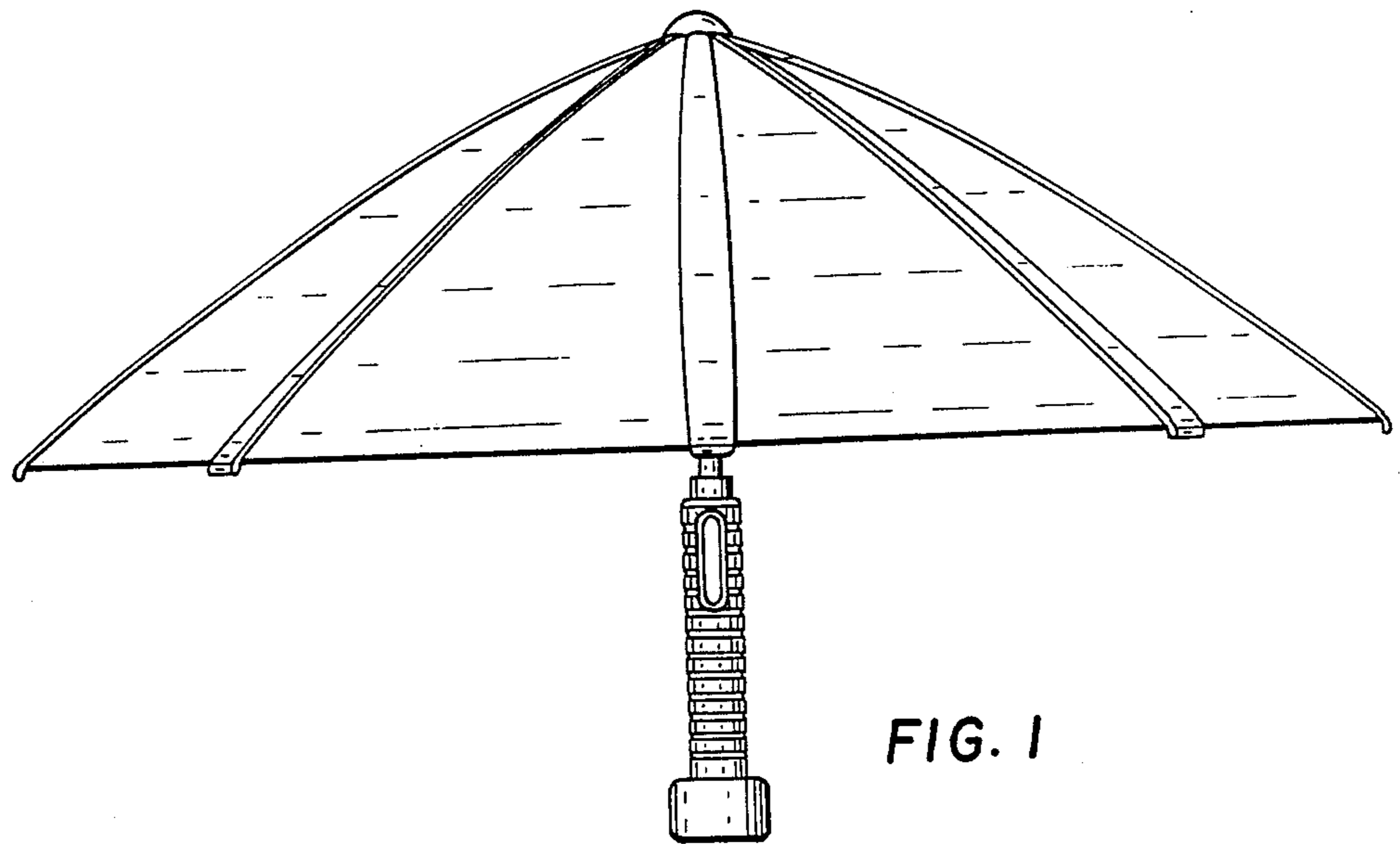

FIG. 1

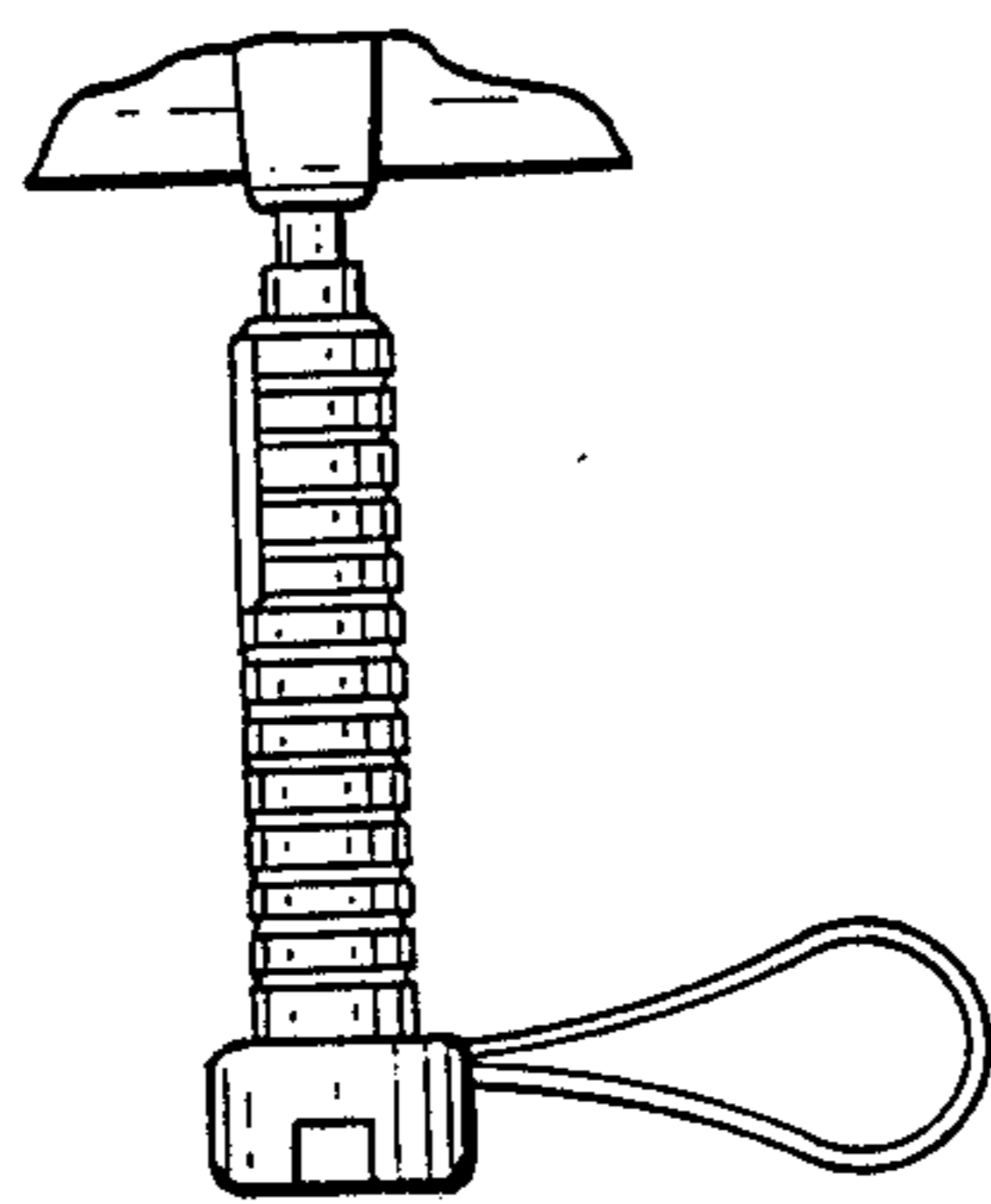

FIG. 2

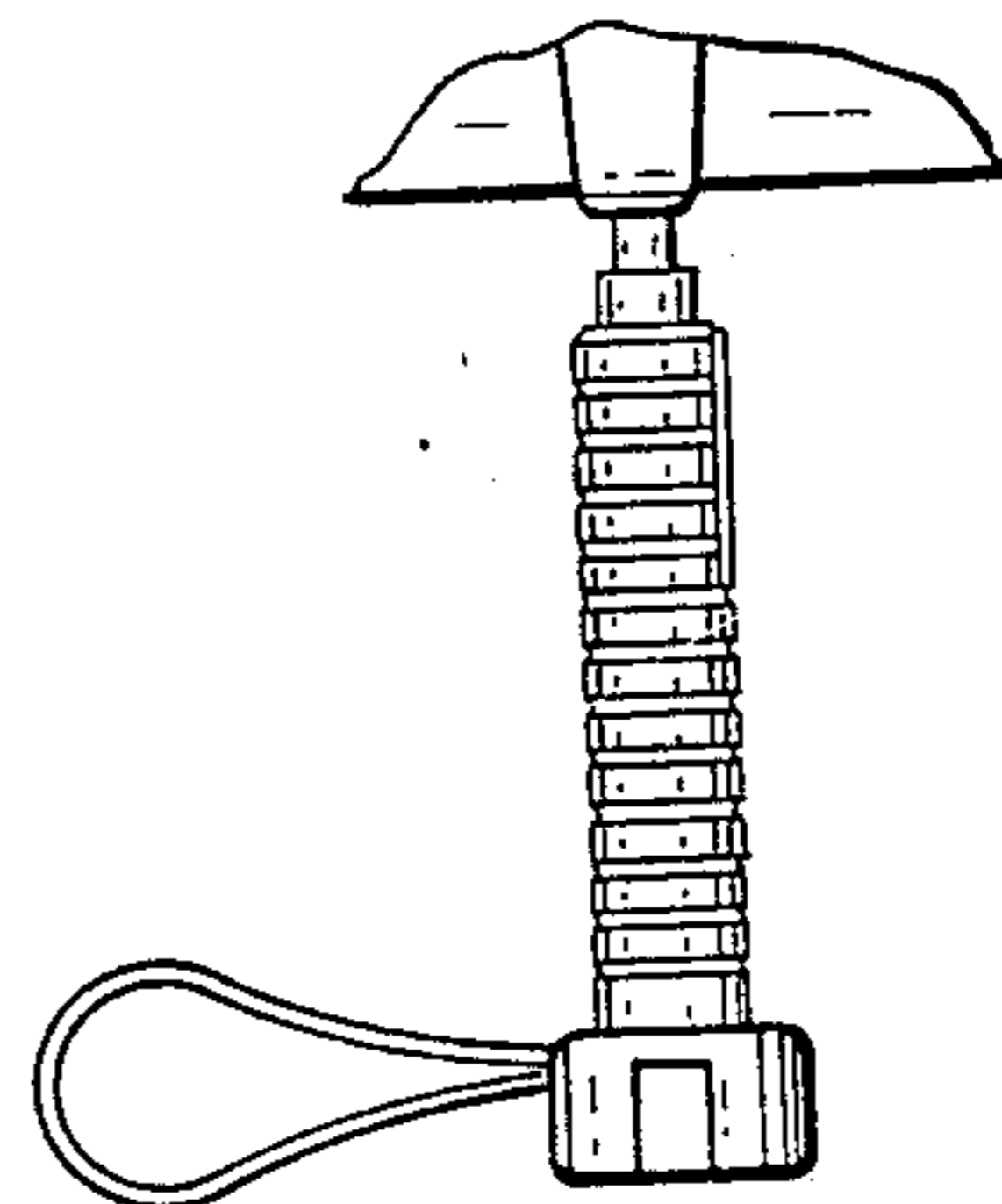

FIG. 3

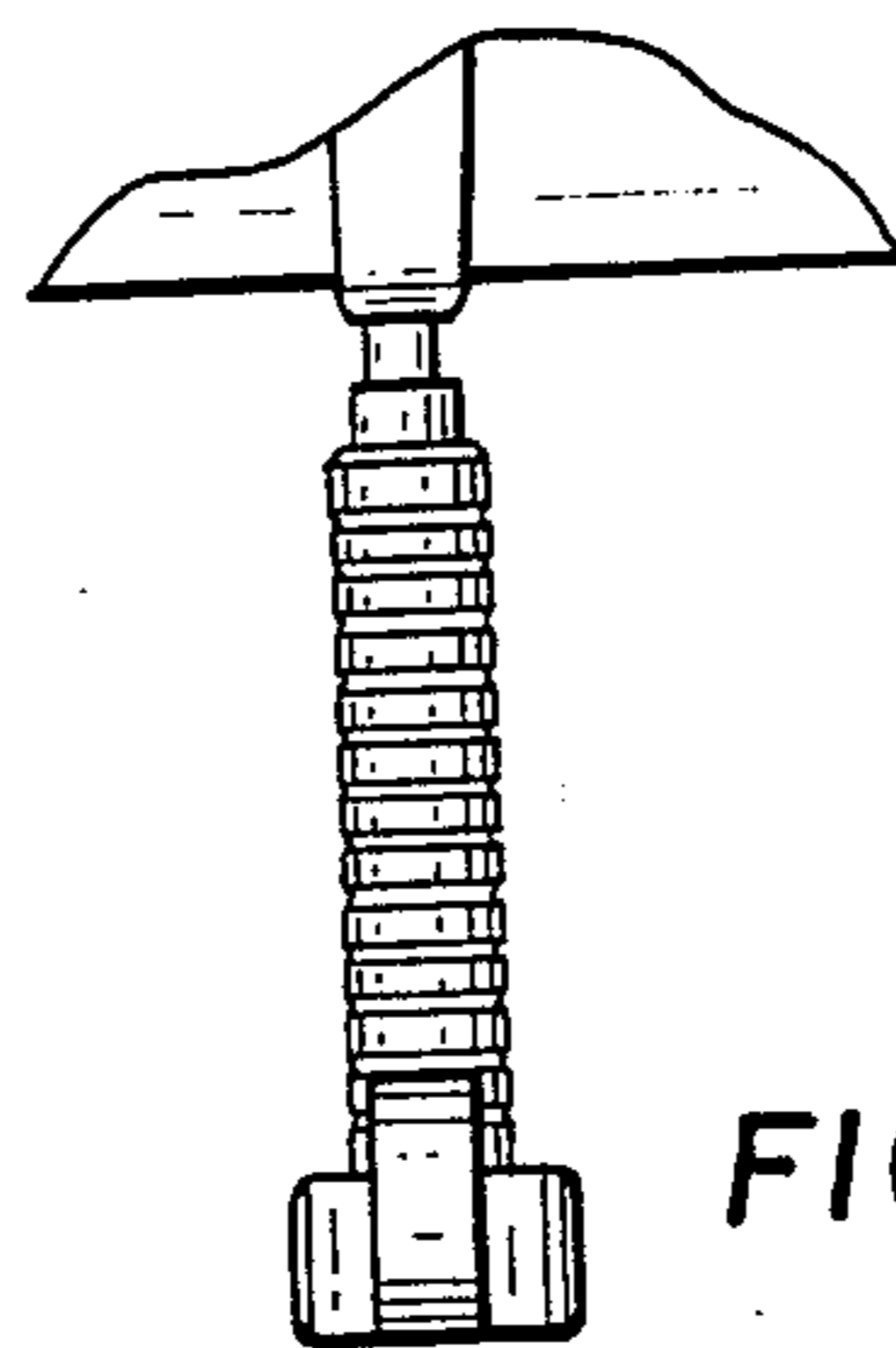

FIG. 4

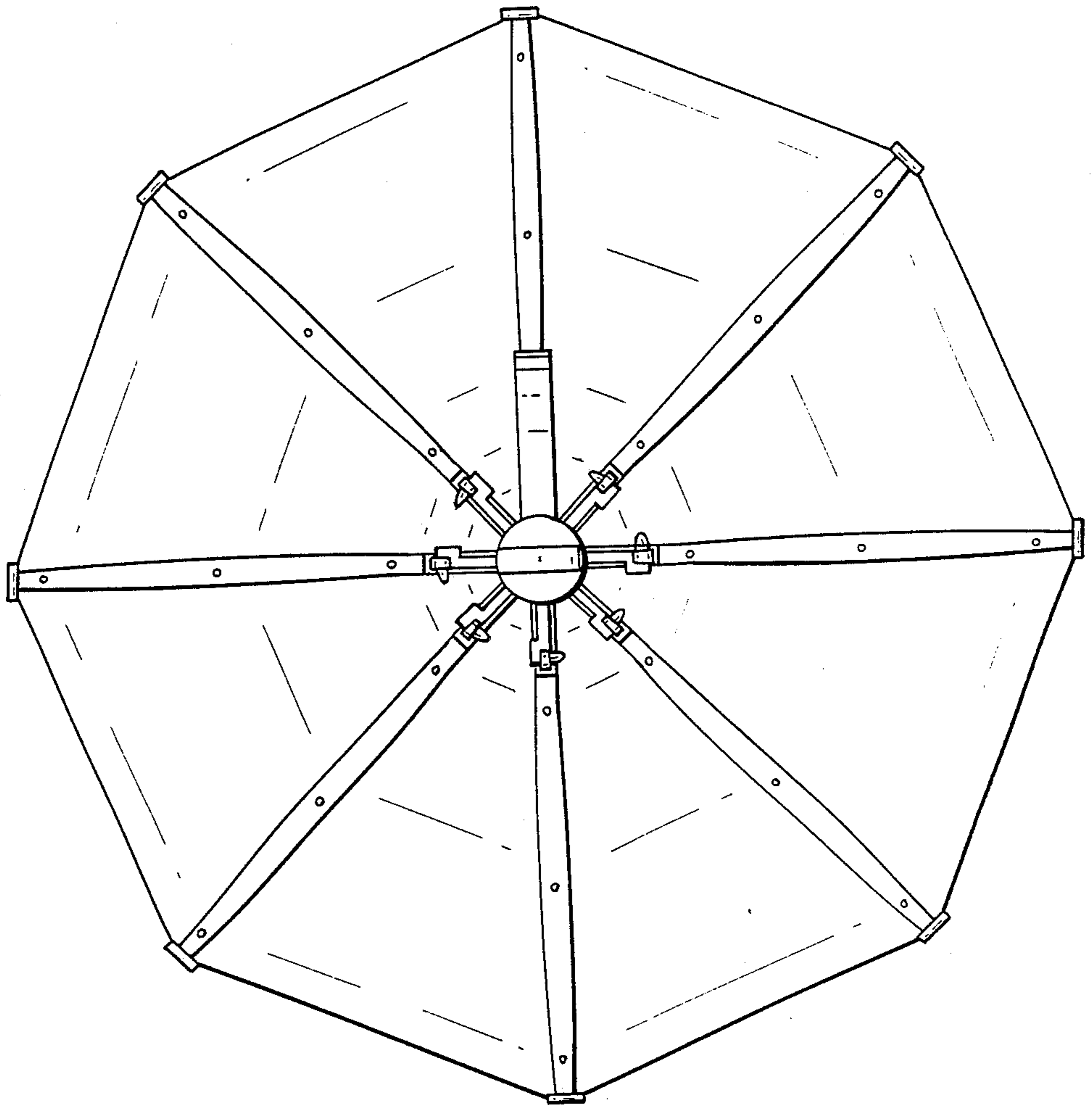

FIG. 5

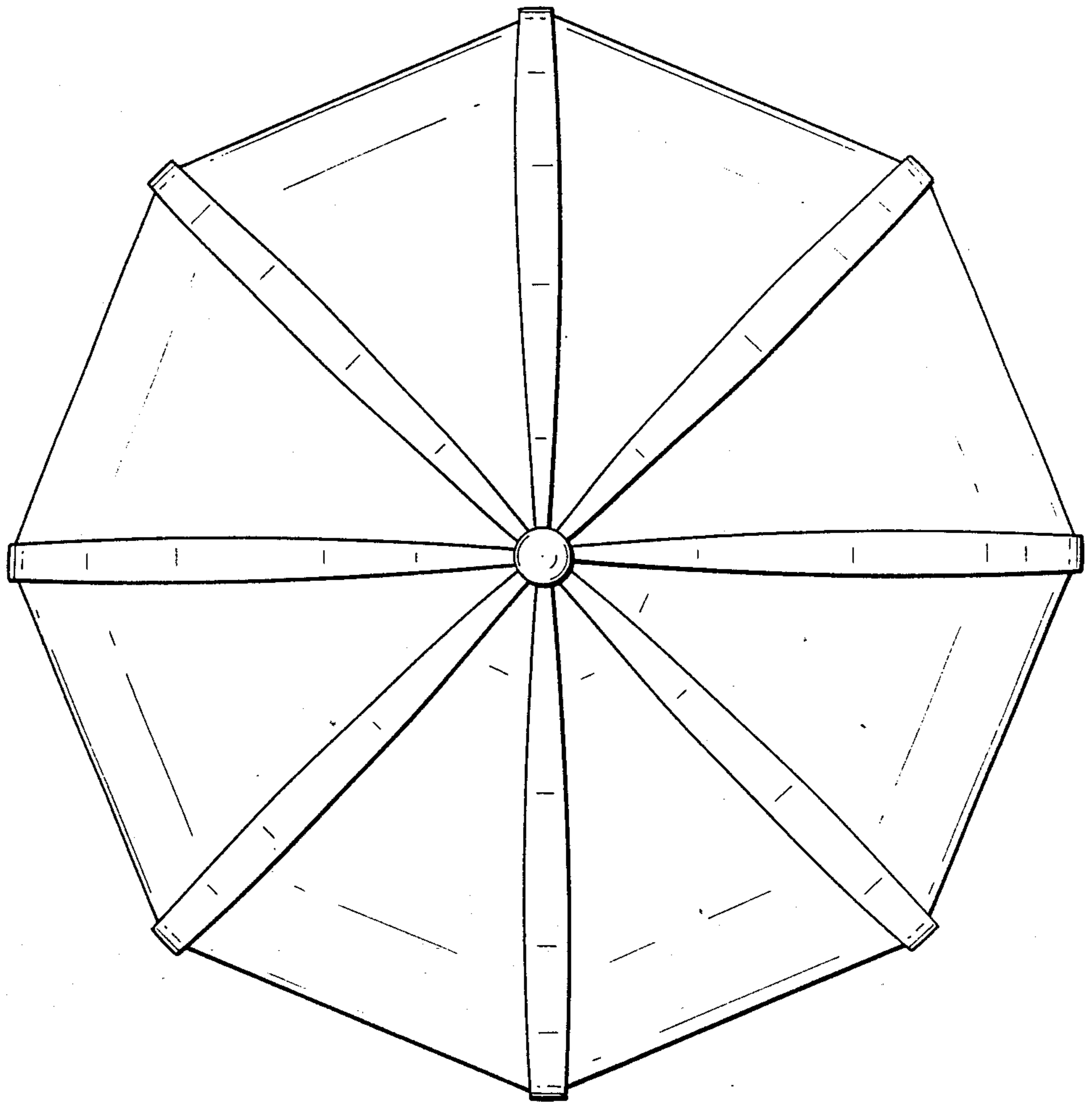

FIG. 6