

# United States Patent [19]

Hara et al.

[11] Patent Number: **Des. 306,018**

[45] Date of Patent: **\*\* Feb. 13, 1990**

[54] **INTREGRAL FACSIMILE AND TELEPHONE**

[75] Inventors: **Kunio Hara**, Chiba; **Shinichi Hiroki**, Tokyo, both of Japan

[73] Assignee: **Kabushiki Kaisha Toshiba**, Kawasaki, Japan

[\*\*] Term: **14 Years**

[21] Appl. No.: **126,679**

[22] Filed: **Nov. 30, 1987**

[30] **Foreign Application Priority Data**

Jun. 2, 1987 [JP] Japan ..... 62-22531

[52] U.S. Cl. .... **D14/118**

[58] Field of Search ..... D14/118, 142, 144, 151;  
D18/36, 37; 358/256, 286

[56] **References Cited**

**U.S. PATENT DOCUMENTS**

D. 295,750 5/1988 Imai ..... D14/118 X

D. 299,494 1/1989 Tsuruoka ..... D14/118

D. 300,139 3/1989 Nishio ..... D14/118

**OTHER PUBLICATIONS**

HFD, 10/5/87, p. 114, top right—Murata F-20.

HFD, 10/19/87, p. 69, Top—Toshiba Personal Facsimile.

Modern Office Technology, Sep. 1987, Advertisement, top left, Ricoh Facsimile.

Modern Office Technology, Nov. 1987, p. 11, bottom left, Ricoh Facsimile.

NEC Catalog of NEFAX-14 received by the assignee company on Feb. 27, 1987.

PANAFAXUF-6 of Matsushita Denso published Aug. 6, 1986.

PANAFAXUF-8 of Matsushita Denso published Jan. 19, 1987.

*Primary Examiner*—Bernard Ansher

*Assistant Examiner*—Theodore M. Shooman

*Attorney, Agent, or Firm*—Oblon, Spivak, McClelland, Maier & Neustadt

[57] **CLAIM**

The ornamental design for a integral facsimile and telephone, as shown and described.

**DESCRIPTION**

FIG. 1 is a top, front and left side perspective view of a integral facsimile and telephone showing our new design;

FIG. 2 is a top plan view thereof;

FIG. 3 is a front elevational view thereof;

FIG. 4 is a rear elevational view thereof;

FIG. 5 is a left side elevational view thereof;

FIG. 6 is a right side elevational view thereof;

FIG. 7 is a bottom plan view thereof; and

FIG. 8 is a top, front and left side perspective view thereof, shown with the telephone separated from the facsimile.

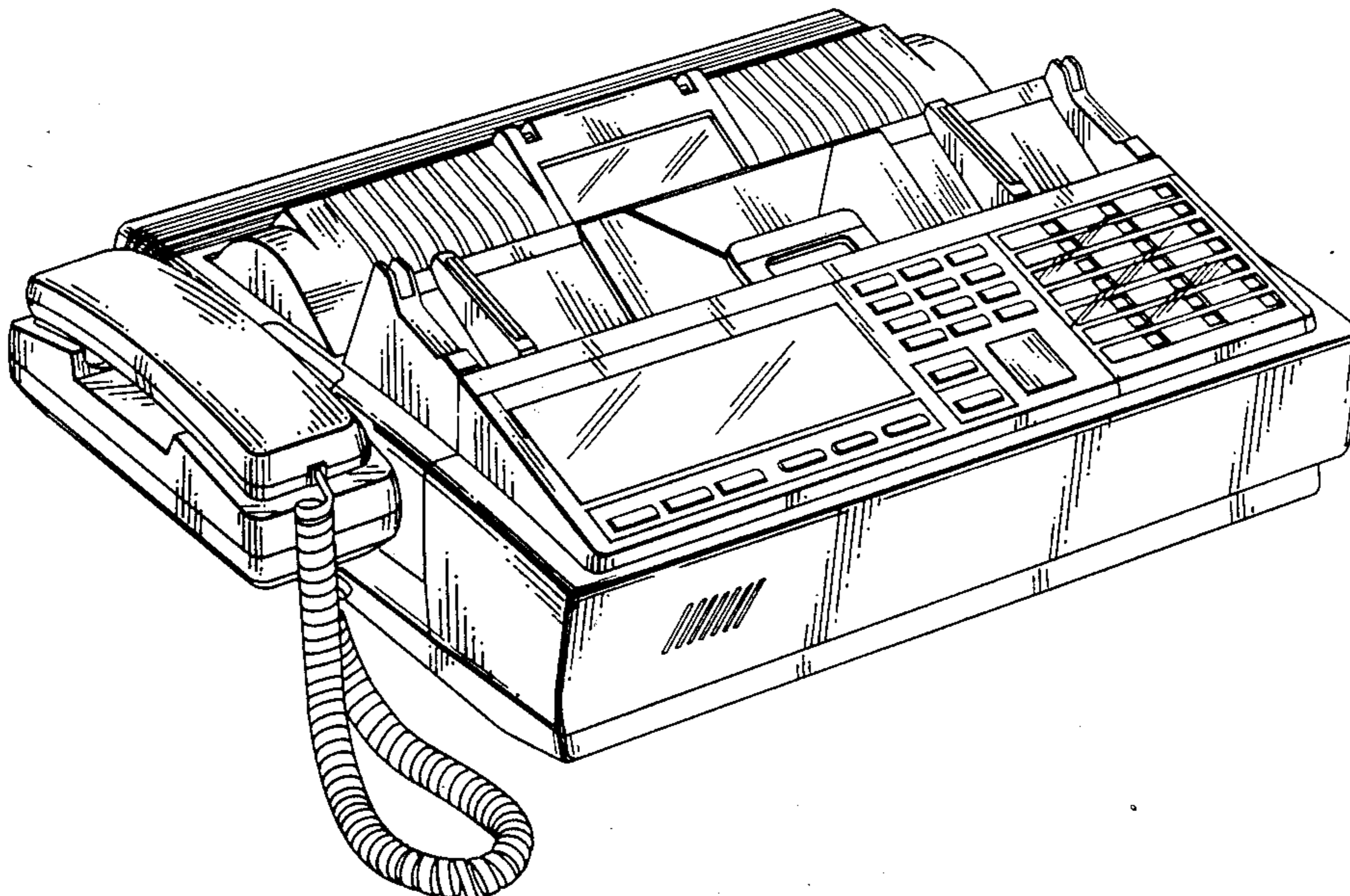

FIG. 1

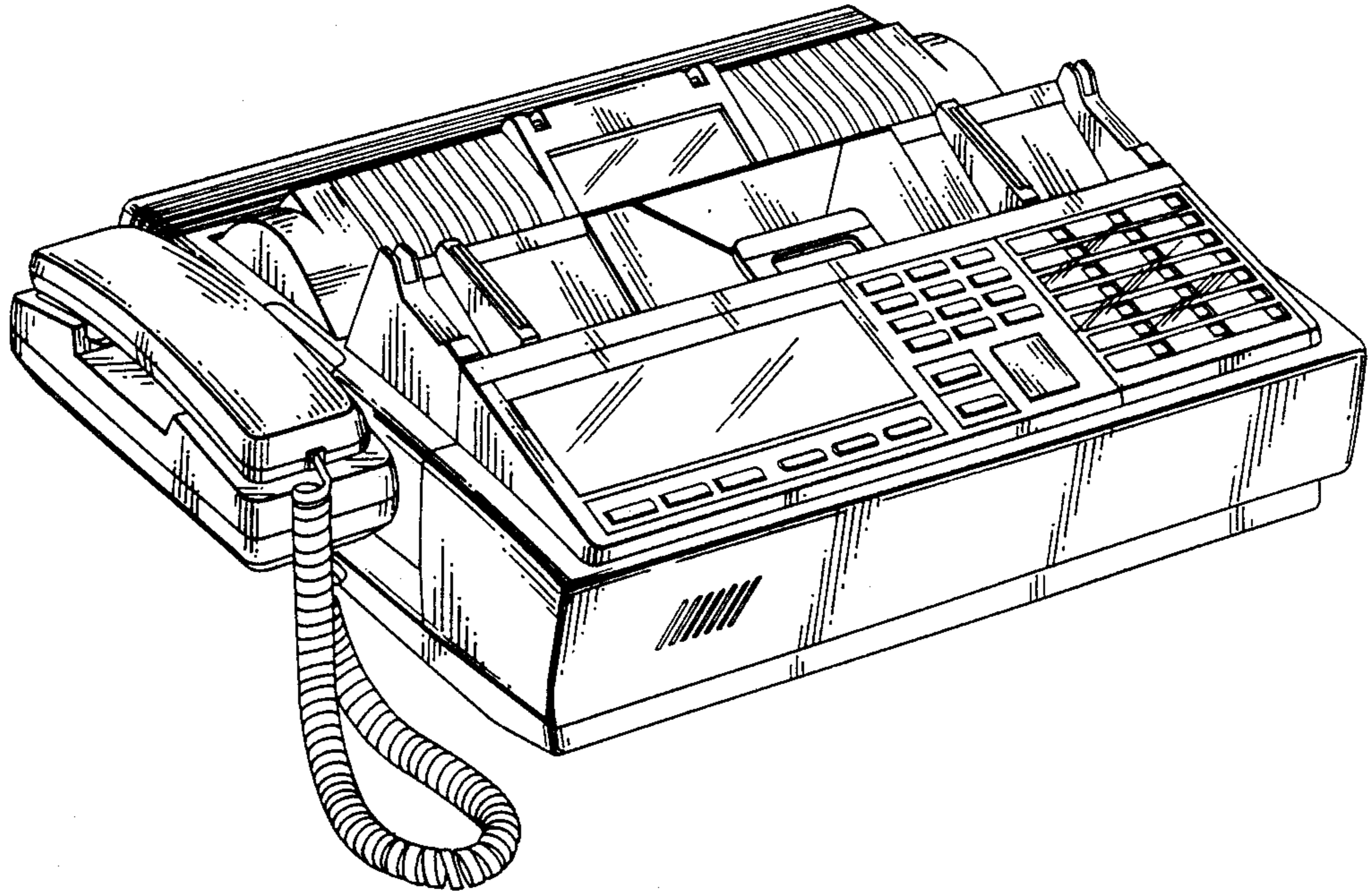

FIG. 2

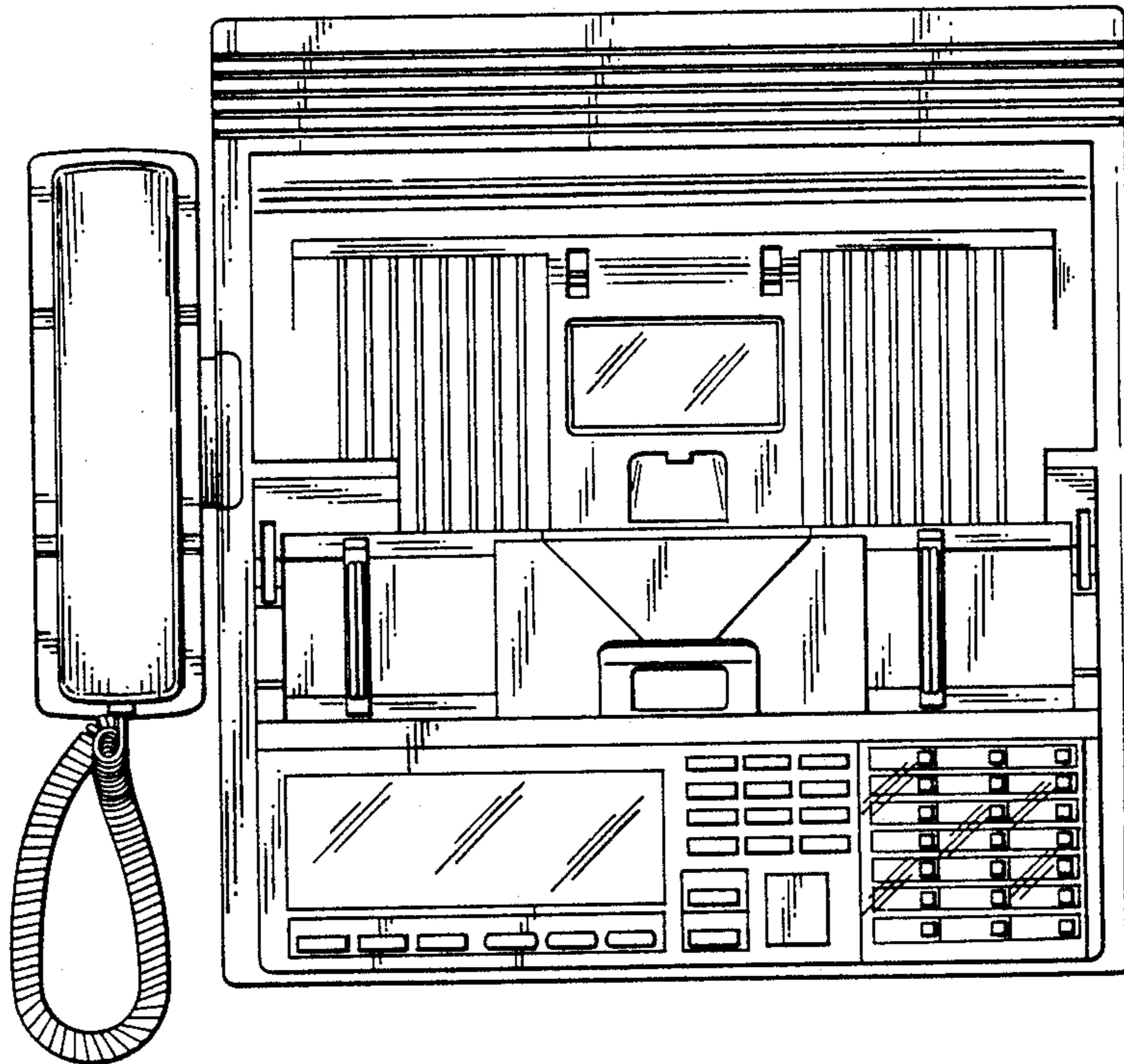



FIG. 3

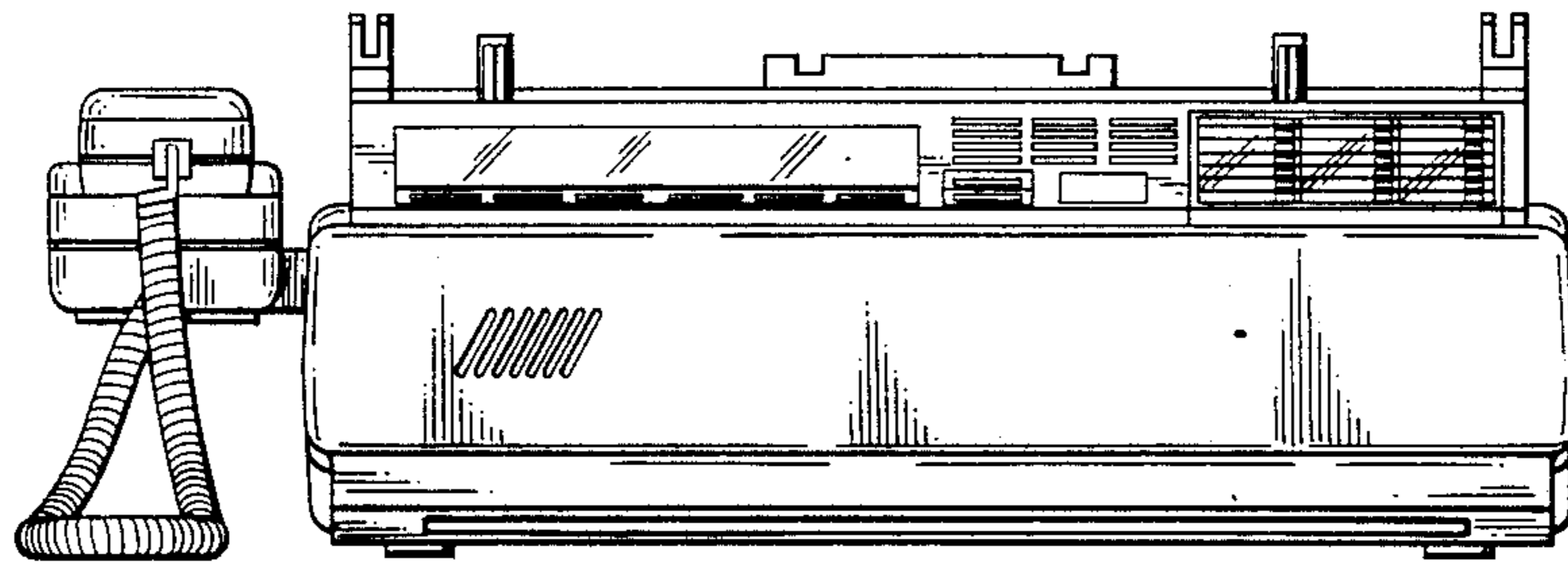

FIG. 4

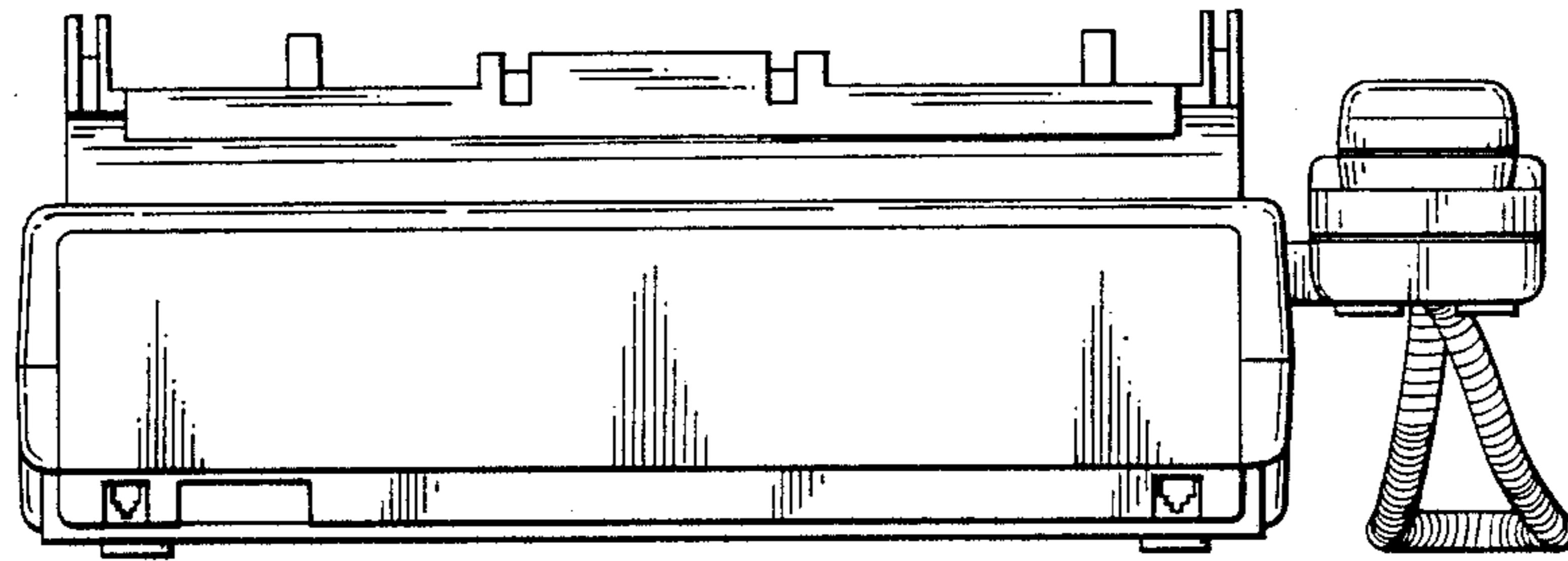

FIG. 5

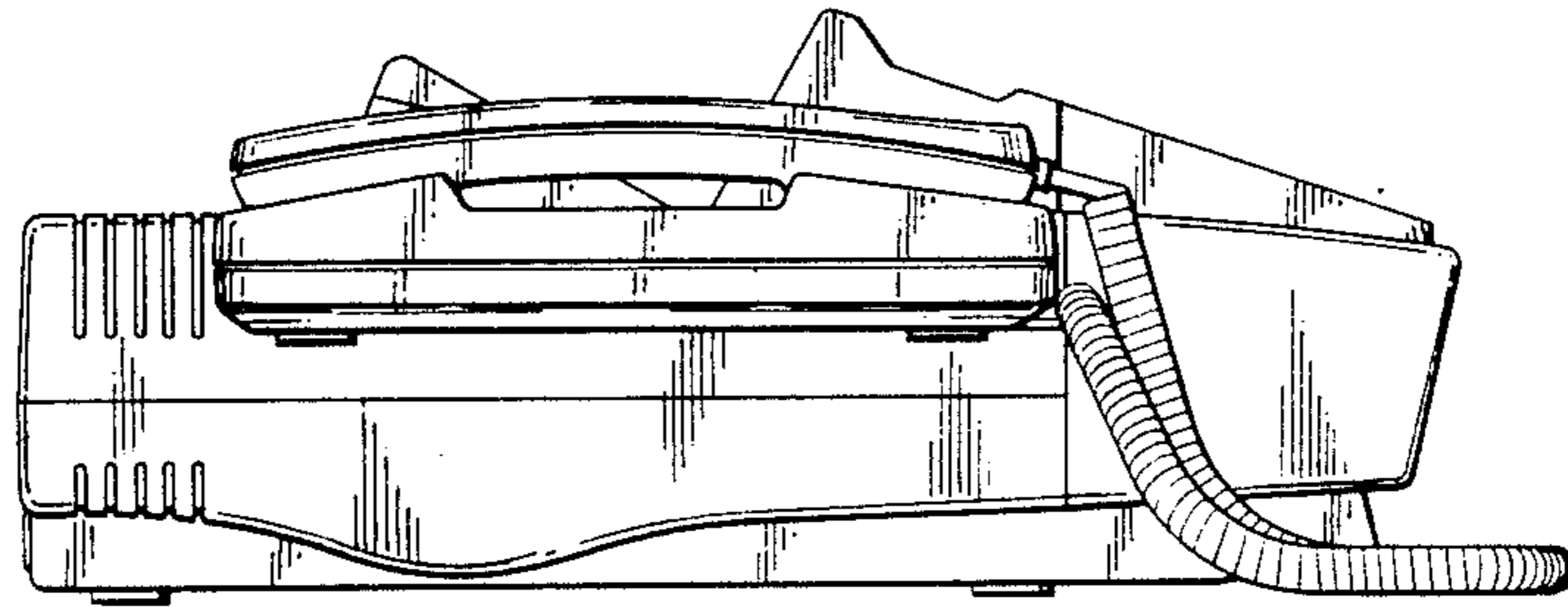

FIG. 6

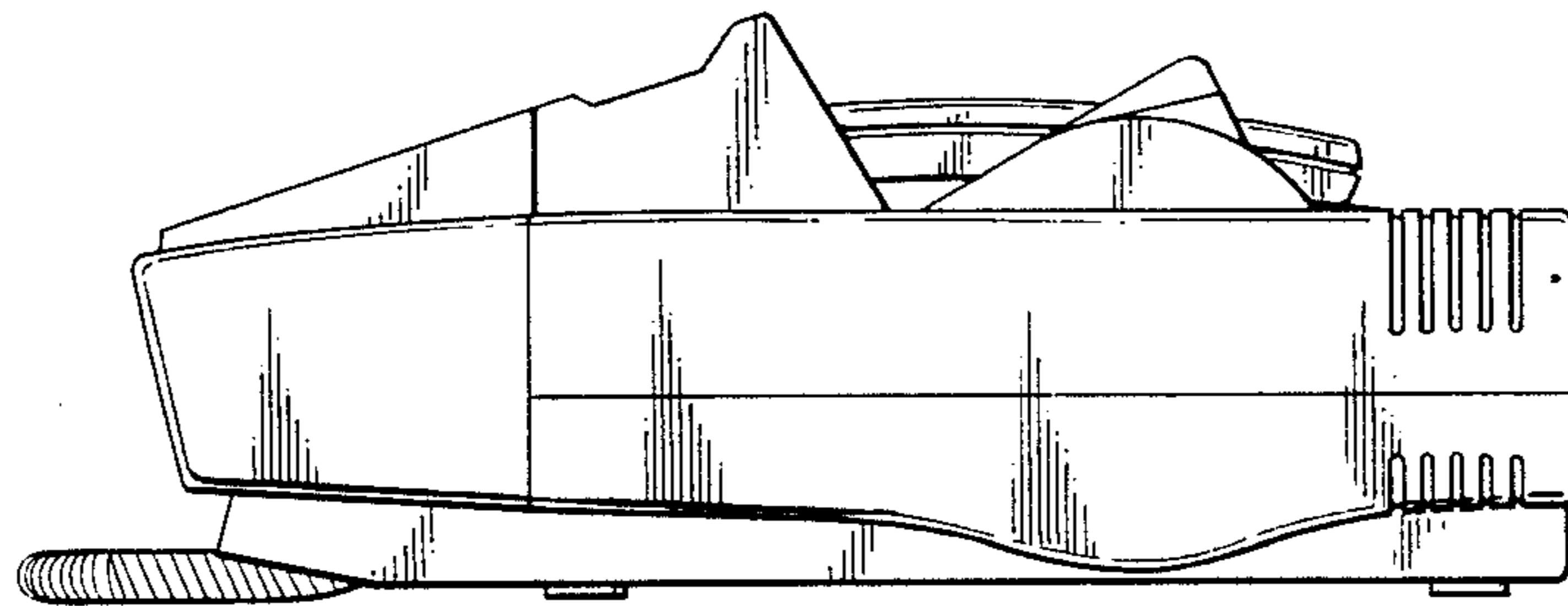

FIG. 7

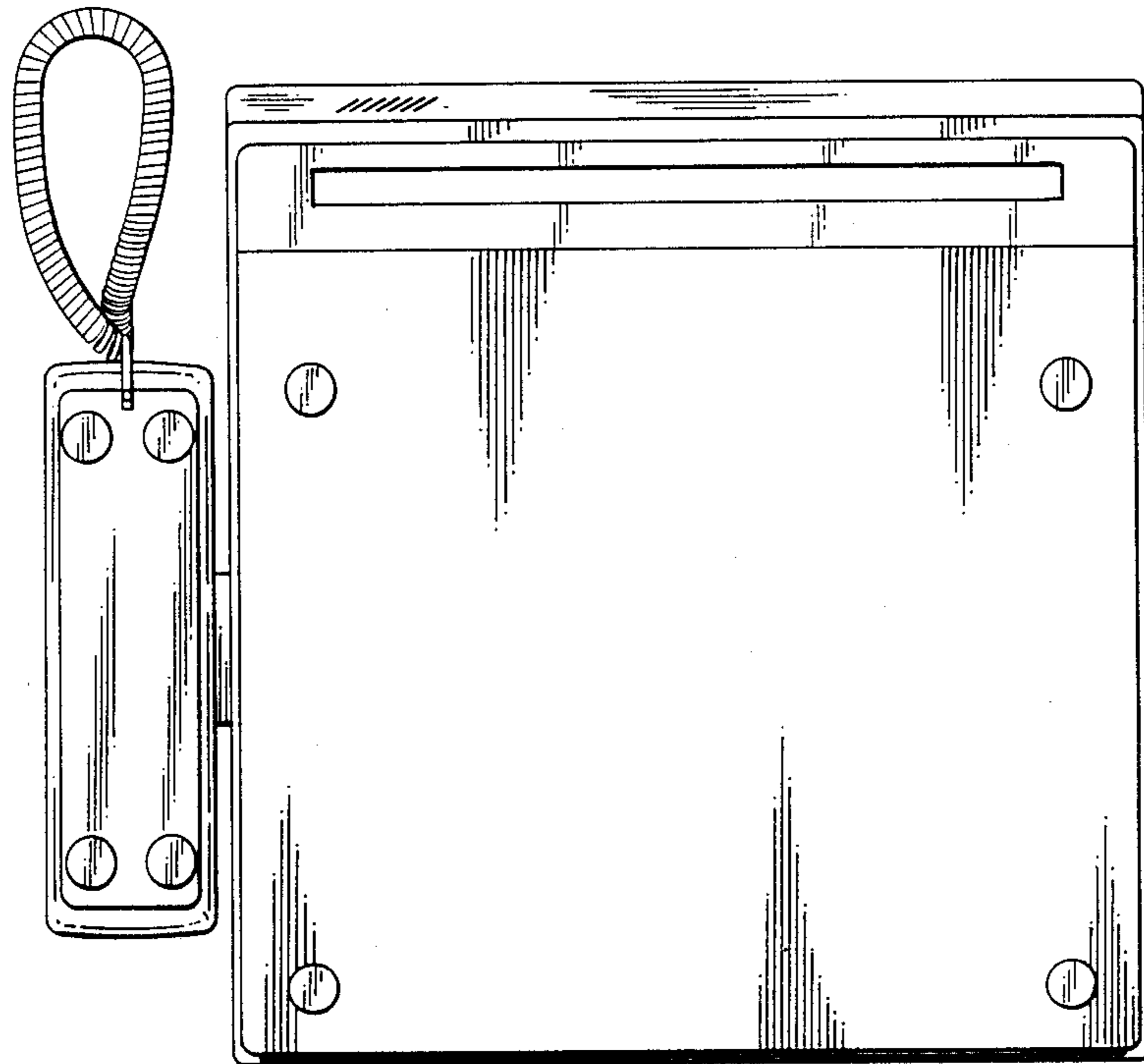

FIG. 8

