

[54] **DRINKING STRAW DISPENSING CONTAINER**

[56] **References Cited**

**U.S. PATENT DOCUMENTS**

D. 187,198 2/1960 Robinson ..... D7/75

[75] **Inventors: Ellen M. Marqua; John T. Marqua,**  
both of Rockford, Ill.

*Primary Examiner*—Bernard Ansher  
*Assistant Examiner*—Terry A. Pfeffer  
*Attorney, Agent, or Firm*—Leydig, Voit & Mayer, Ltd.

[73] **Assignee: Expressions in Wood, Inc., Rockford,**  
Ill.

[57] **CLAIM**

The ornamental design for a drinking straw dispensing container, as shown and described.

[\*\*] **Term: 14 Years**

**DESCRIPTION**

[21] **Appl. No.: 37,576**

FIG. 1 is a front perspective view of a drinking straw dispensing container showing our new design.

[22] **Filed: Apr. 13, 1987**

FIG. 2 is a rear perspective view thereof.

[52] **U.S. Cl. .... D7/635**

FIG. 3 is a side elevational view thereof.

[58] **Field of Search ..... D7/75, 72; D6/515, 517;**  
221/191-194, 59, 279; 211/51, 59.3; 312/42, 45,  
72-73; 206/443; 217/64

FIG. 4 is a front elevational view thereof.

FIG. 5 is a top plan view thereof.

FIG. 6 is a rear elevational view thereof.

FIG. 7 is a bottom plan view thereof.

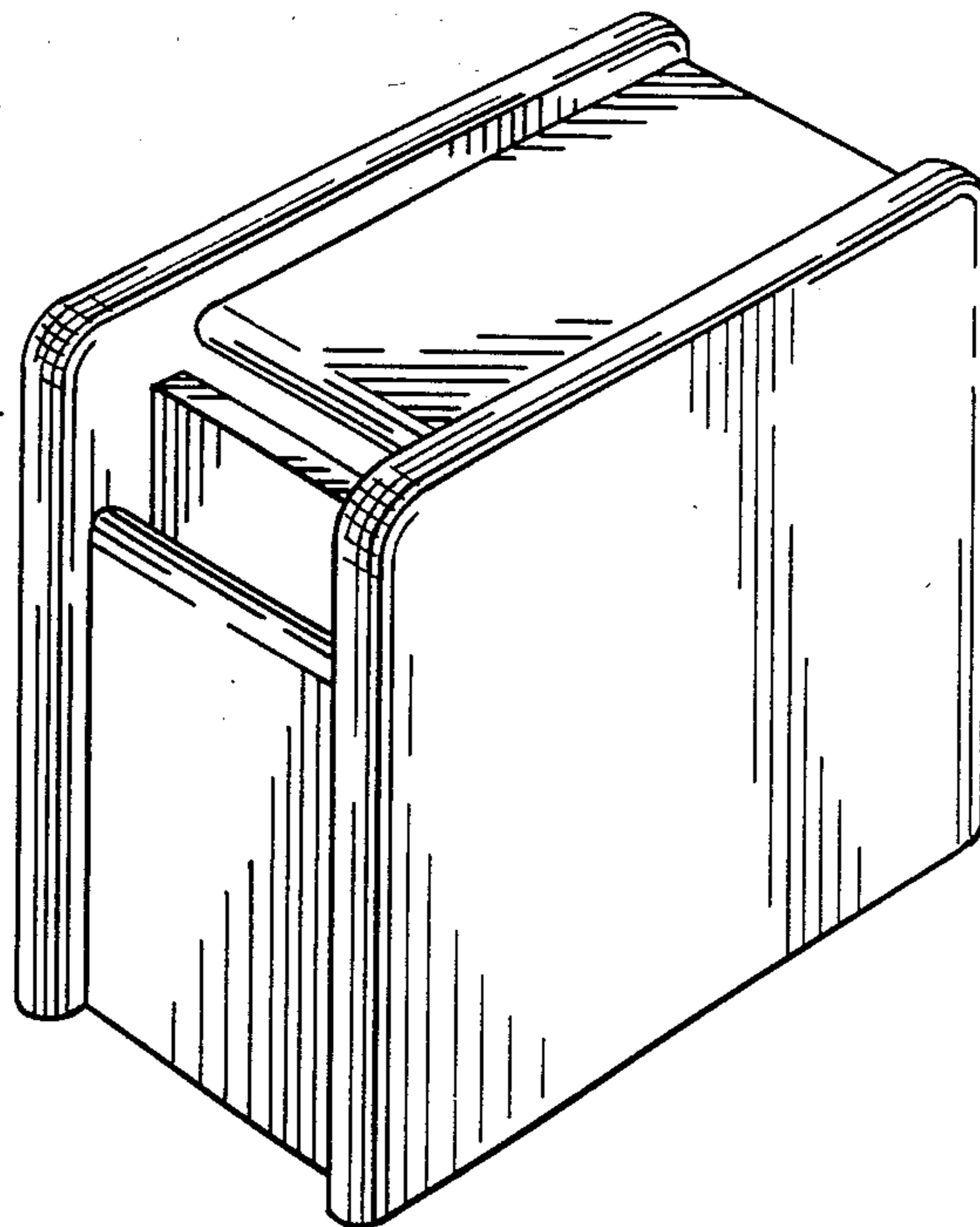

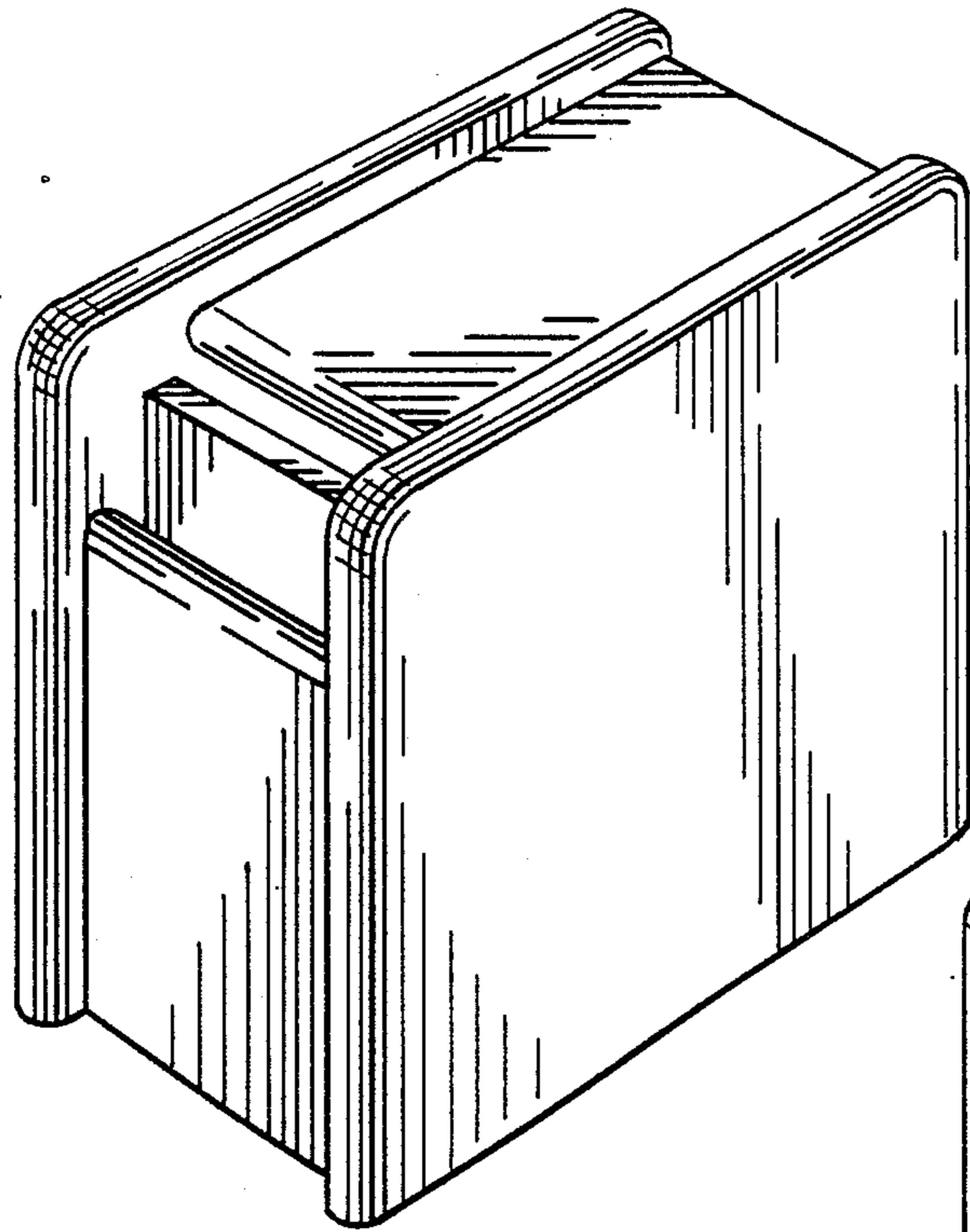

FIG. 1.

FIG. 2.

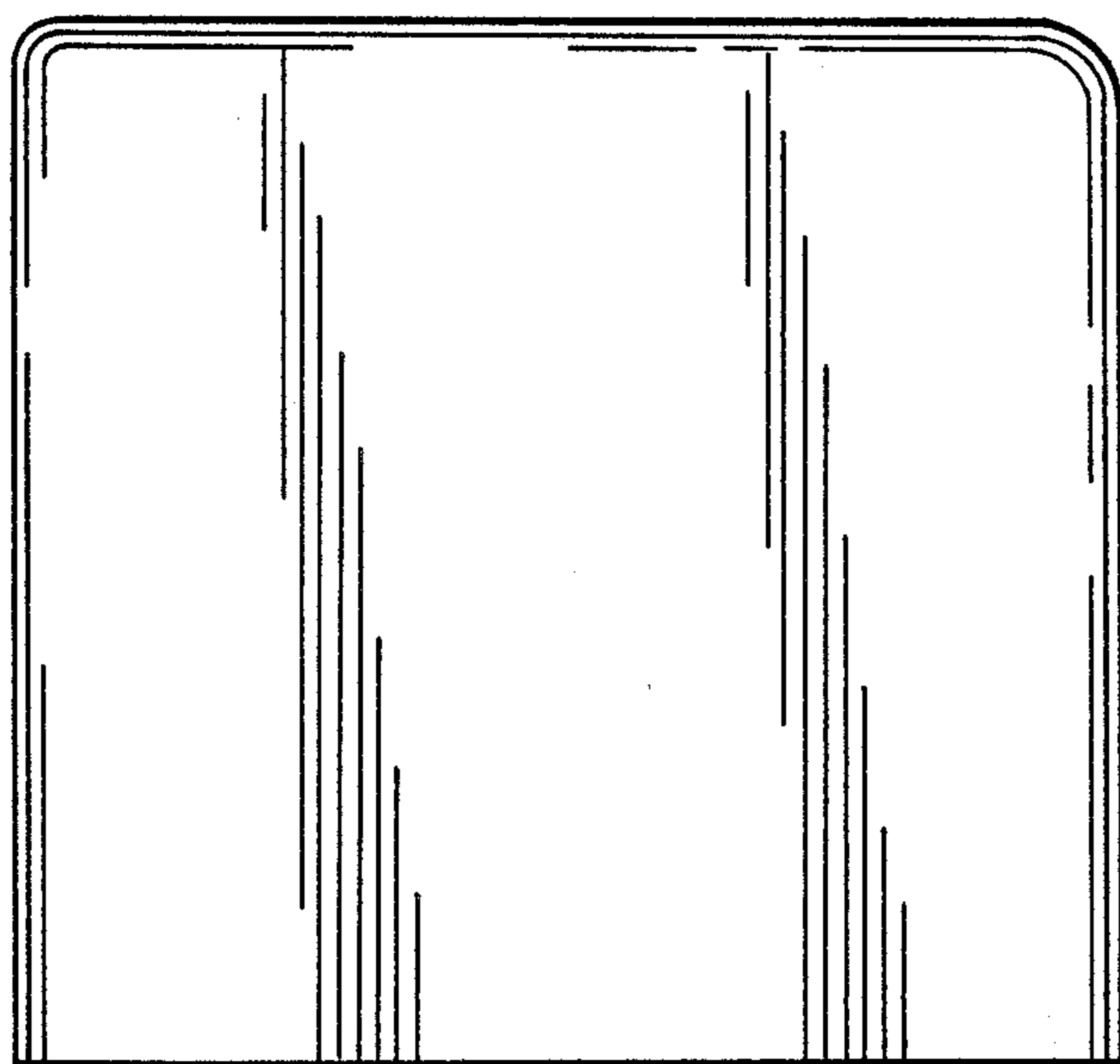
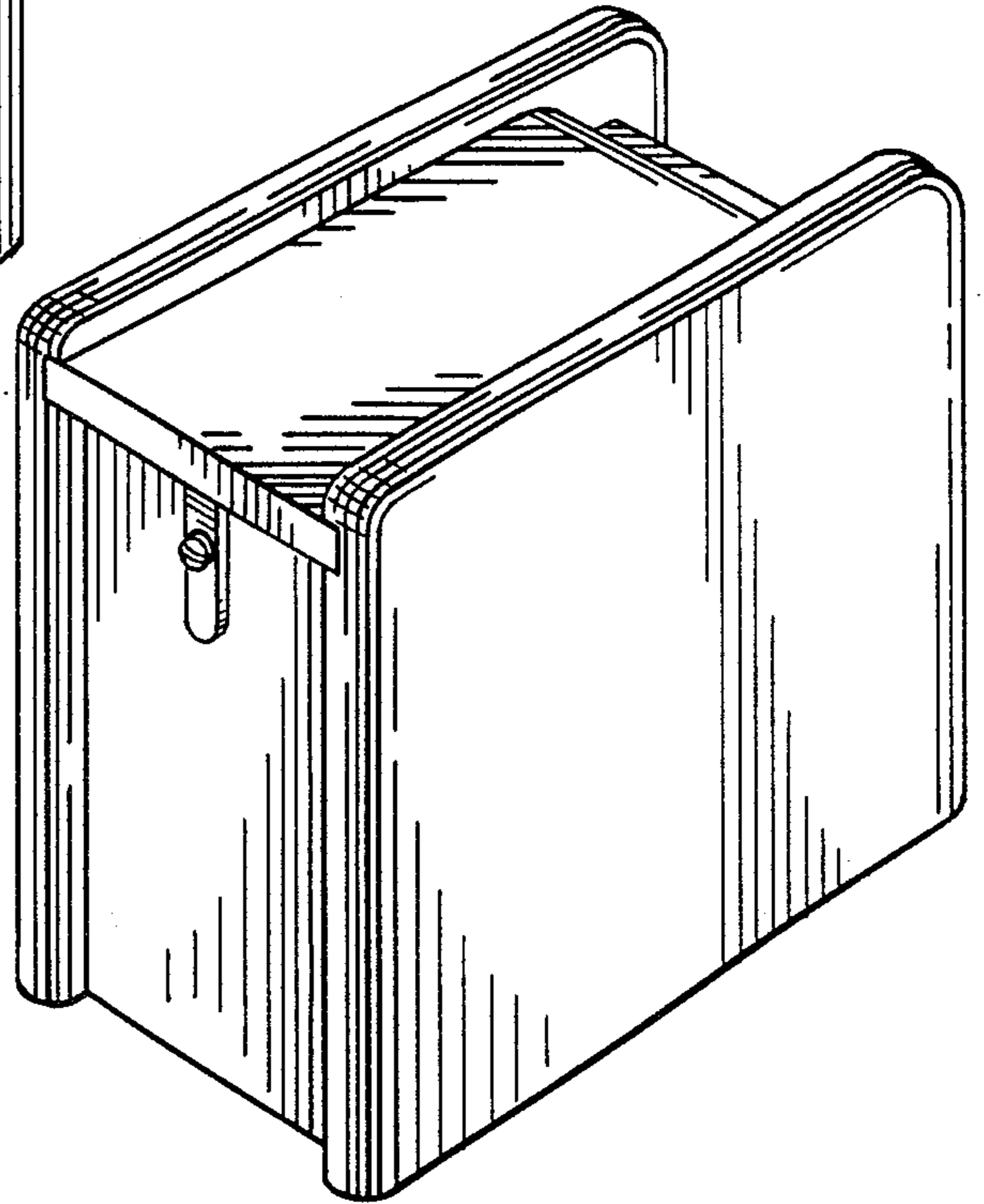

FIG. 3.

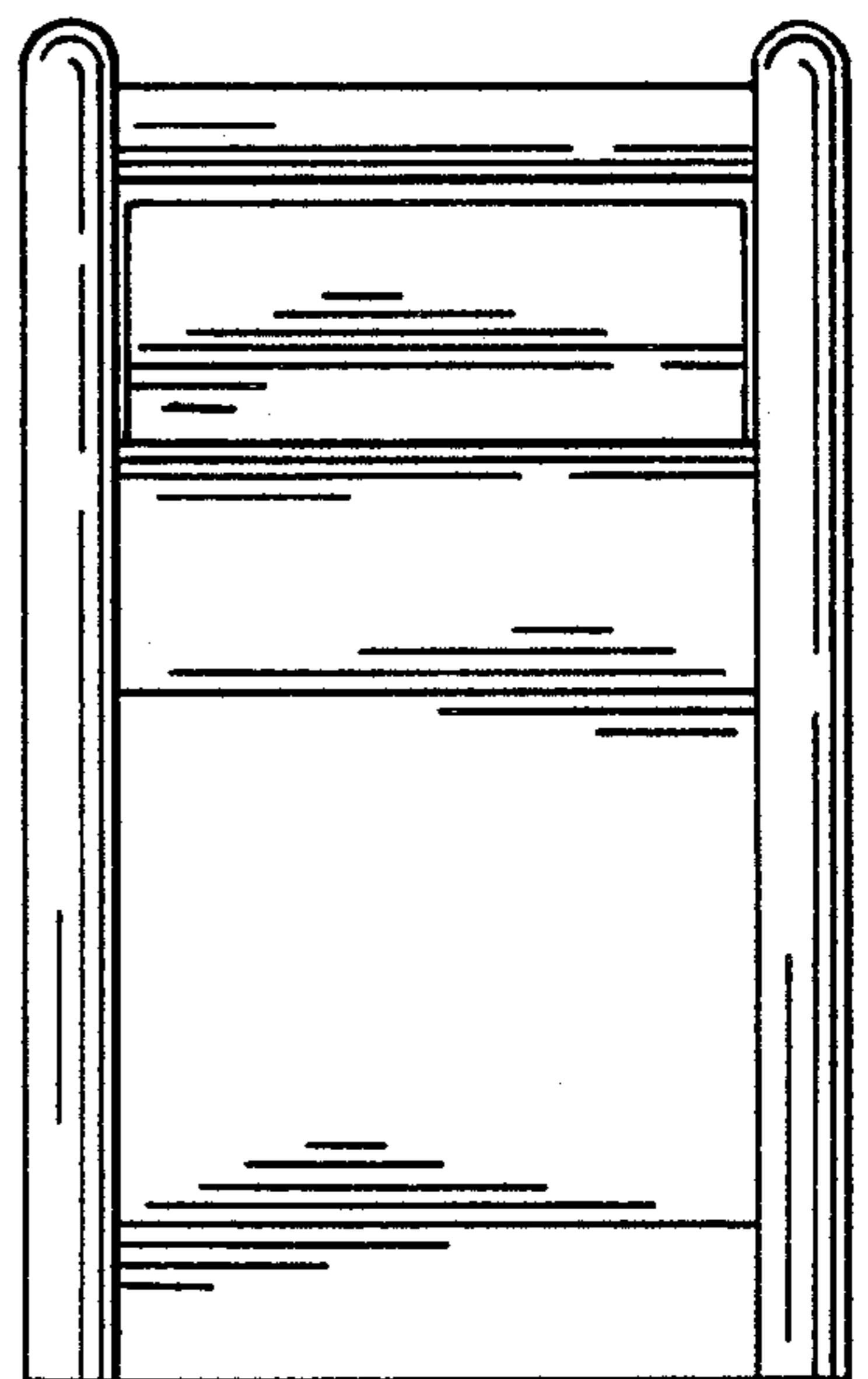

FIG. 4.

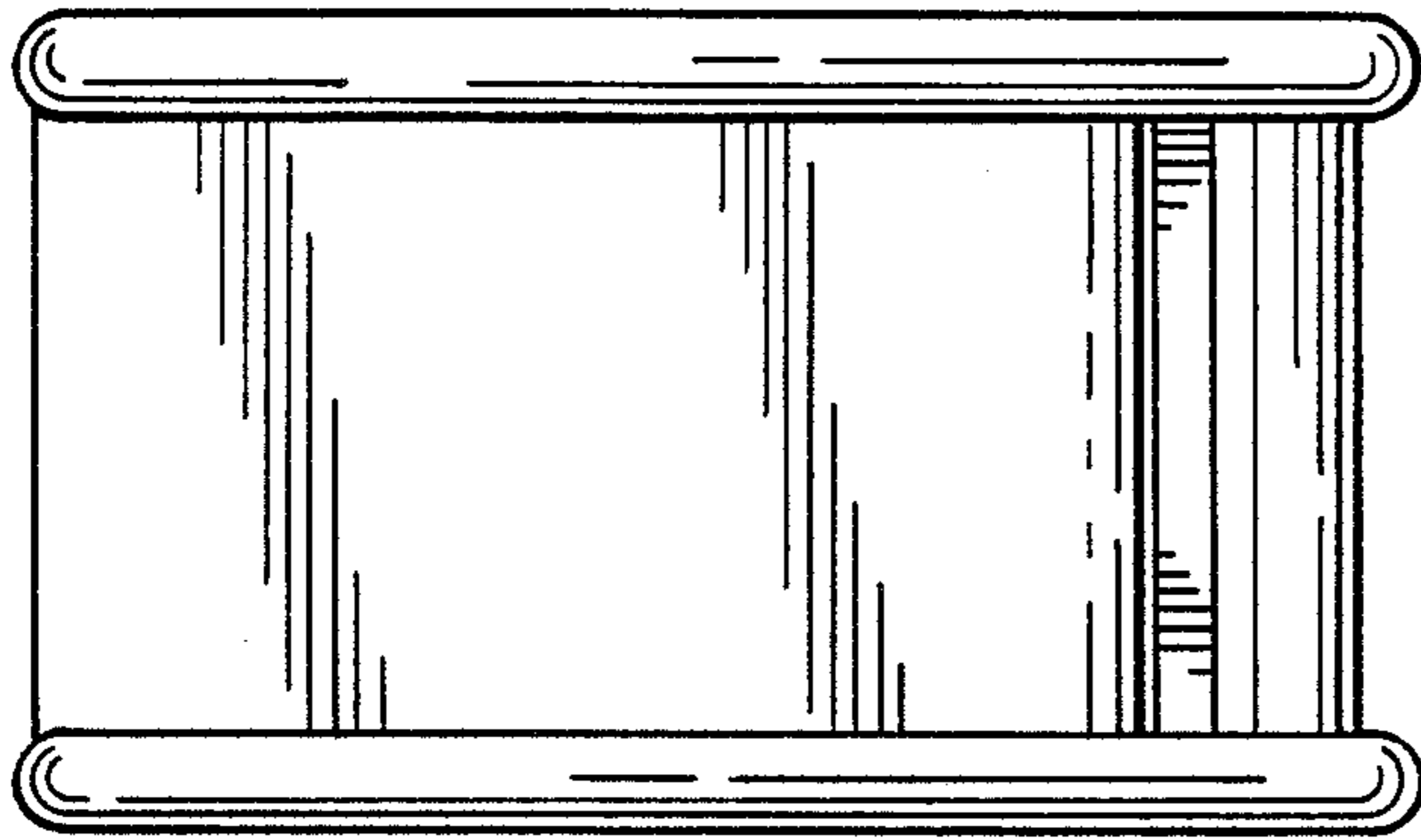

FIG. 5.

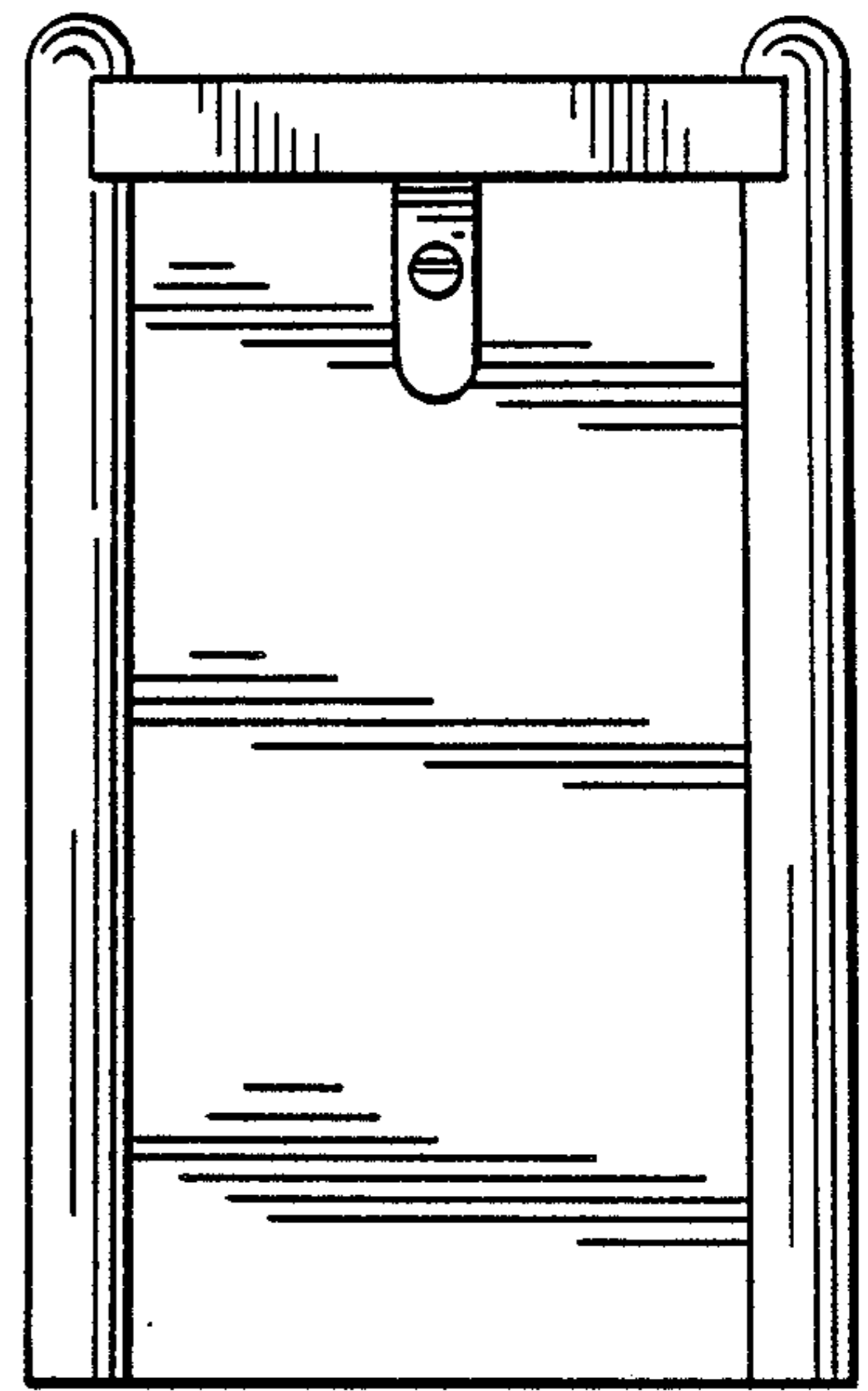

FIG. 6.

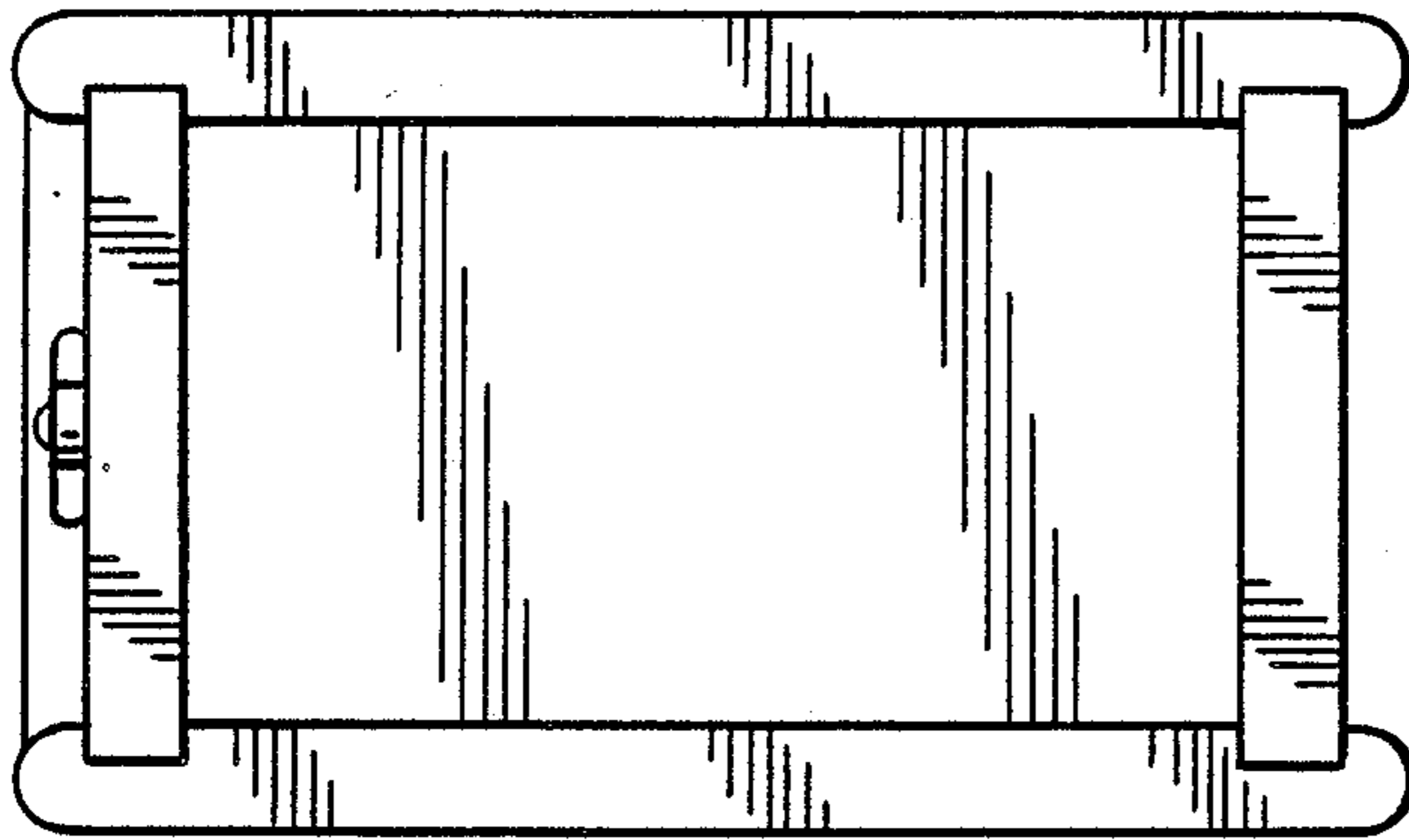

FIG. 7.