

[54] **PRINTER**

[75] **Inventor: Takashi Yomo, Yokohama, Japan**

[73] **Assignee: Canon Kabushiki Kaisha, Tokyo, Japan**

[**] **Term: 14 Years**

[21] **Appl. No.: 29,874**

[22] **Filed: Mar. 25, 1987**

[30] **Foreign Application Priority Data**

Oct. 3, 1986 [JP] Japan 61-39384

[52] **U.S. Cl. D18/13**

[58] **Field of Search D18/13; D14/111;
364/900**

[56] **References Cited**

U.S. PATENT DOCUMENTS

- D. 246,974 1/1978 Thorwallsen et al. D14/111
- D. 250,144 10/1978 Coppola D18/13
- D. 251,492 4/1979 Kneale et al. D18/13 X
- D. 270,732 9/1983 Brown et al. D18/13 X
- D. 272,741 2/1984 Mailer et al. D14/111
- D. 275,677 9/1984 Suzuki et al. D18/13 X
- D. 279,783 7/1985 Jordan et al. D14/111

- D. 280,723 9/1985 Nishida et al. D14/111
- D. 283,900 5/1986 Hollerith, Jr. et al. D14/111 X
- D. 285,567 9/1986 Kenji et al. D14/111
- D. 287,497 12/1986 Goodner et al. D14/111
- D. 287,730 1/1987 Kojima et al. D14/111

Primary Examiner—James R. Largen
Attorney, Agent, or Firm—Fitzpatrick, Cella, Harper & Scinto

[57] **CLAIM**

The ornamental design for a printer, as shown and described.

DESCRIPTION

FIG. 1 is a front elevational view of a printer showing my new design;

FIG. 2 is a rear elevational view thereof;

FIG. 3 is a top plan view thereof;

FIG. 4 is a bottom plan view thereof;

FIG. 5 is a left side elevational view thereof;

FIG. 6 is a right side elevational view thereof; and

FIG. 7 is a perspective view taken from the top, front and right side thereof.

The broken line representation of a paper supply cassette and a paper discharge tray in FIG. 7 are for purposes of illustration only and form no part of the claimed design.

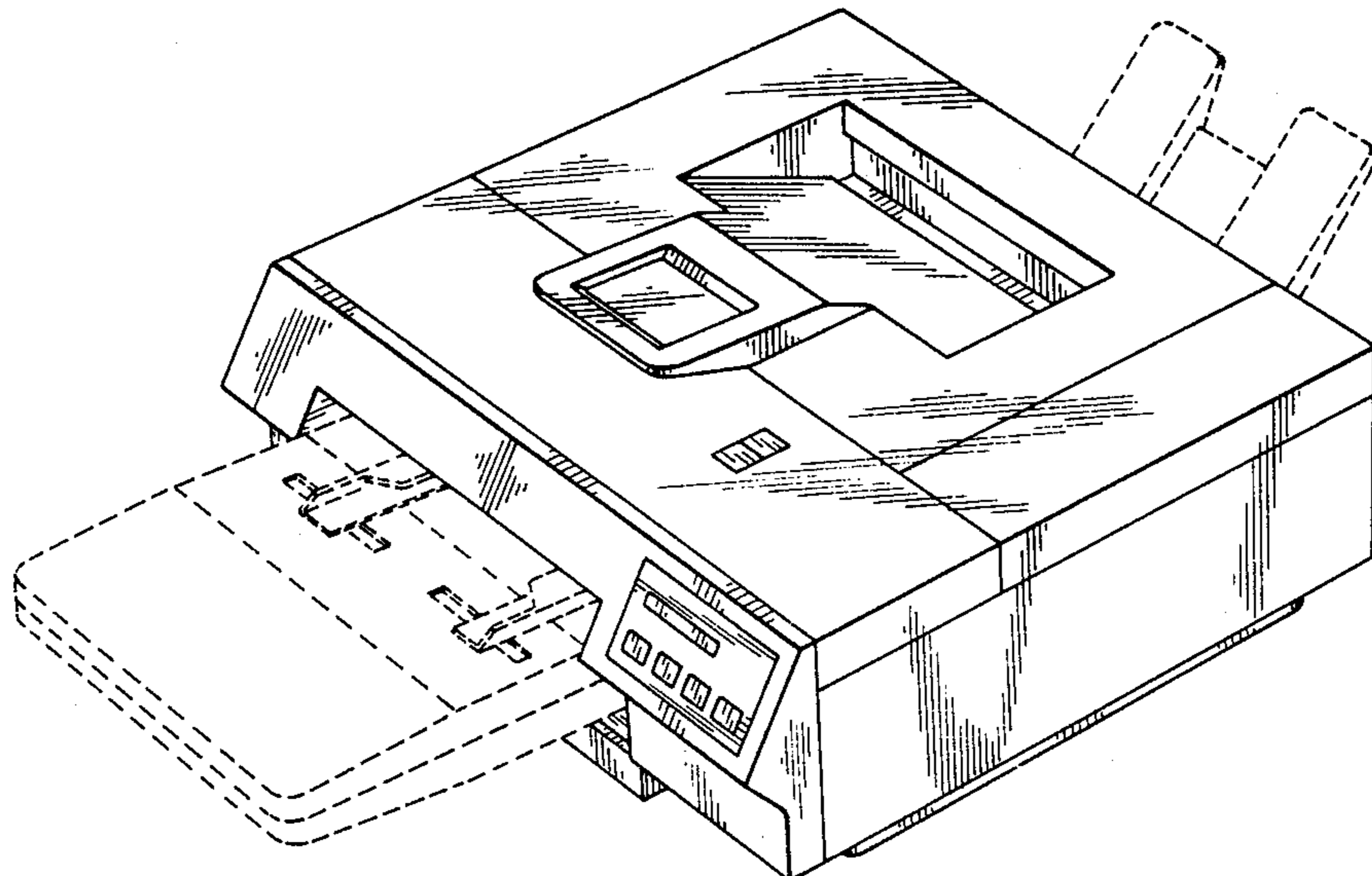

FIG. 1

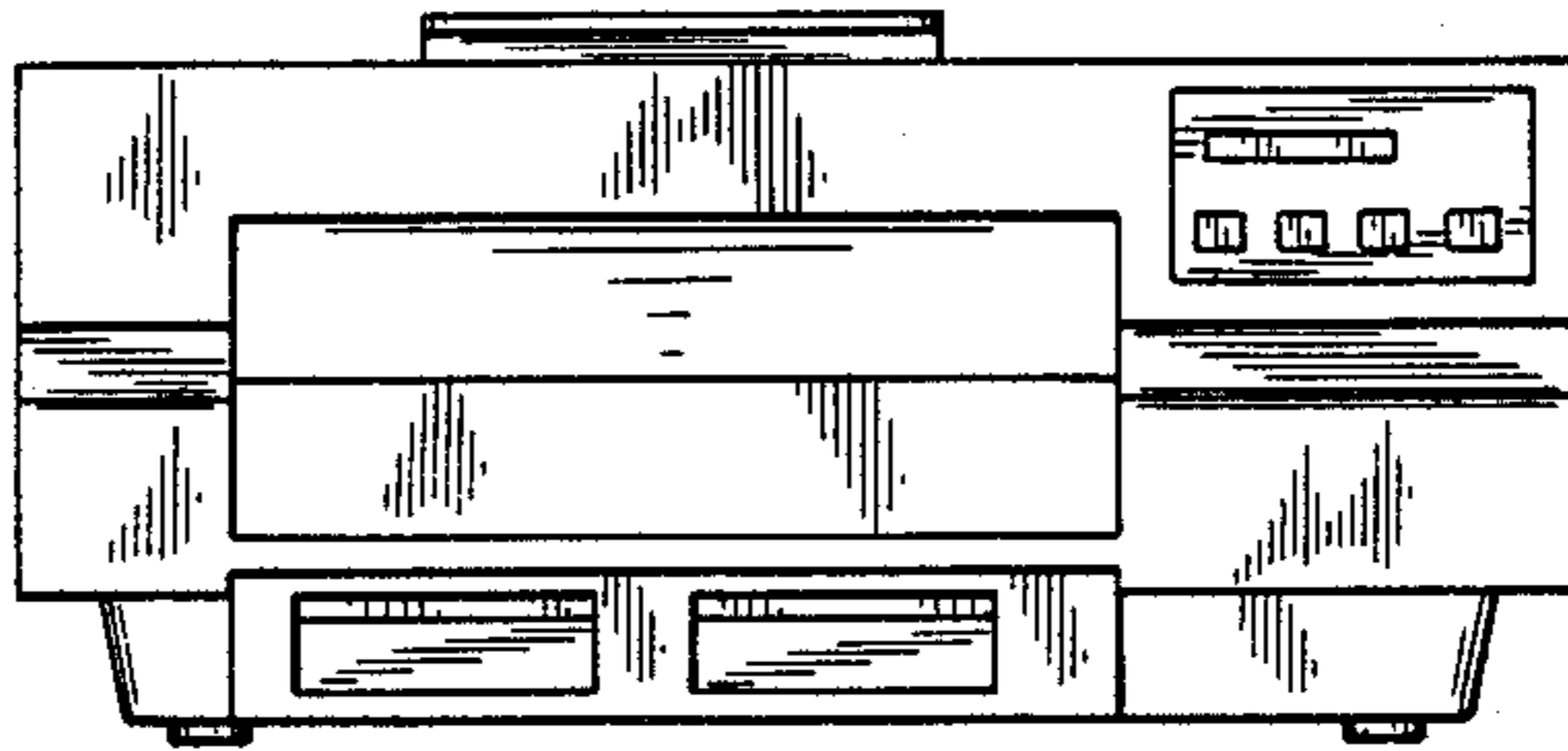

FIG. 2

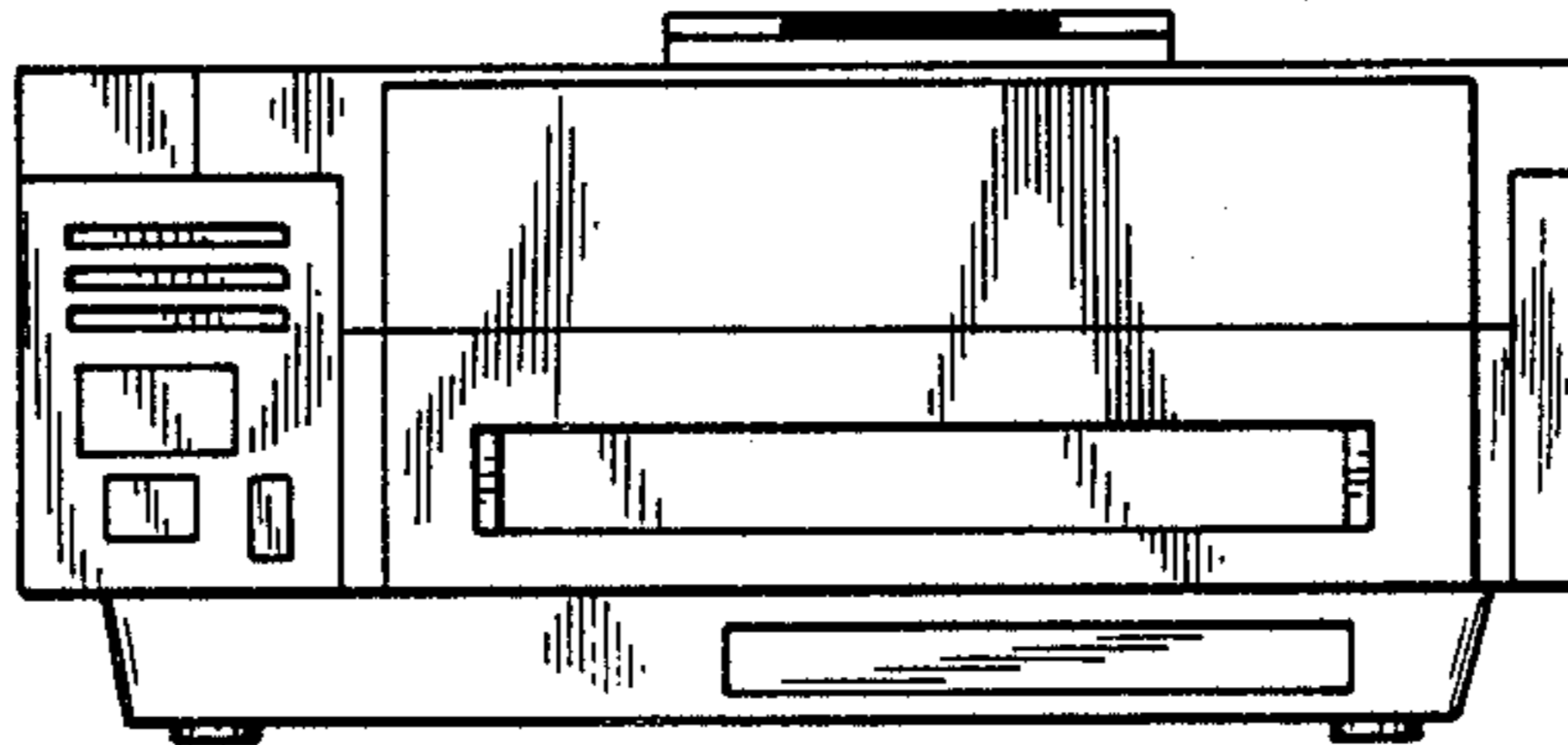

FIG. 3

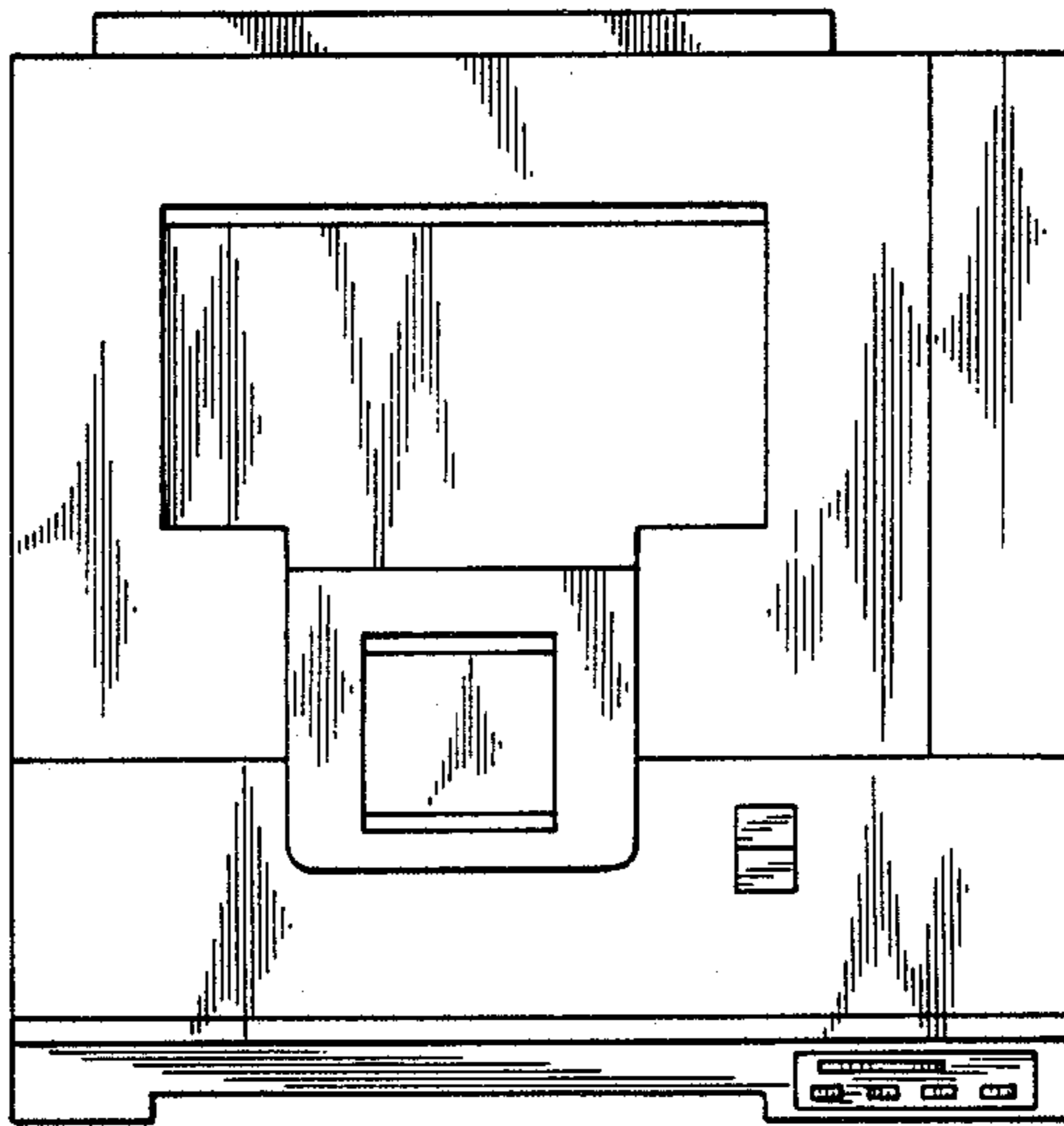

FIG. 4

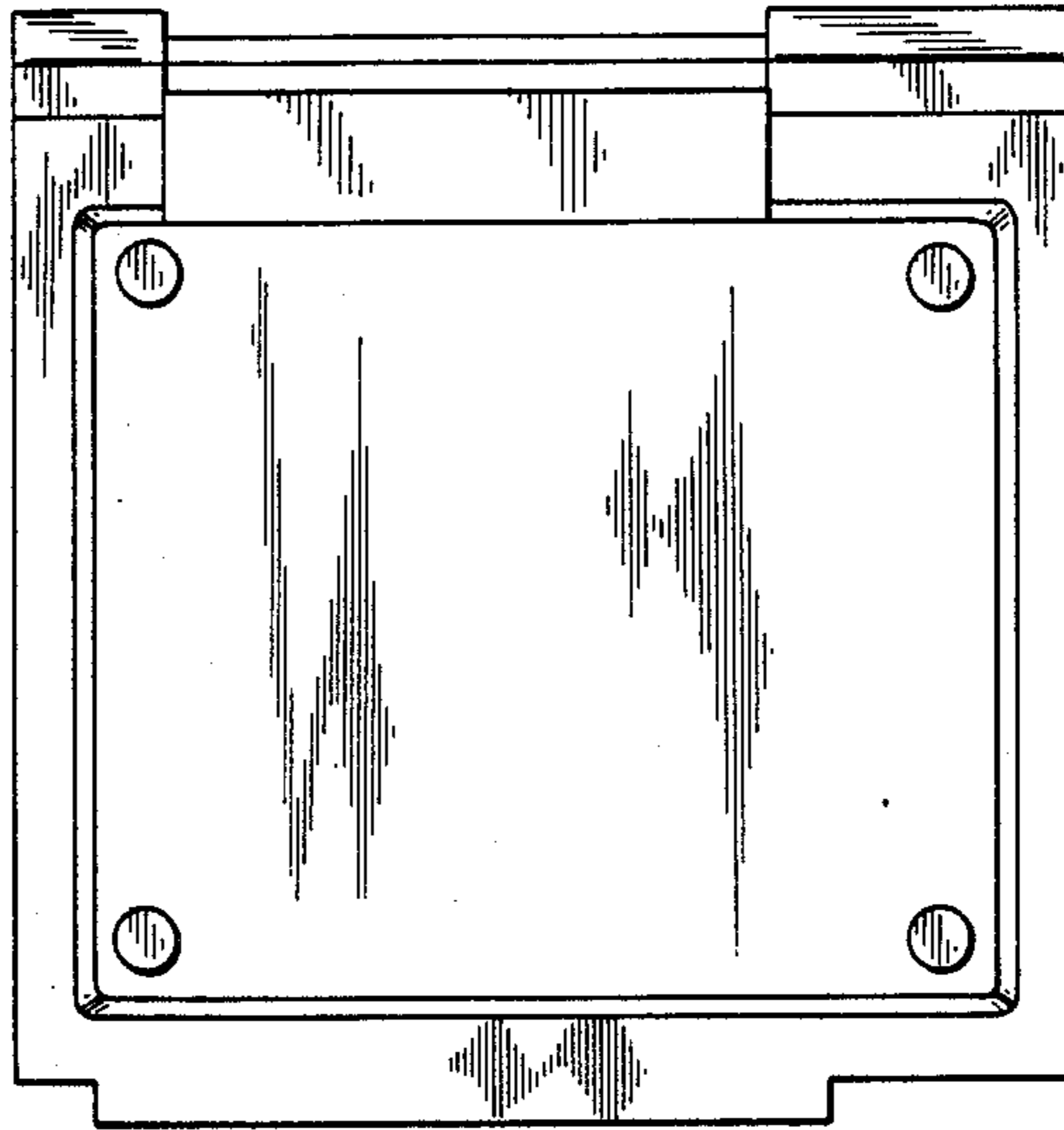

FIG. 5

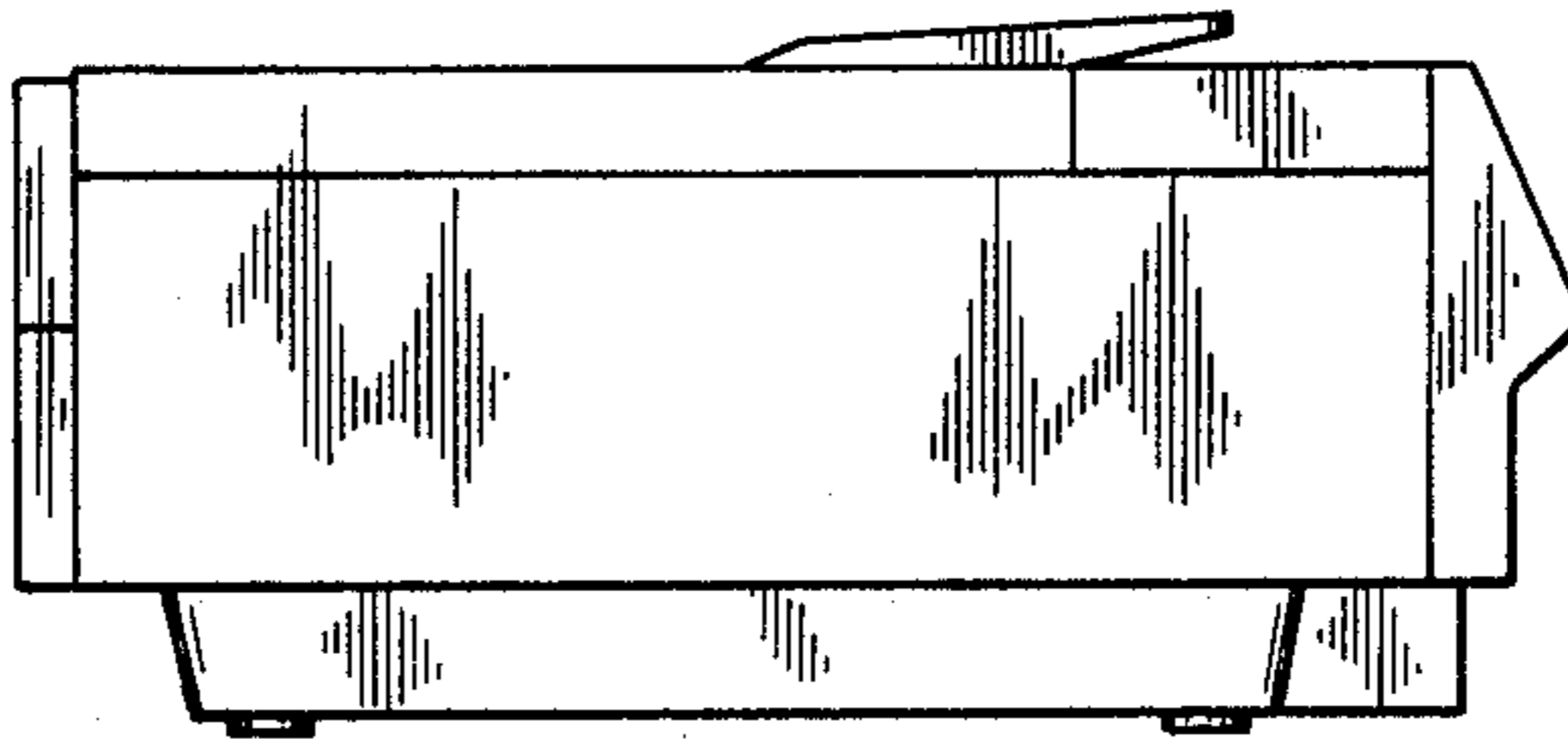

FIG. 6

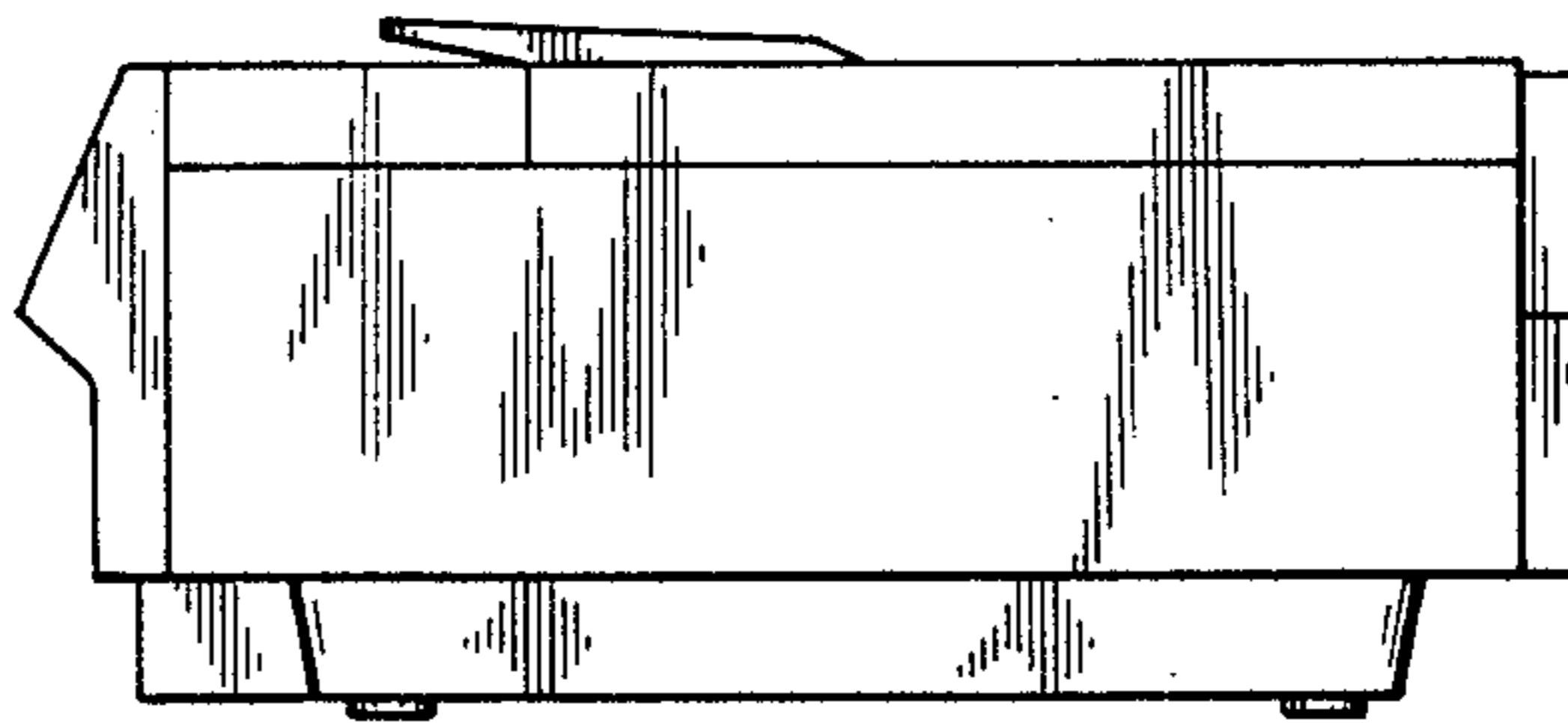

FIG. 7

