

[54] PAGING RECEIVER OR SIMILAR ARTICLE

[75] Inventors: David W. Davis, Boca Raton; William J. Scheid, Coral Springs, both of Fla.

[73] Assignee: Motorola, Inc., Schaumburg, Ill.

[\*\*] Term: 14 Years

[21] Appl. No.: 64,271

[22] Filed: Jun. 19, 1987

[52] U.S. Cl. .... D14/191

[58] Field of Search ..... D14/155, 168, 188, 189, D14/191, 192, 197, 198, 225, 226; 455/92, 100, 128, 351; 340/211.1, 825.44, 825.47, 825.48; D18/2, 6, 7

[56] References Cited

U.S. PATENT DOCUMENTS

- D. 259,722 6/1981 Fuller et al. .... D14/197
- D. 272,244 1/1984 Scheid ..... D14/191
- D. 281,777 12/1985 Matsumoto ..... D14/192
- D. 293,239 12/1987 Larson et al. .... D14/155

Primary Examiner—Bernard Ansher  
Assistant Examiner—Theodore M. Shooman  
Attorney, Agent, or Firm—Philip P. Macnak; Vincent B. Ingrassia

[57] CLAIM

The ornamental design for a paging receiver or similar article, as shown and described.

DESCRIPTION

FIG. 1 is a front bottom and left side perspective view of a paging receiver or similar article showing our new design;  
 FIG. 2 is a right side elevational view thereof;  
 FIG. 3 is a top plan view thereof;  
 FIG. 4 is a rear elevational thereof;  
 FIG. 5 is a front elevational view thereof;  
 FIG. 6 is a front elevational view of a second embodiment of the paging receiver or similar article illustrated in FIG. 1;  
 FIG. 7 is a front elevational view of a third embodiment of the paging receiver or similar article illustrated in FIG. 1;  
 FIG. 8 is a front elevational view of a fourth embodiment of the paging receiver or similar article illustrated in FIG. 1;  
 FIG. 9 is a front elevational view of a fifth embodiment of the paging receiver or similar article illustrated in FIG. 1;  
 FIG. 10 is a front elevational view of a sixth embodiment of the paging receiver or similar article illustrated in FIG. 1;  
 FIG. 11 is a front elevational view of a seventh embodiment of the paging receiver or similar article illustrated in FIG. 1; and  
 FIG. 12 is a front elevational view of a eighth embodiment of the paging receiver or similar article illustrated in FIG. 1.

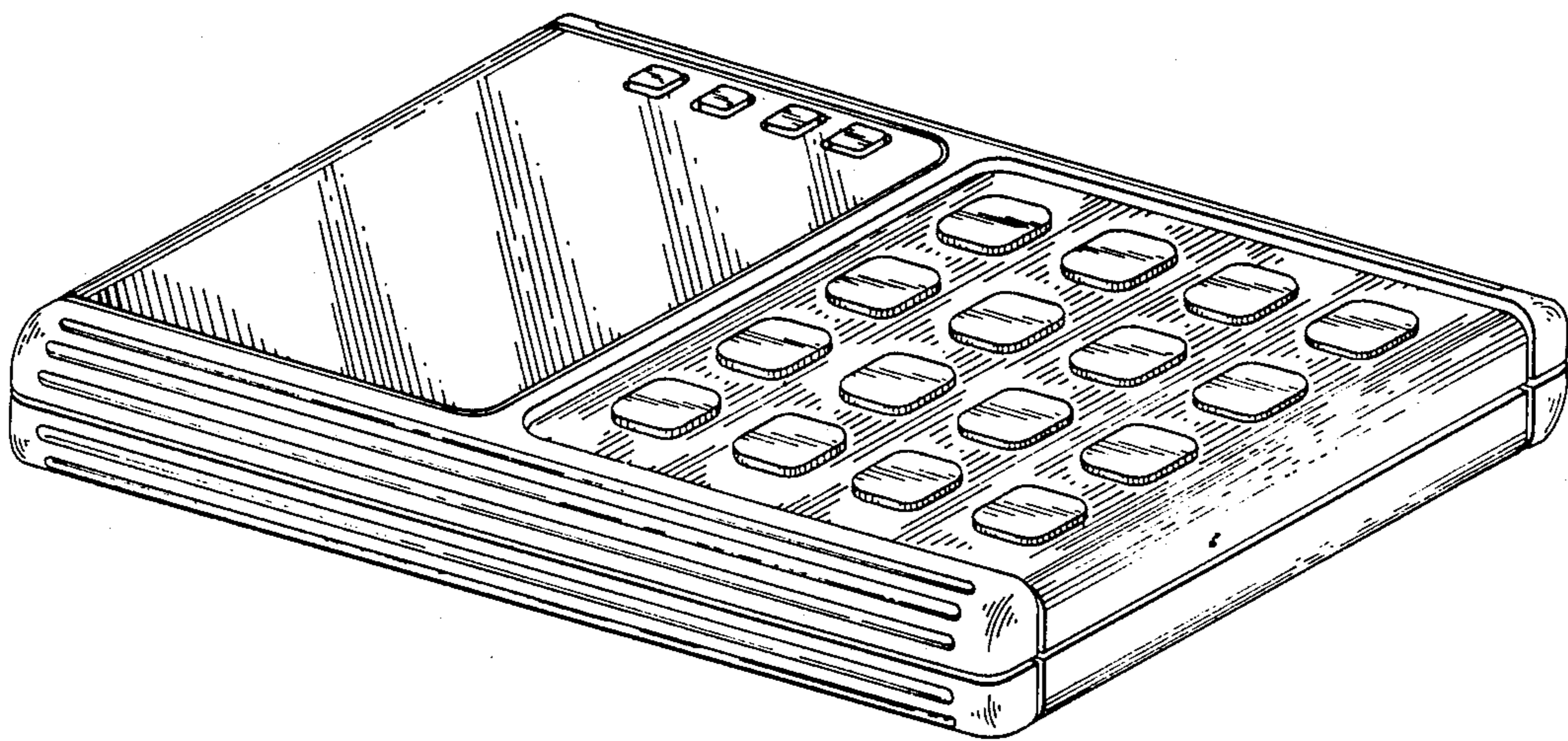

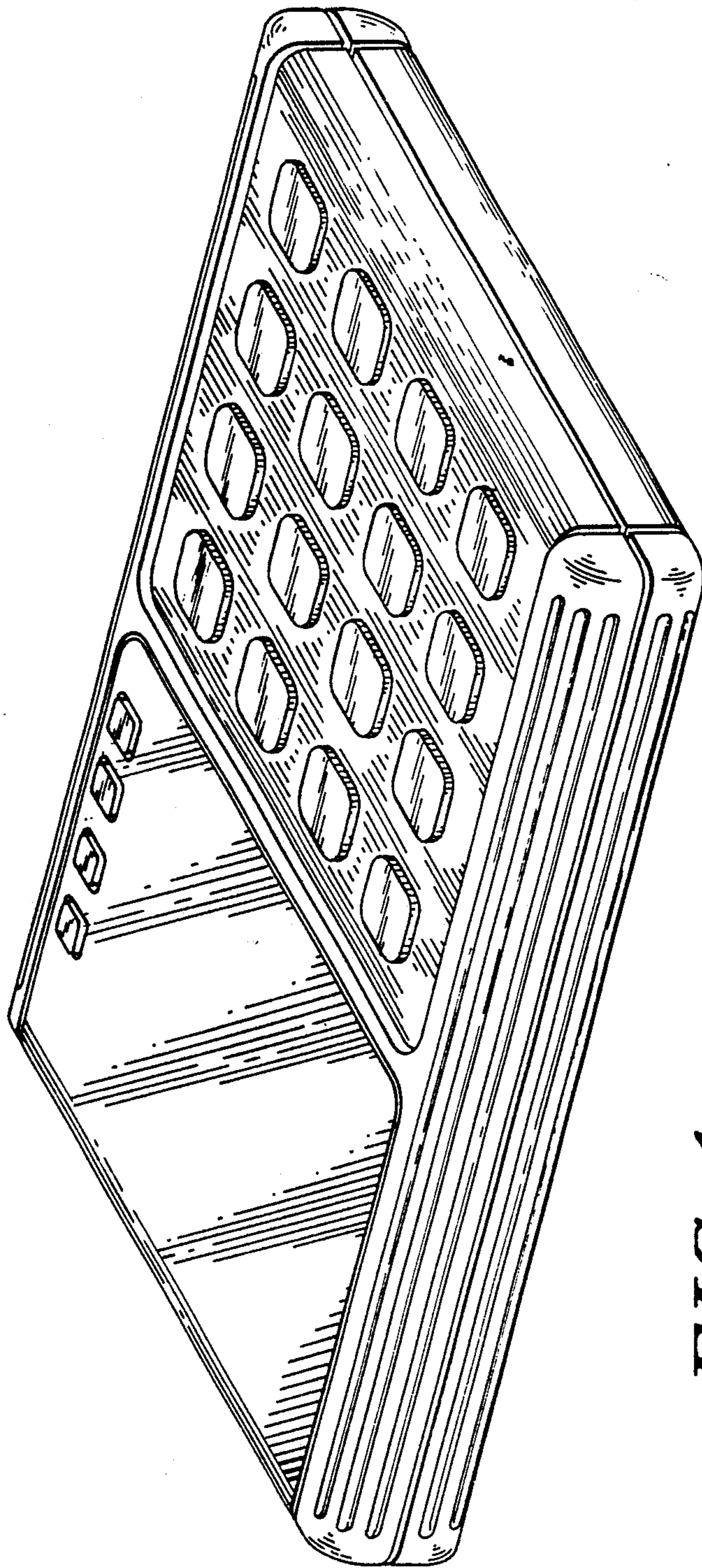

*FIG. 1*

*FIG. 2*

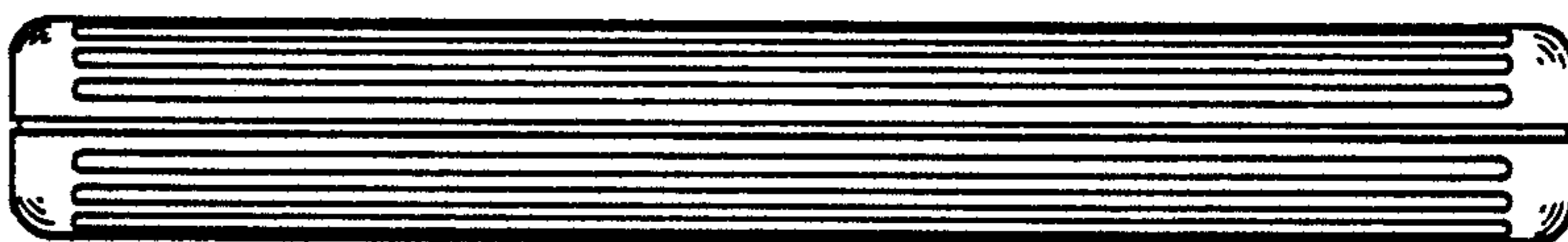
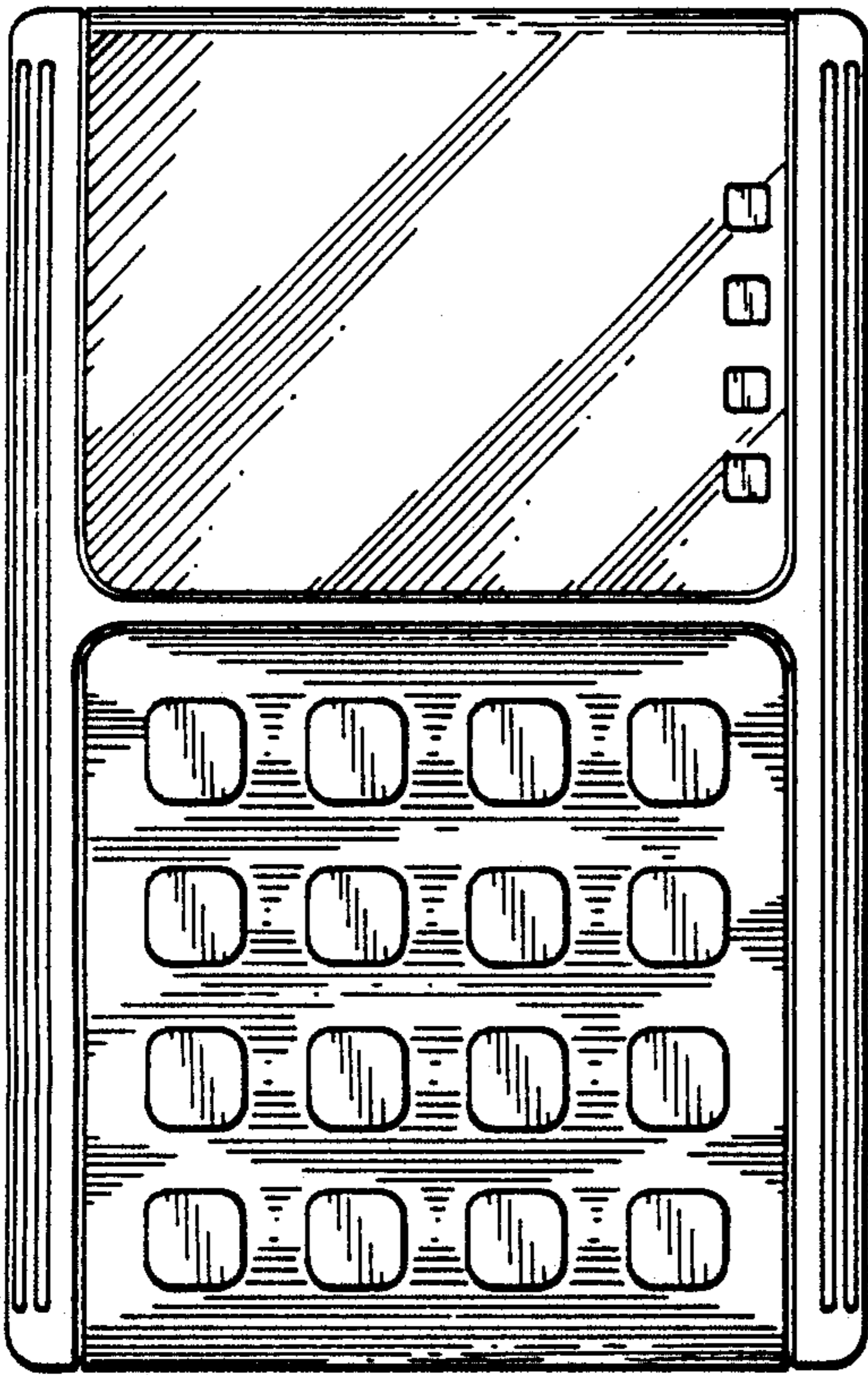

*FIG. 3*

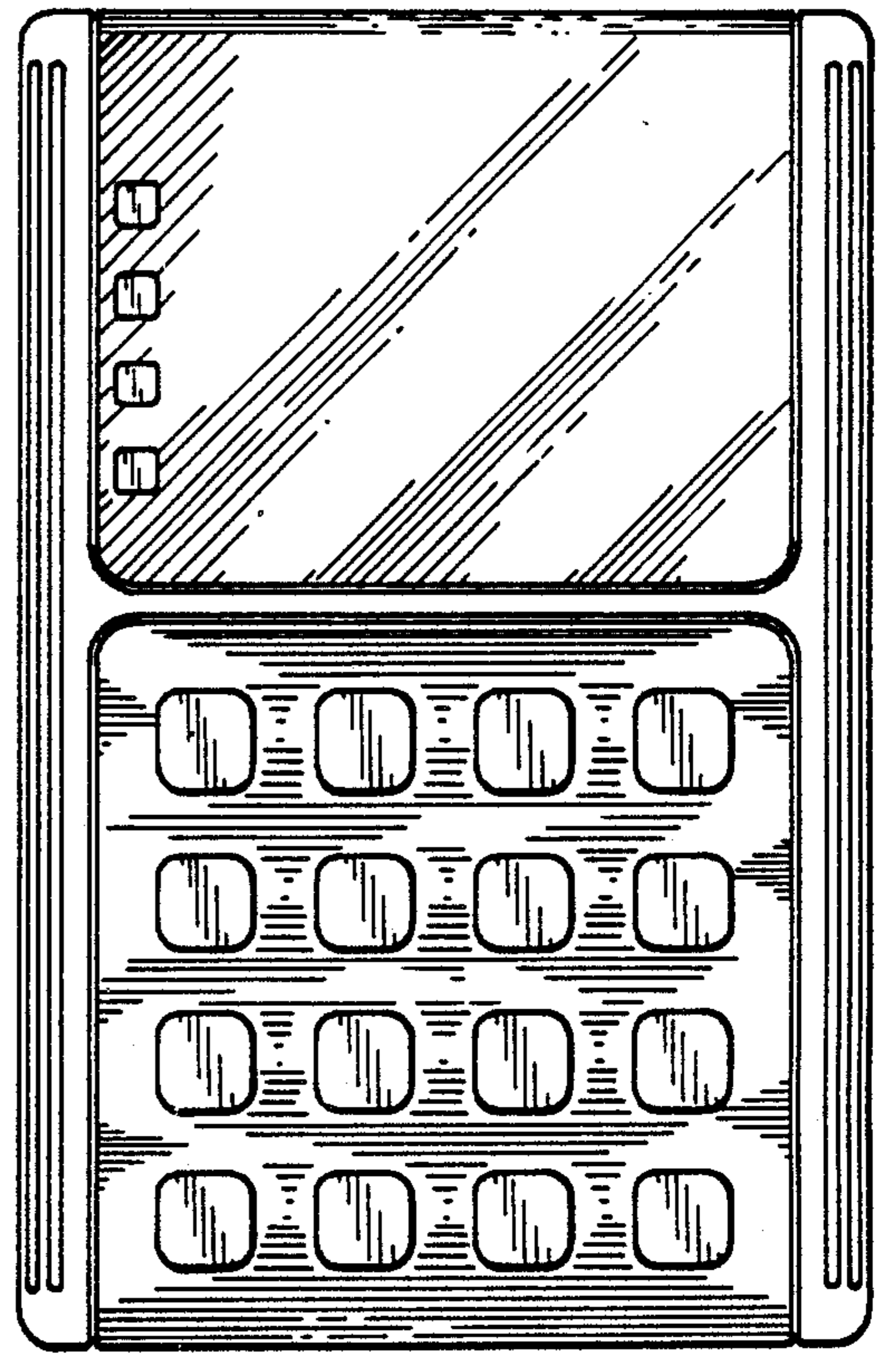

*FIG. 4*

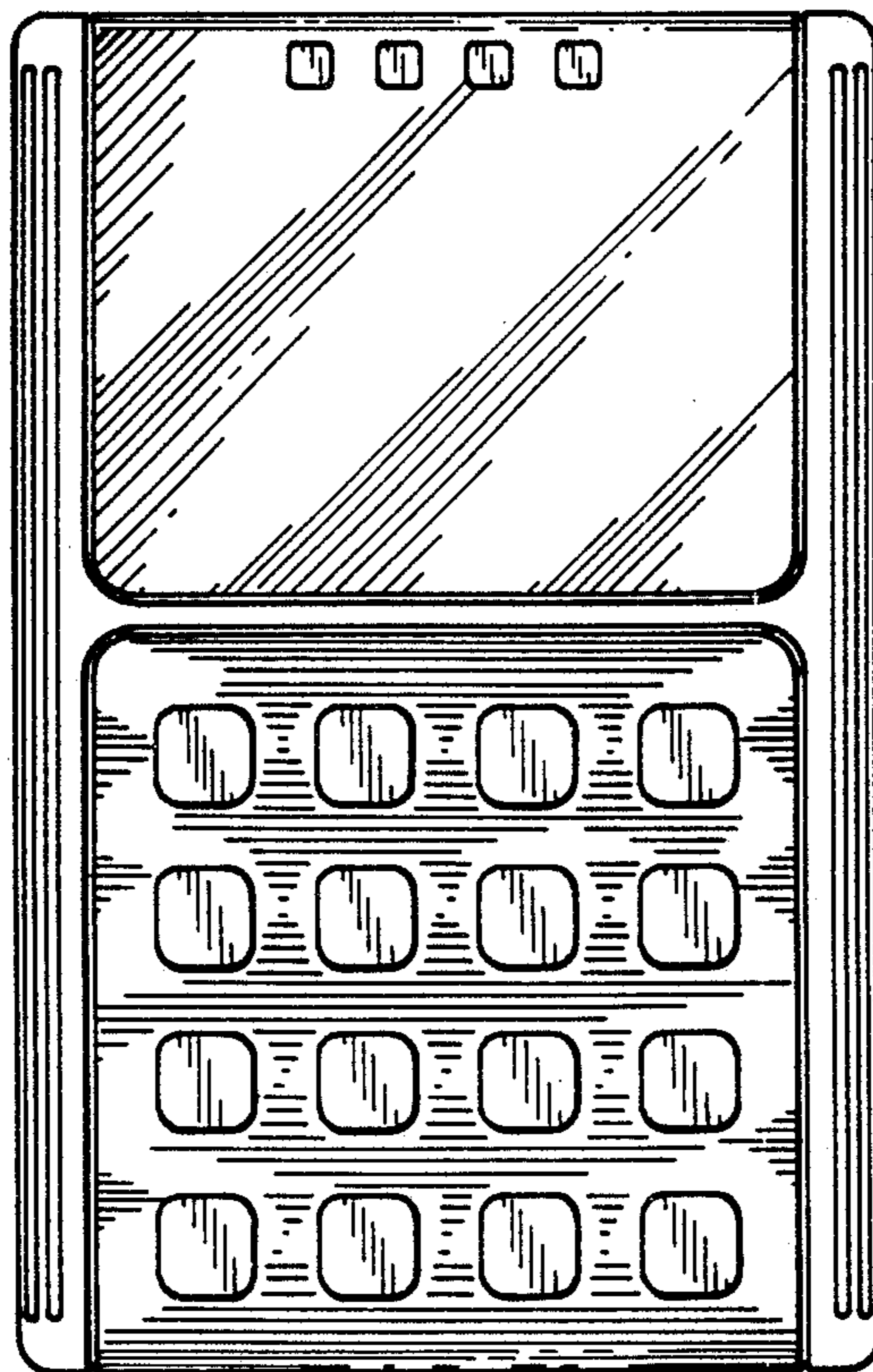



*FIG. 5*



*FIG. 6*



*FIG. 7*

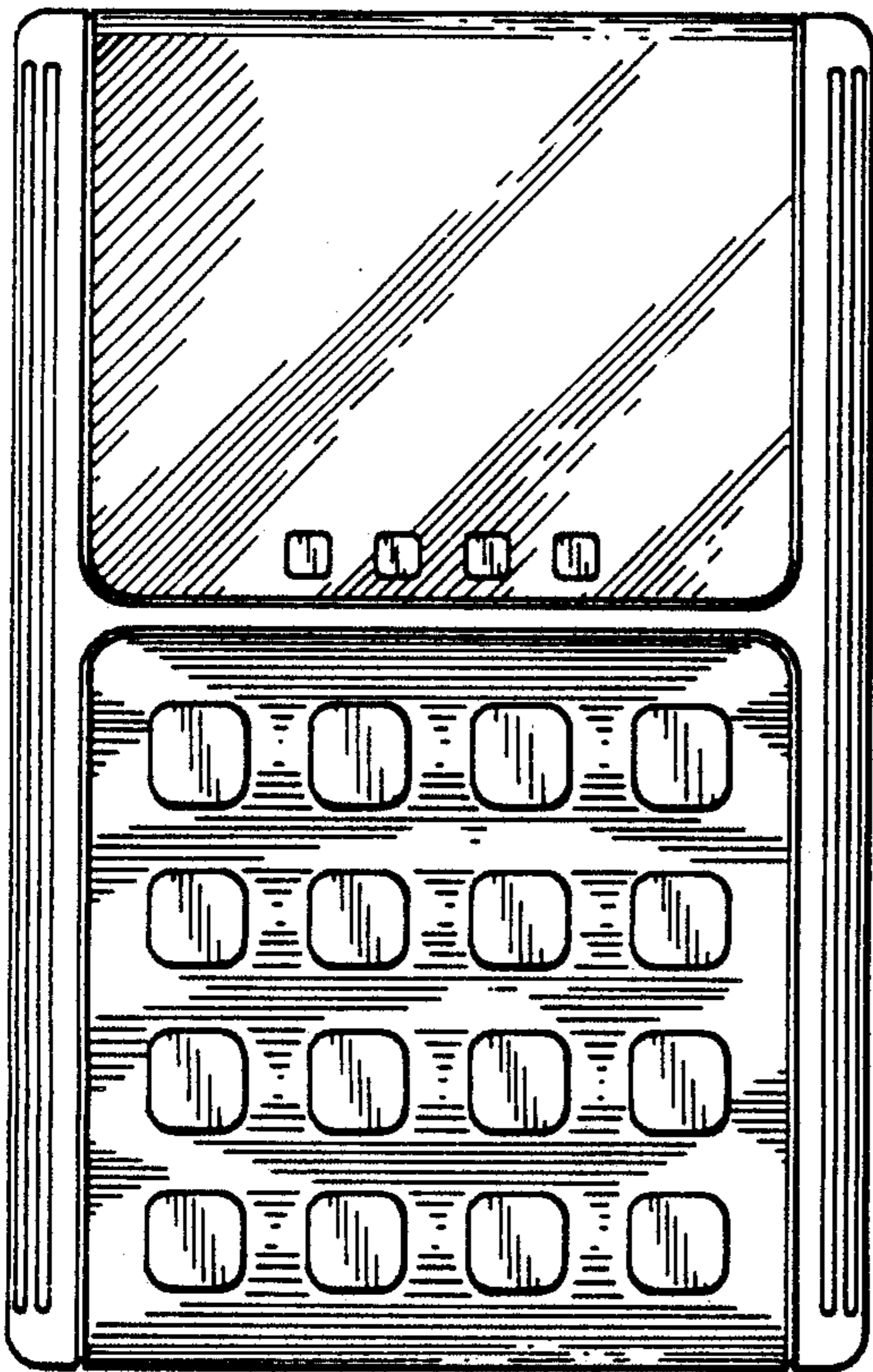

*FIG. 8*

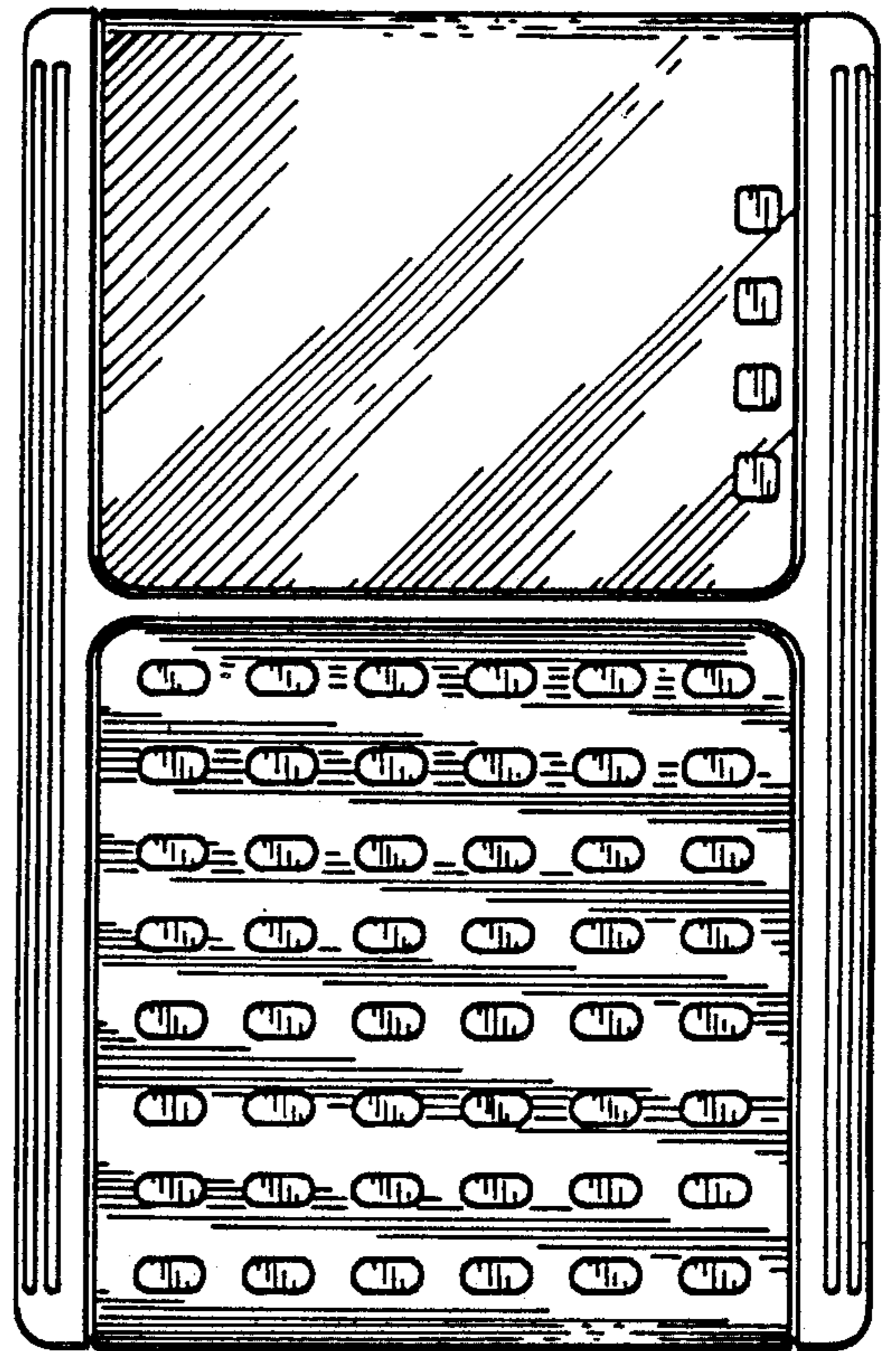

*FIG. 9*

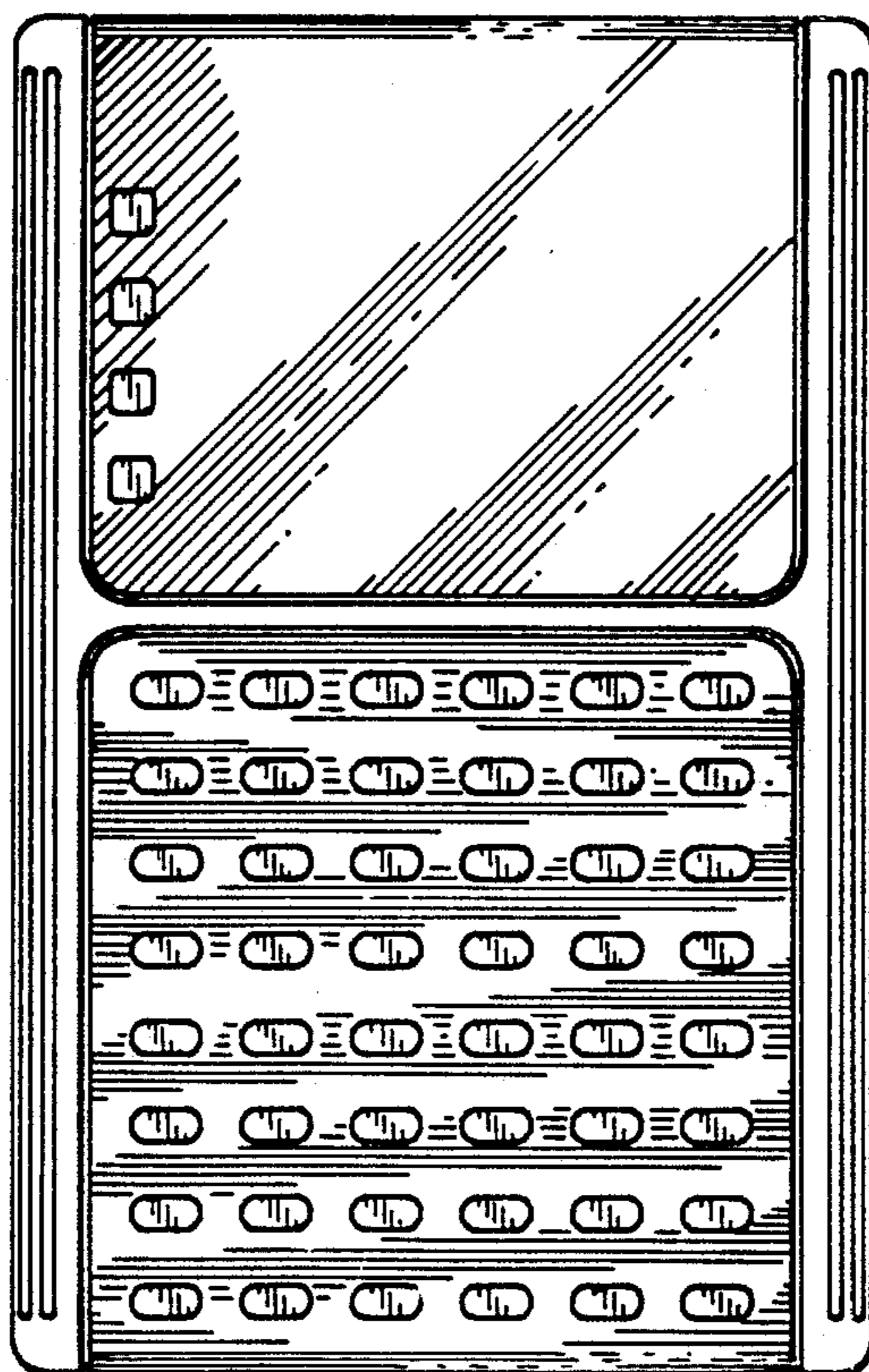

*FIG. 10*

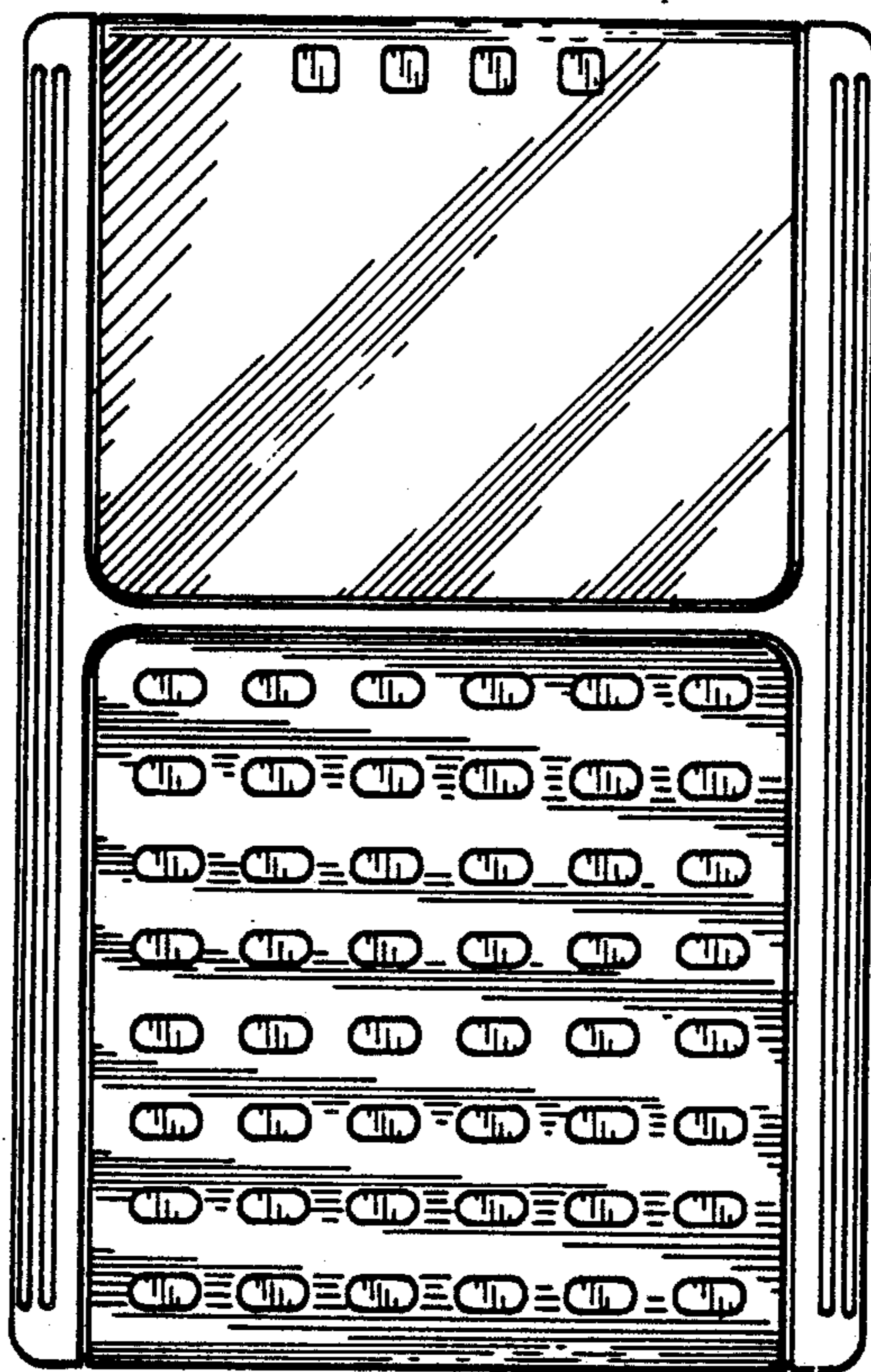

*FIG. 11*

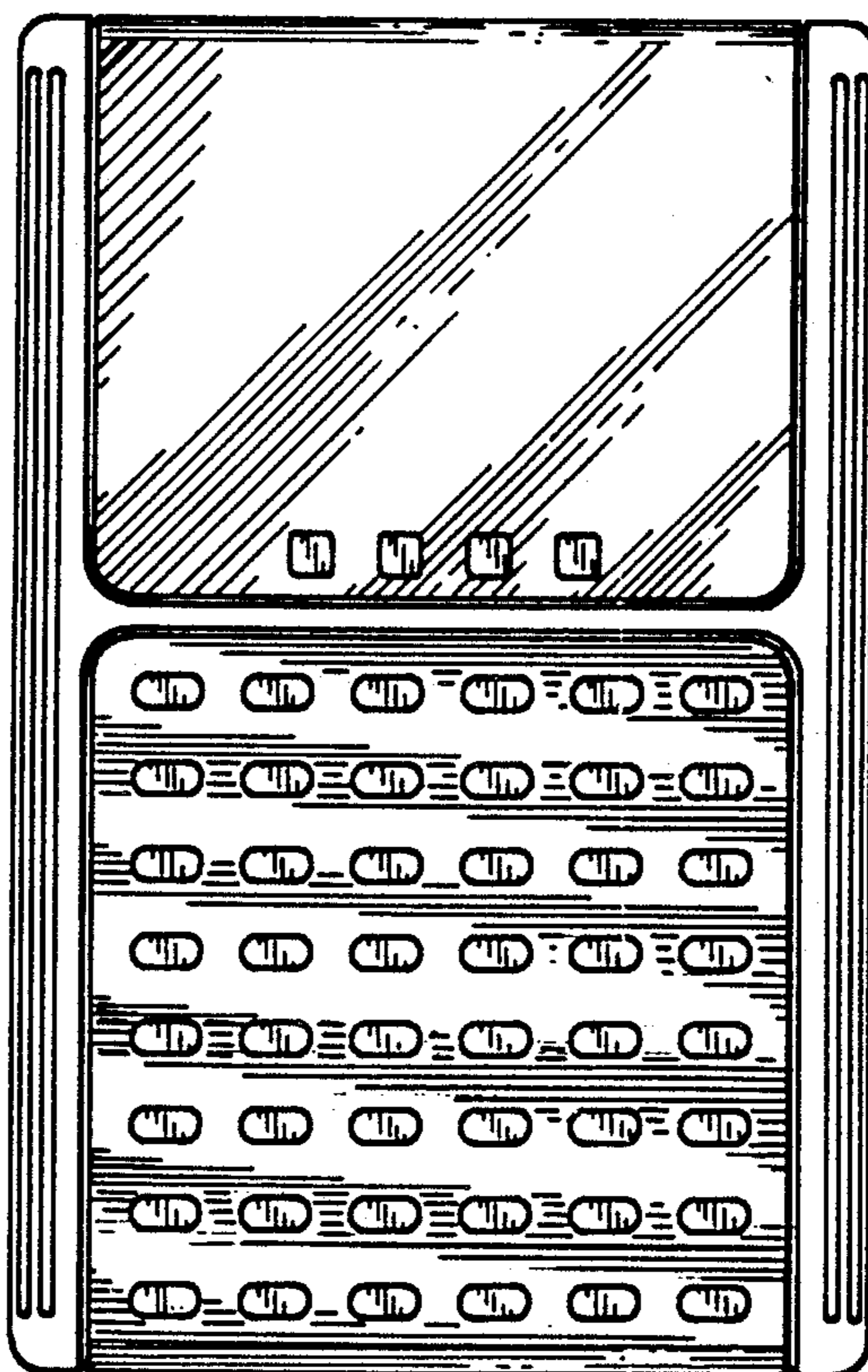

*FIG. 12*