

[54] COMBINED TAPE RECORDER, DIGITAL AUDIO DISC PLAYER AND RADIO

[75] Inventors: Kazuo Kawabe; Tsutomu Yamasaki, both of Osaka, Japan

[73] Assignee: Sharp Corporation, Osaka, Japan

[**] Term: 14 Years

[21] Appl. No.: 16,055

[22] Filed: Feb. 18, 1987

[30] Foreign Application Priority Data

Aug. 19, 1986 [JP] Japan 61-32357

[52] U.S. Cl. D14/163; D14/168

[58] Field of Search D14/154, 160-168, D14/188, 191-198, 299; 455/344, 347, 350, 351

[56] References Cited

U.S. PATENT DOCUMENTS

- D. 283,613 5/1986 Nakamura et al. D14/163
- D. 294,567 3/1988 Fujii D14/163
- D. 295,855 5/1988 Koo D14/163
- D. 297,834 9/1988 Kawabe et al. D14/163

OTHER PUBLICATIONS

Best Products 1986/87 Catalog, 8/29/86, p. 309, Item 9—Pasonic AM/FM Stereo Cassette Recorder.

Best Products 1986/87 Catalog, 8/29/86, p. 310, Item 5—Sharp AM/FM/FM Stereo Duel-Cassette Recorder.

Primary Examiner—Bernard Ansher
Assistant Examiner—Theodore M. Shooman
Attorney, Agent, or Firm—Flehr, Hohbach, Test, Albritton & Herbert

[57] CLAIM

The ornamental design for a combined tape recorder, digital audio disc player and radio, as shown and described.

DESCRIPTION

FIG. 1 is a top and front perspective view of a combined tape recorder, digital audio disc player and radio showing our new design, with the antenna and handle in a raised position and the tape and disc holders in an open position;

FIG. 2 is a front elevational view thereof;

FIG. 3 is a rear elevational view thereof;

FIG. 4 is a top plan view thereof;

FIG. 5 is a bottom plan view thereof;

FIG. 6 is a right side elevational view thereof;

FIG. 7 is a left side elevational view thereof; and

FIG. 8 is a sectional view taken along the line 8—8 of FIG. 2.

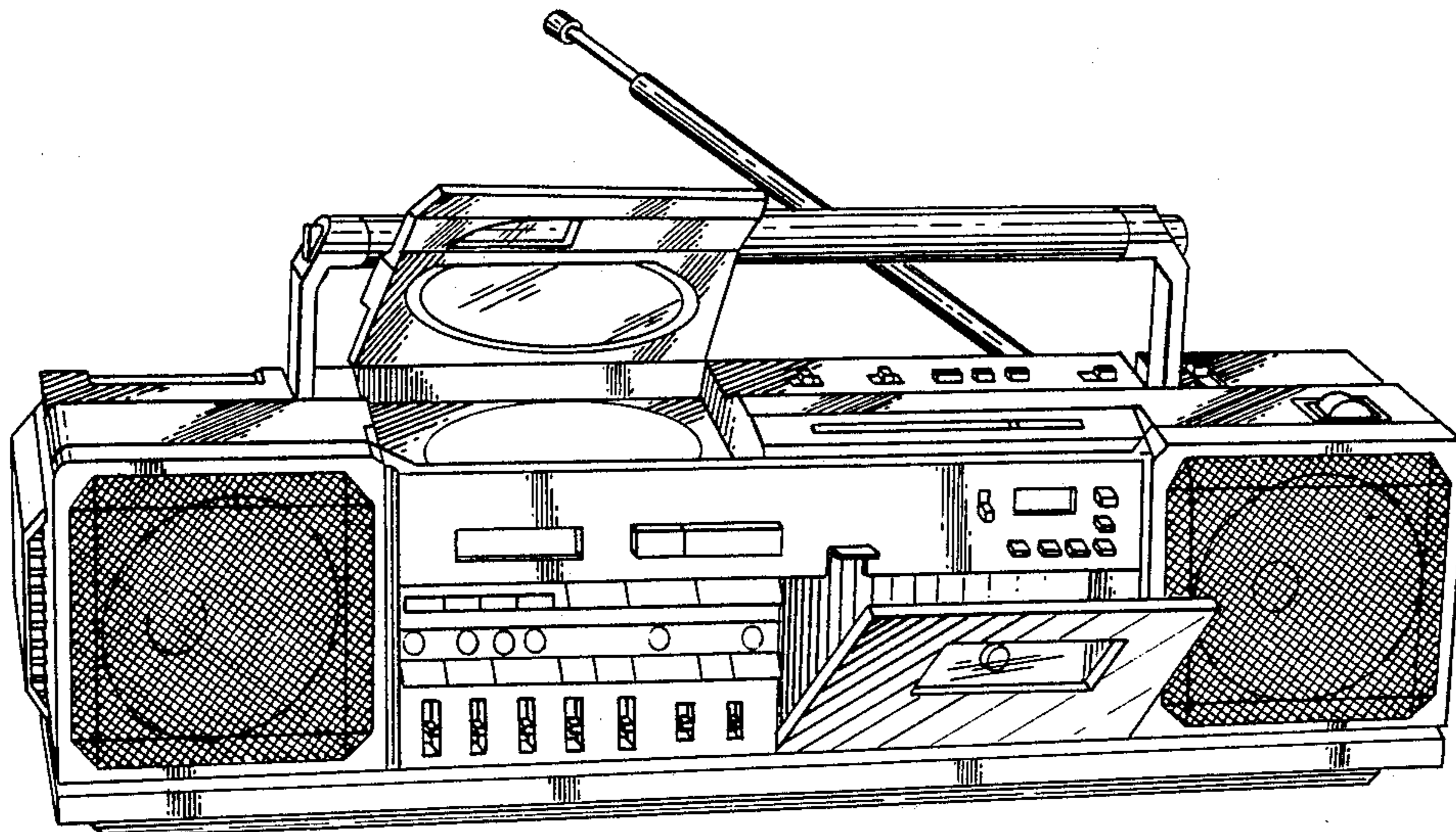

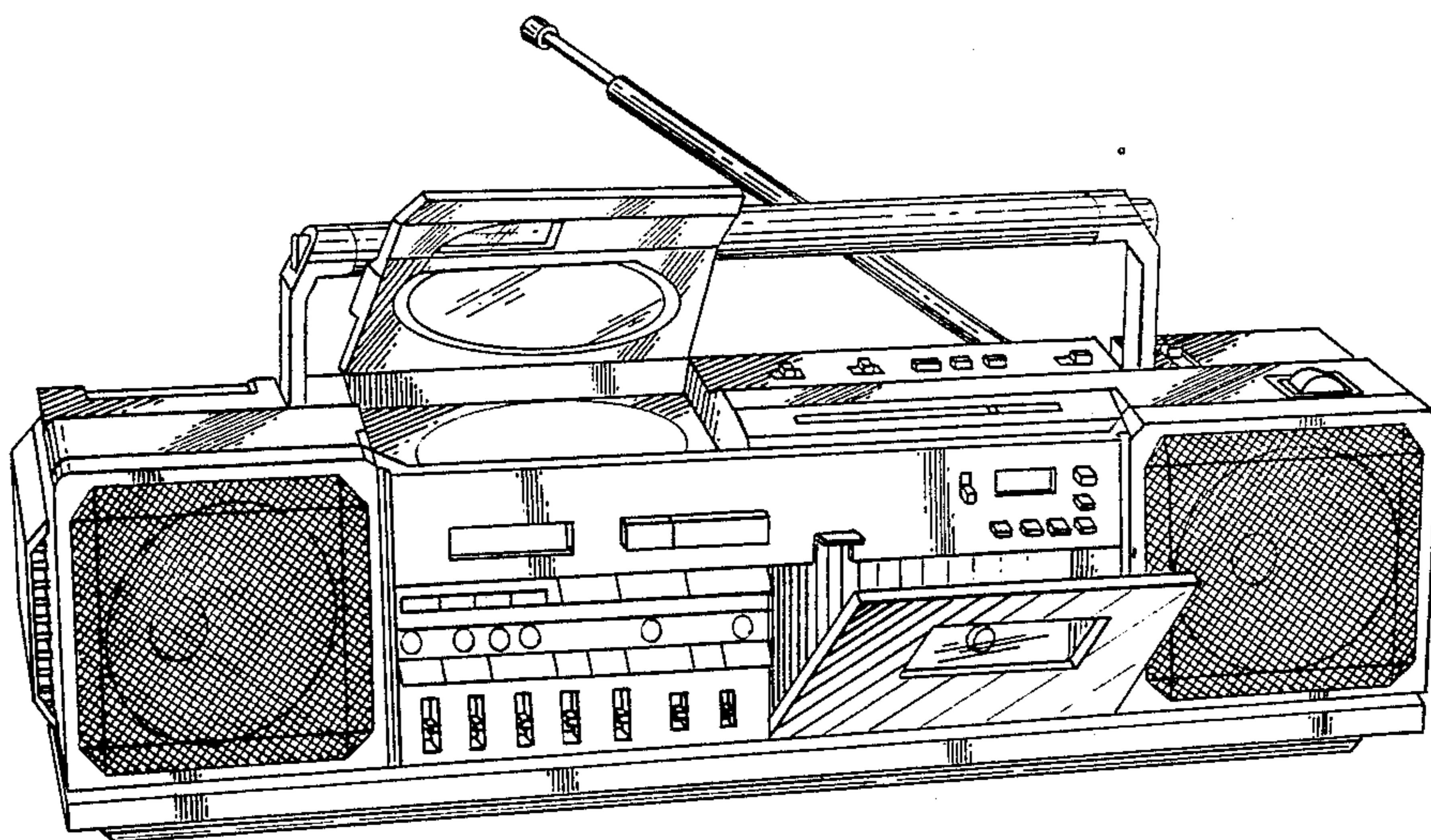

FIG. 1

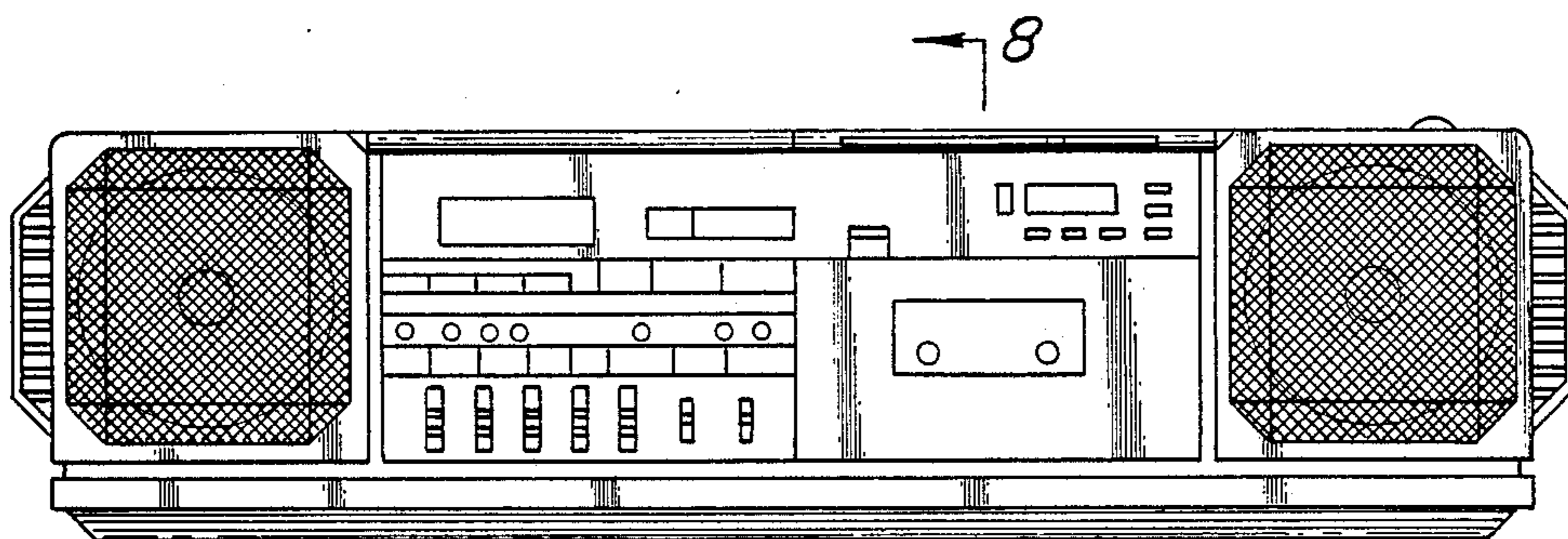

FIG. 2

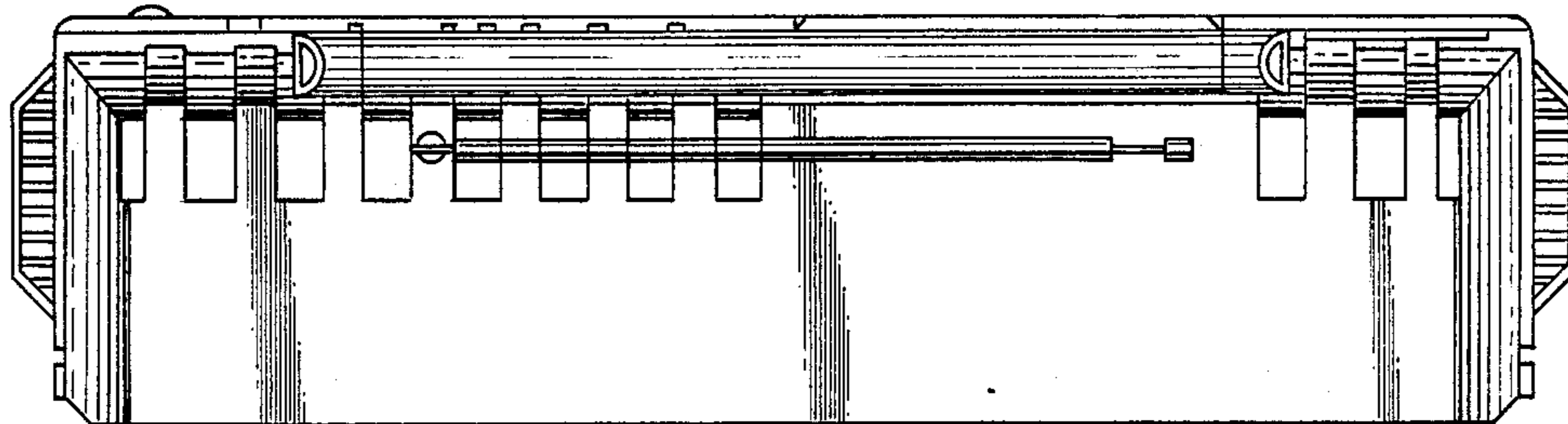

FIG. 3

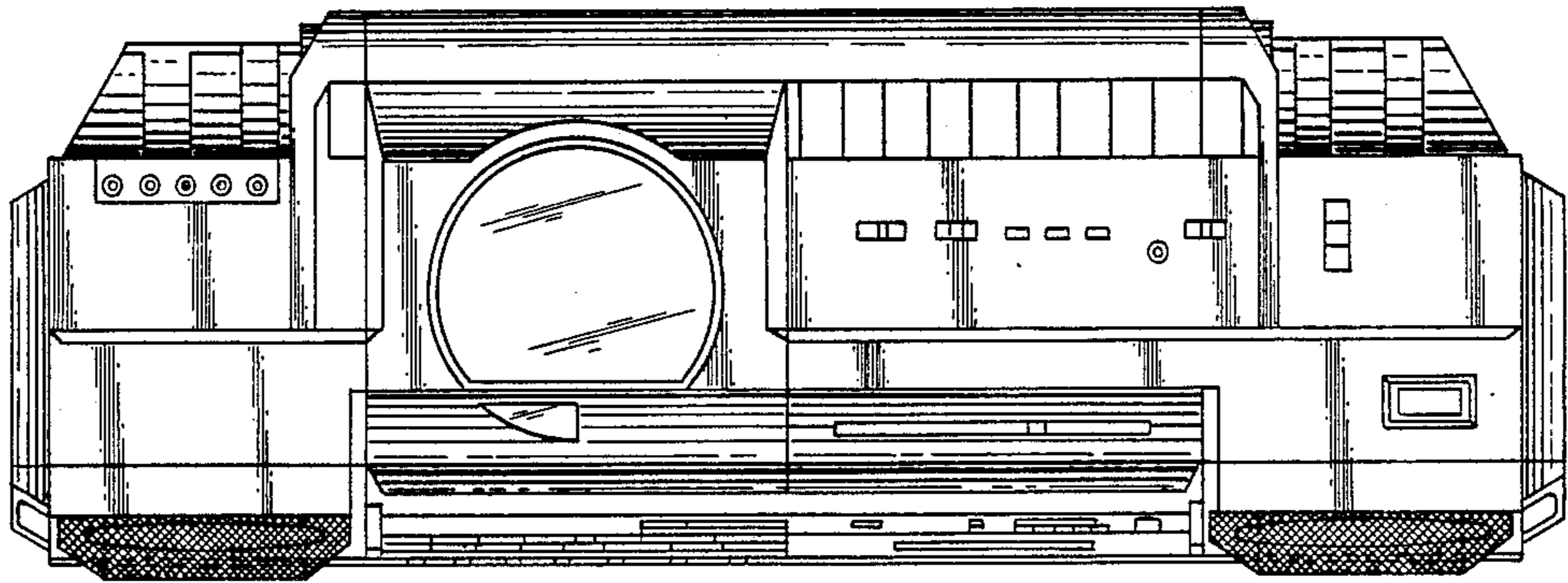

FIG. 4

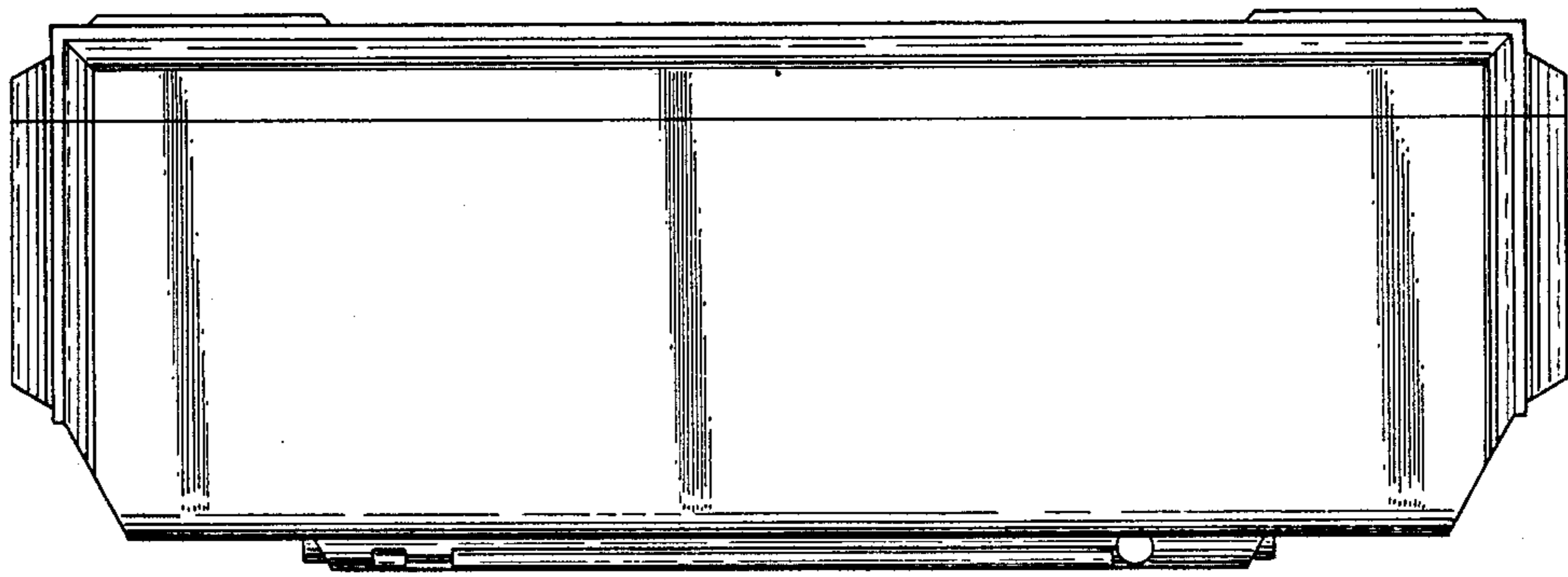

FIG. 5

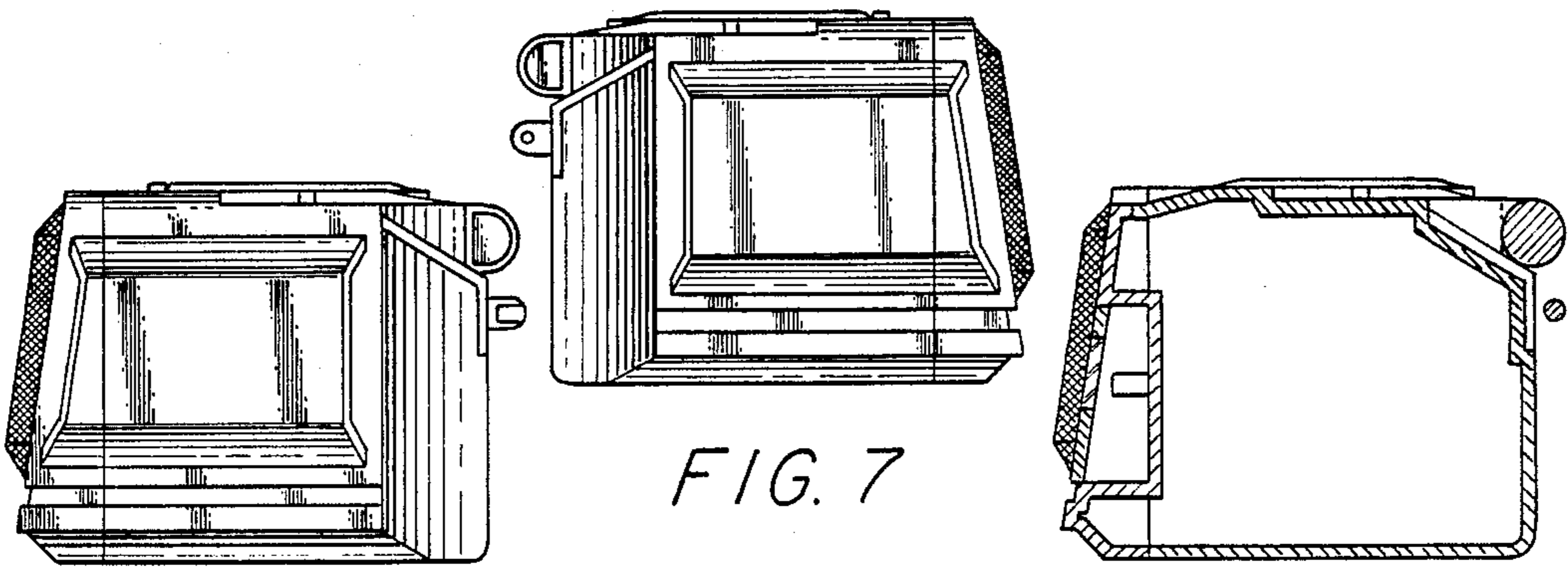

FIG. 6

FIG. 7

FIG. 8