

[54] GOLF BALL PACKAGE

[75] Inventor: Michael R. Ferris, Feeding Hills, Mass.

[73] Assignee: Spalding & Evenflo Companies, Inc., Tampa, Fla.

[**] Term: 14 Years

[21] Appl. No.: 122,432

[22] Filed: Nov. 18, 1987

[52] U.S. Cl. D9/415

[58] Field of Search D9/415, 418, 420, 425, D9/426, 345; 206/461-471, 315.1, 315.3, 315.9, 303, 822; 224/918, 919

[56] References Cited

U.S. PATENT DOCUMENTS

D. 234,294	2/1975	Gorman	D9/415	X
D. 244,429	5/1977	Gardner	D9/415	
D. 260,488	9/1981	Kinneary	D9/418	
3,313,194	4/1967	Hanscom	206/461	X

3,939,979	2/1976	Neumayer	206/461	
3,943,989	3/1976	Sperling	206/470	X
4,444,310	4/1984	Odell	206/461	X
4,498,589	2/1985	Scott et al.	206/470	X

Primary Examiner—Bernard Ansher
Assistant Examiner—Prabhakar Deshmukh
Attorney, Agent, or Firm—Donald R. Bahr

[57] CLAIM

The ornamental design for a golf ball package, as shown and described.

DESCRIPTION

FIG. 1 is a rear side elevation of a golf ball package showing my new design;
FIG. 2 is a top plan view thereof;
FIG. 3 is a bottom plan view thereof;
FIG. 4 is a front elevation thereof;
FIG. 5 is a left side elevation thereof, the right side elevation being a mirror image; and
FIG. 6 is a perspective view thereof, in an open position.

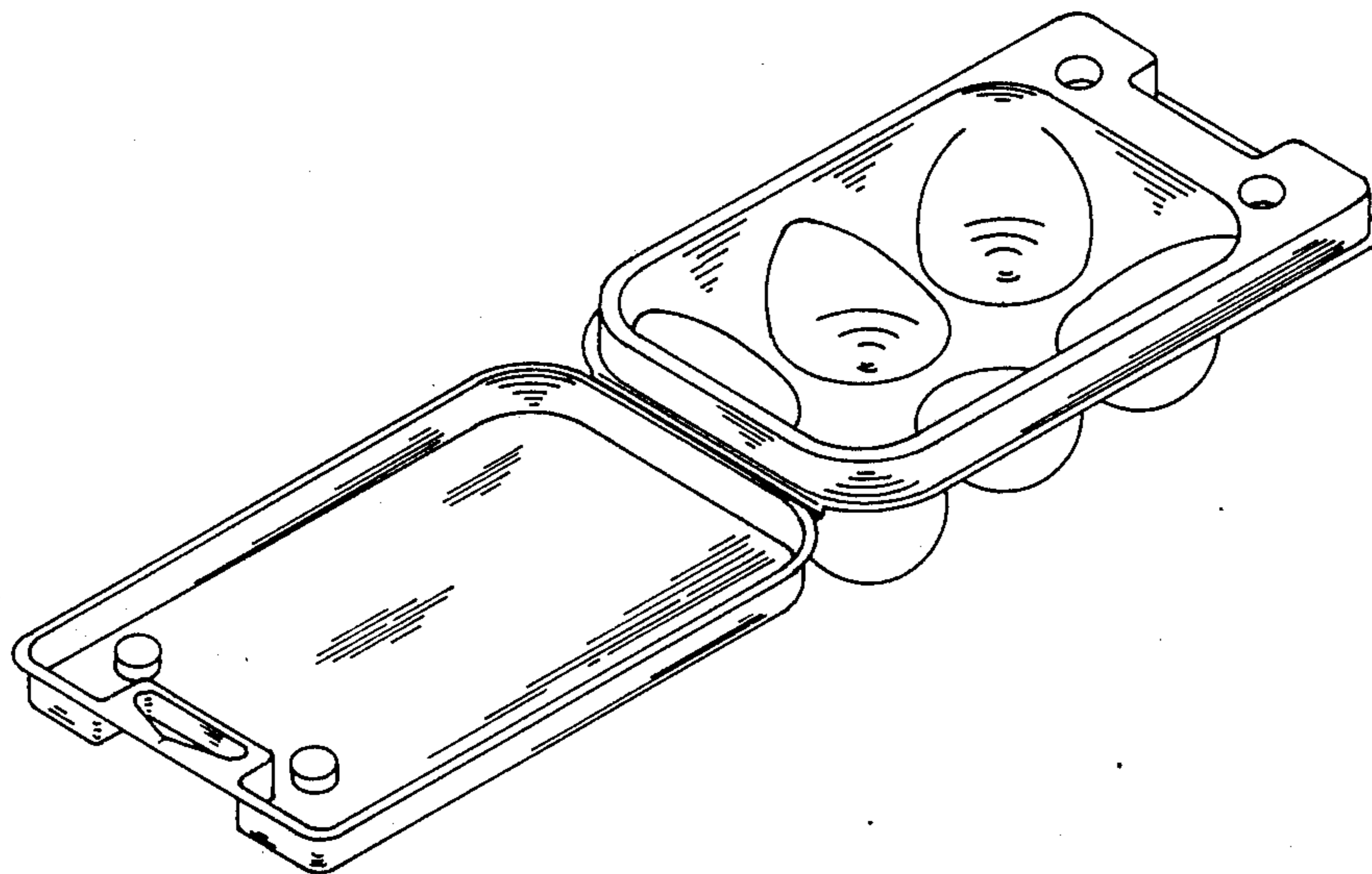

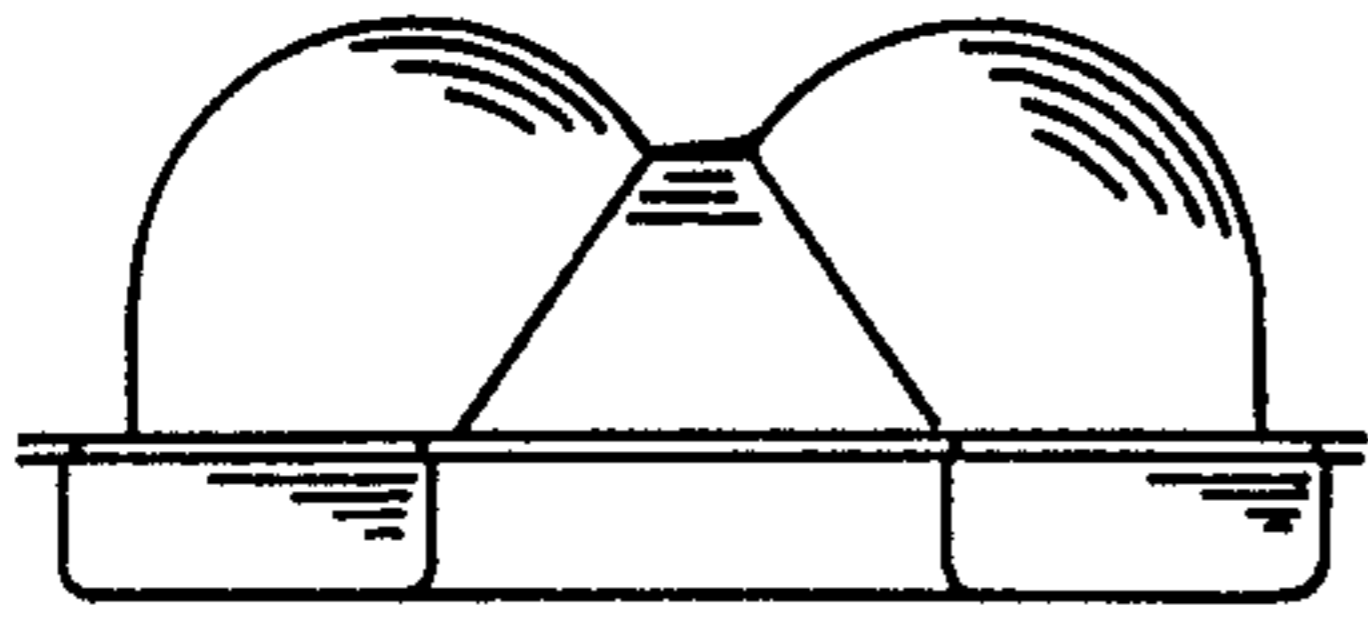

FIG. 2

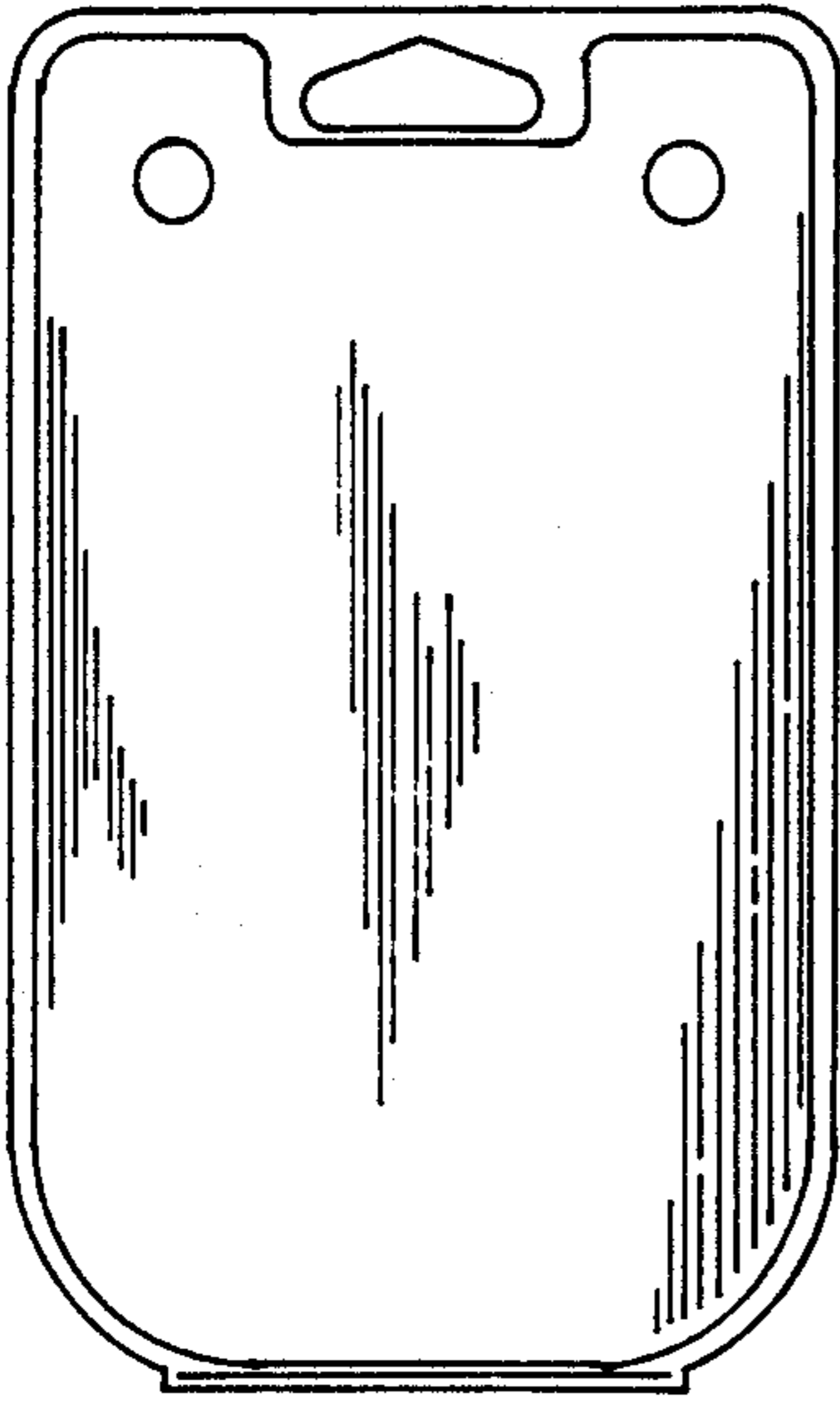

FIG. 1

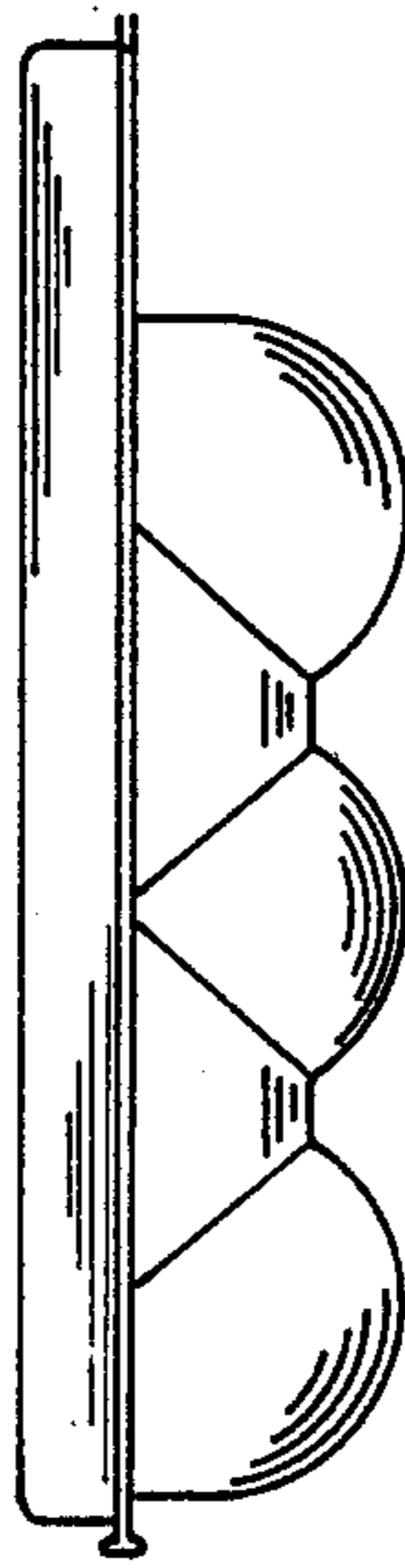

FIG. 5

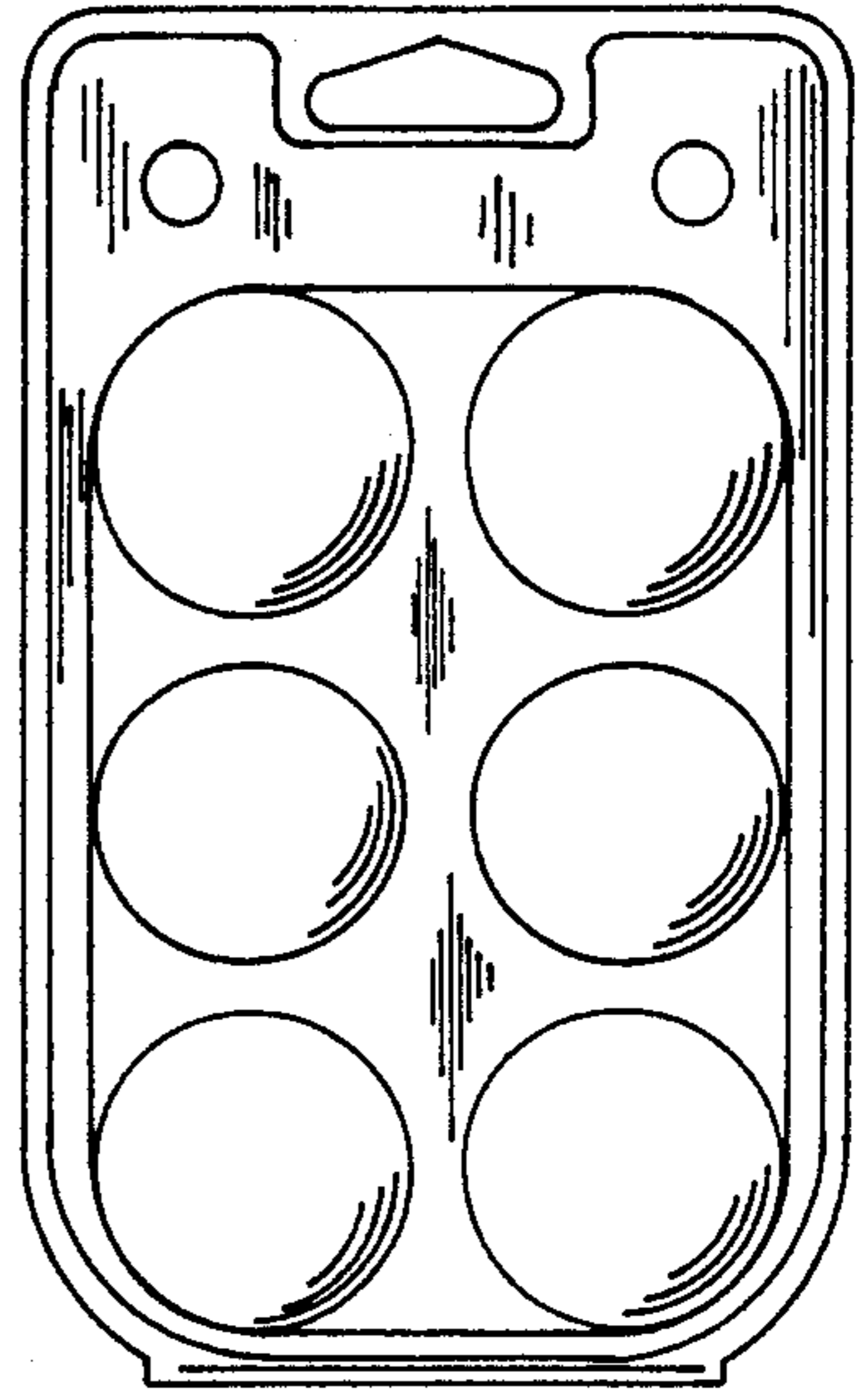

FIG. 4

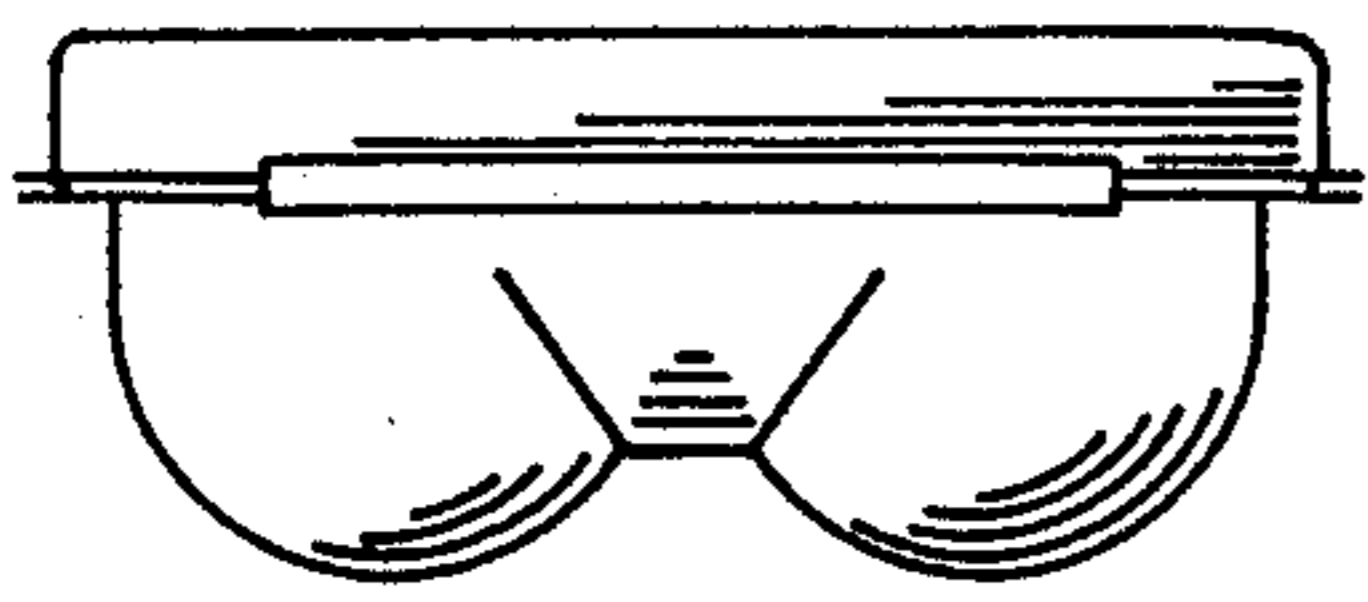

FIG. 3

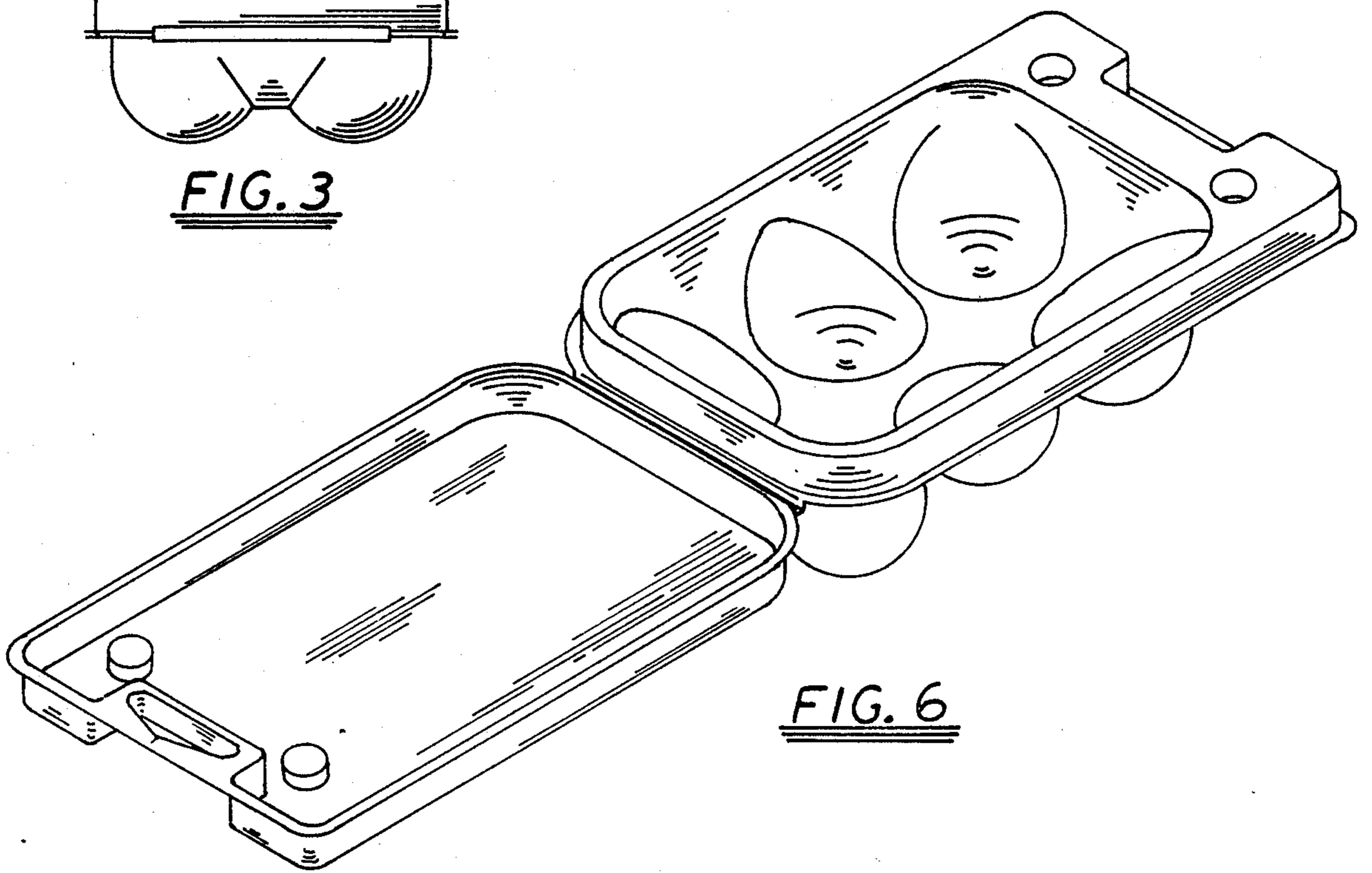

FIG. 6