

[54] CABINET

[75] Inventor: Thomas J. Newhouse, Grand Rapids, Mich.

[73] Assignee: Herman Miller, Inc., Zeeland, Mich.

[**] Term: 14 Years

[21] Appl. No.: 57,829

[22] Filed: Jun. 2, 1987

[52] U.S. Cl. D6/446

[58] Field of Search D6/441, 446, 448, 432; 312/204, 253

[56] References Cited

U.S. PATENT DOCUMENTS

D. 60,965	5/1922	Schoeck	D6/441
D. 168,841	2/1953	Herrman et al.	D6/441
D. 239,350	3/1976	Vogt	.	
D. 281,299	11/1985	Esslinger	.	
3,635,174	1/1972	Ball et al.	.	
3,786,765	1/1974	Burr	.	
4,296,981	10/1981	Hildebrandt et al.	.	
4,323,291	4/1982	Ball	.	
4,555,150	11/1985	Turnball	.	

OTHER PUBLICATIONS

Office Appliances 10/59, p. 152; 4 Drawer Cabinet Item #4DF center on page.

Canto Collection brochure by Stowe & Davis Company, Inc., 1985.

Primary Examiner—Carmen H. Vales-Lado
Attorney, Agent, or Firm—Varnum, Riddering, Schmidt & Howlett

[57] CLAIM

The ornamental design for a cabinet, as shown and described.

DESCRIPTION

FIG. 1 is a front perspective view of a cabinet showing my new design;
 FIG. 2 is a front elevational view thereof;
 FIG. 3 is a rear elevational view thereof;
 FIG. 4 is a top plan view thereof;
 FIG. 5 is a right side elevational view, the left side being a mirror image thereof;
 FIG. 6 is a front perspective view of a second embodiment of the cabinet shown in FIG. 1;
 FIG. 7 is a right side elevational view the left side being a mirror image thereof;
 FIG. 8 is a top plan view thereof;
 FIG. 9 is a front elevational view of a third embodiment of the cabinet shown in FIG. 1;
 FIG. 10 is a right side elevational view the left side being a mirror image thereof; and
 FIG. 11 is a top plan view thereof.

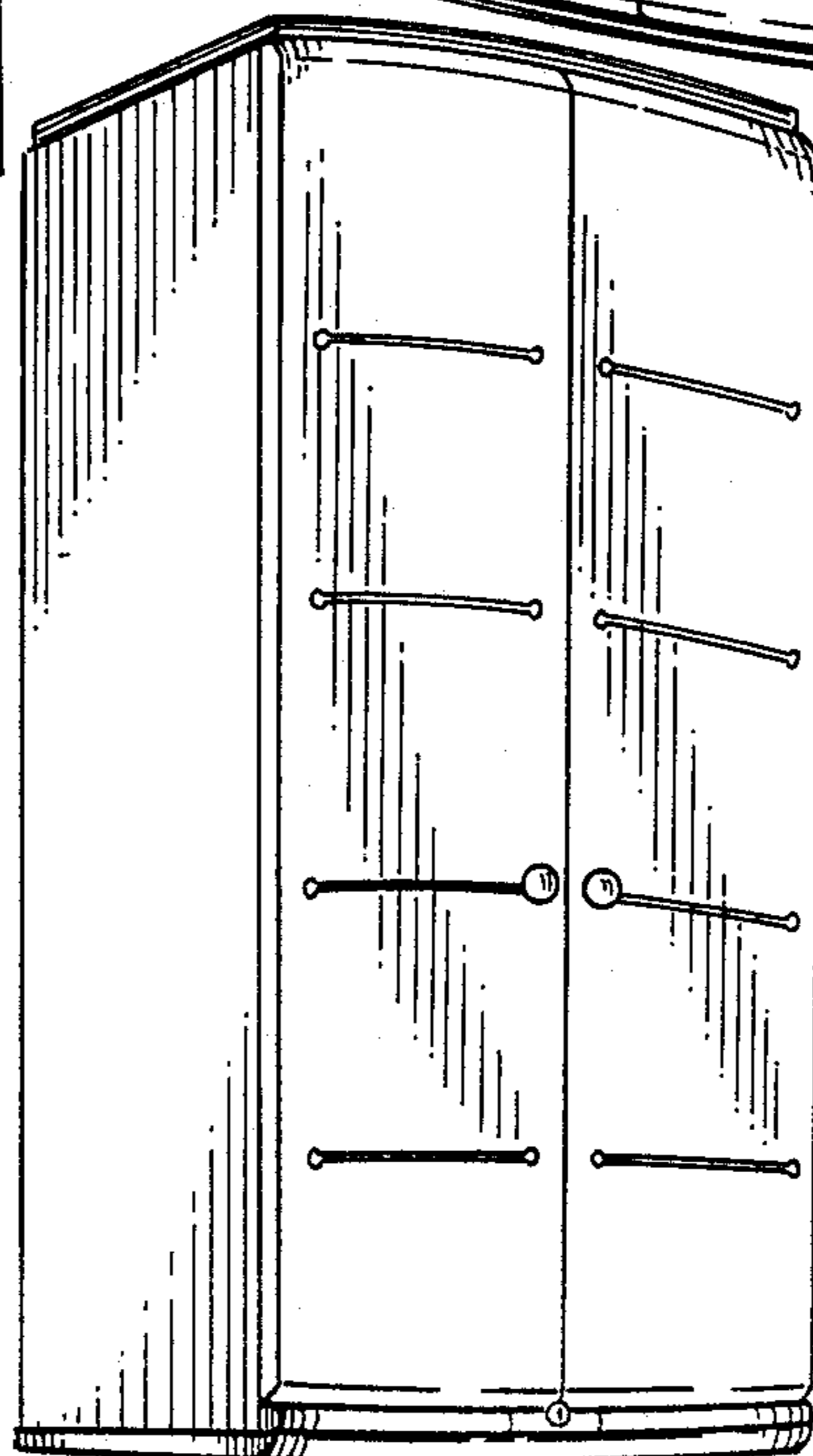
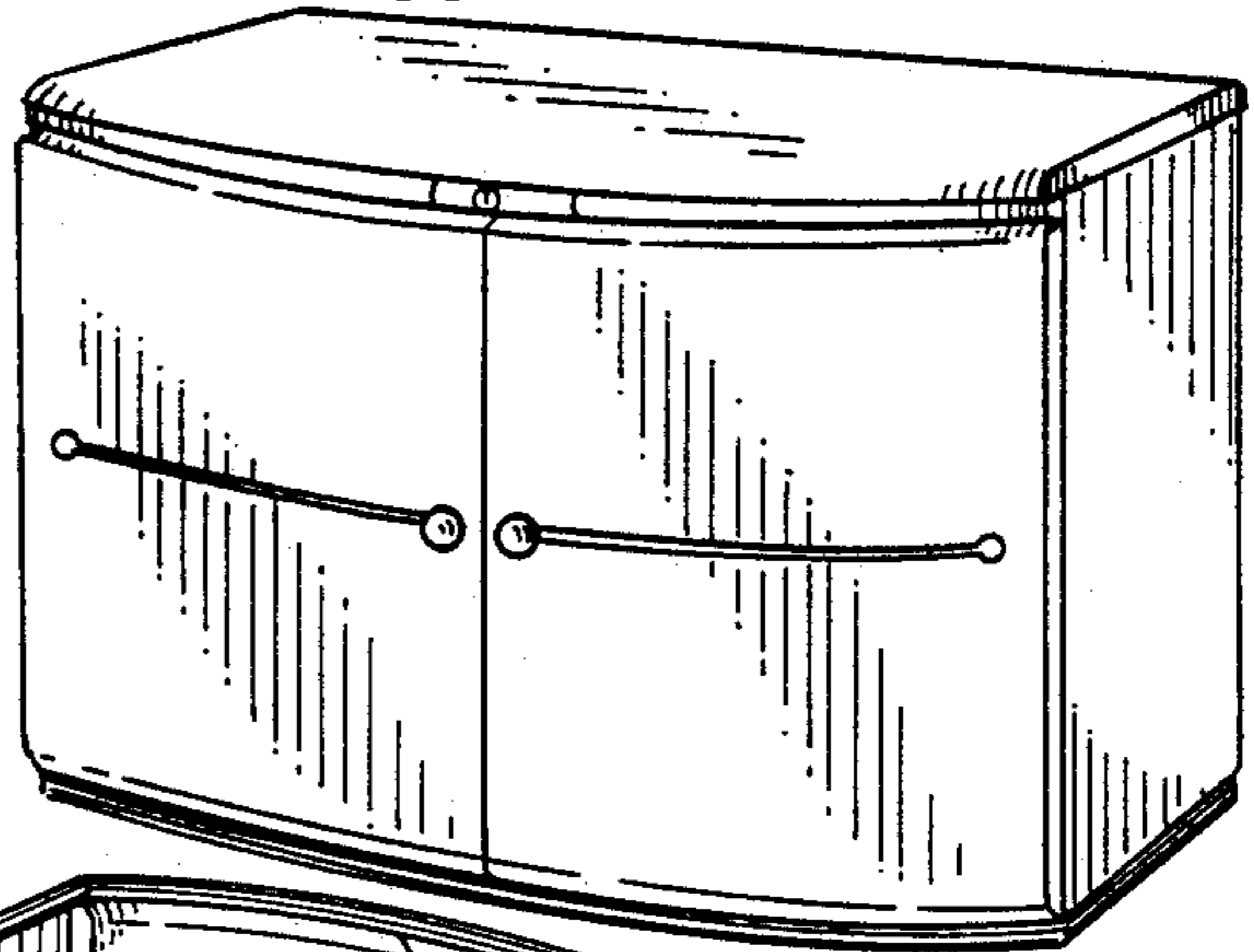
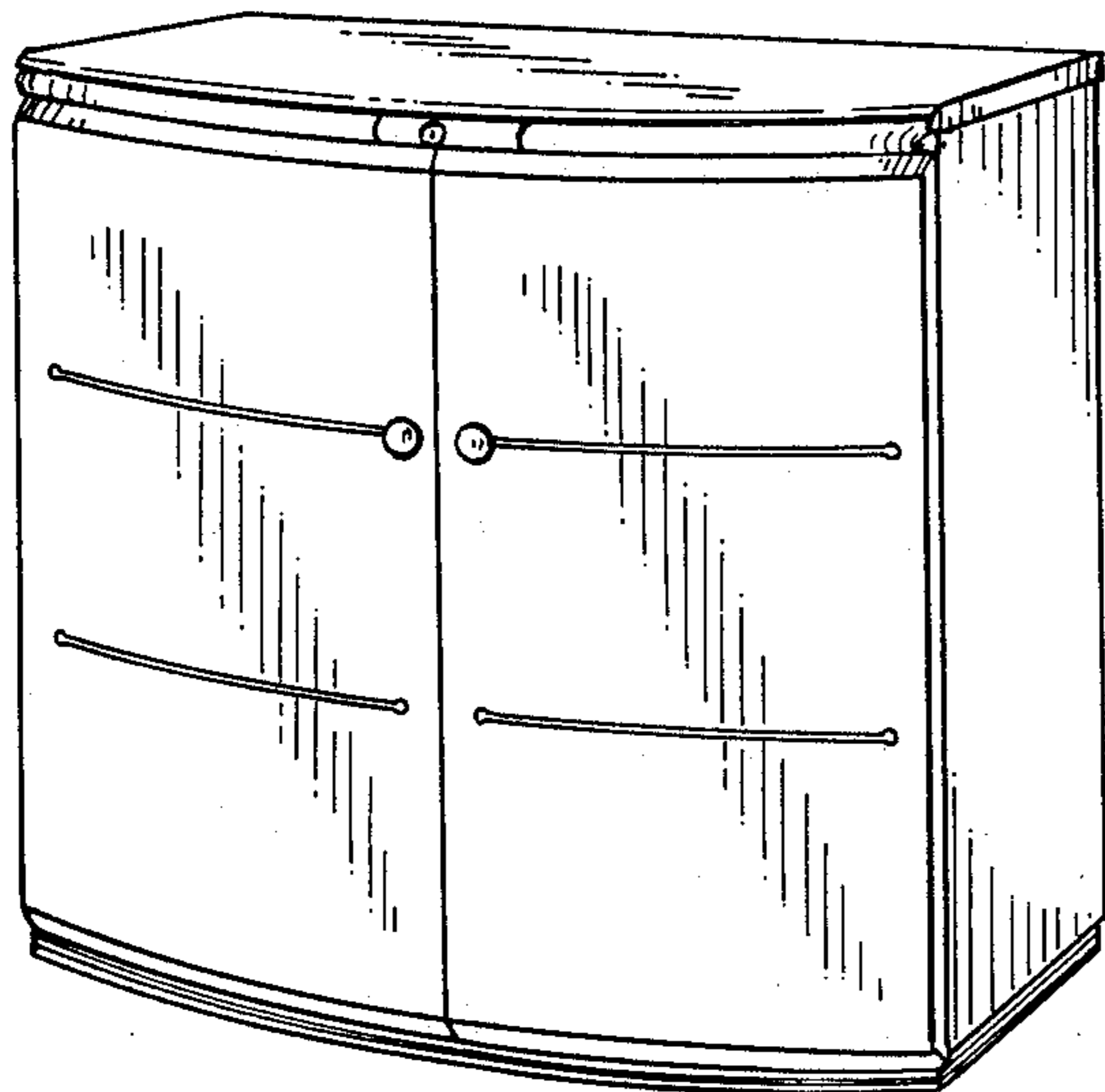

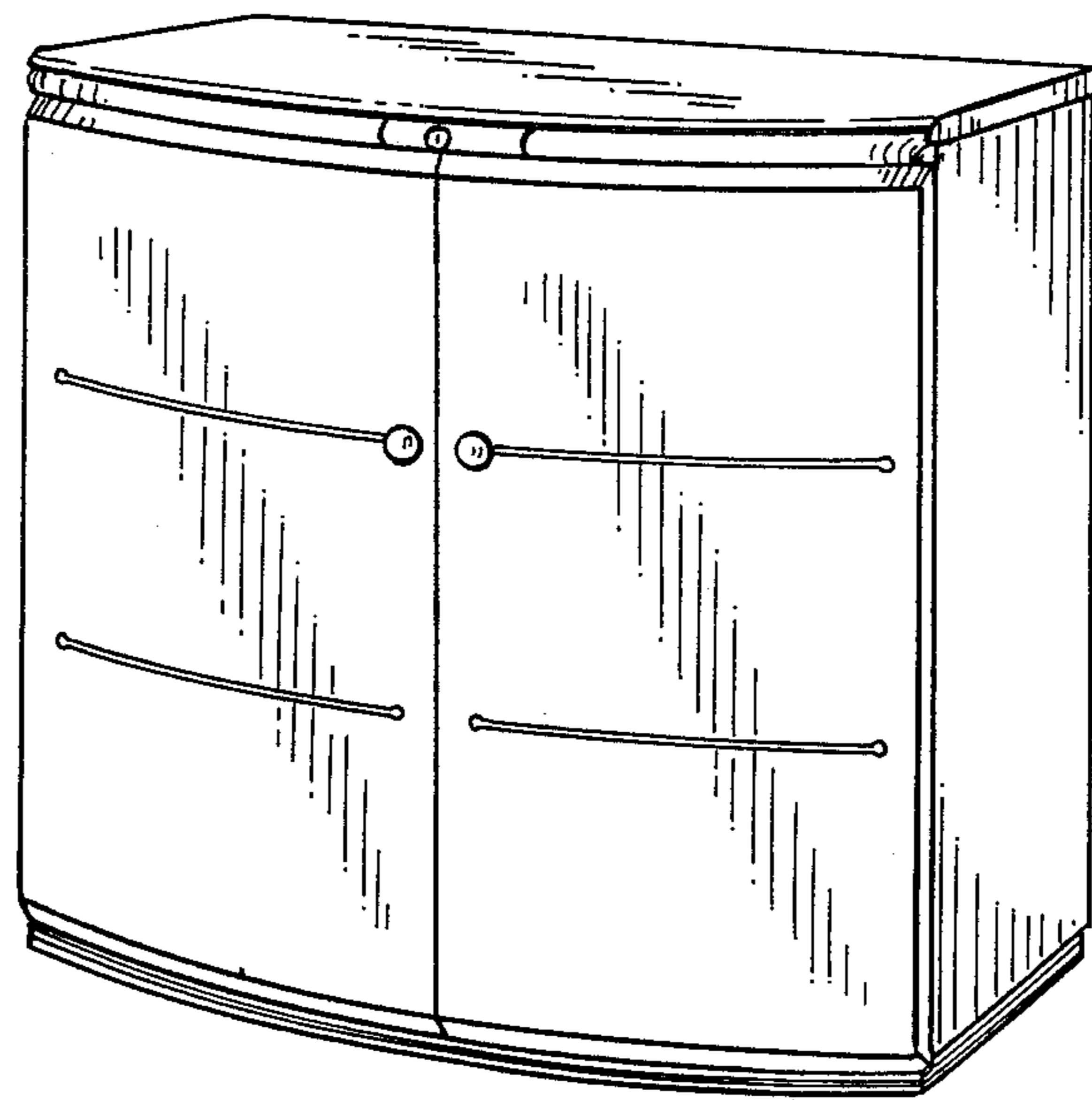

FIG. 1

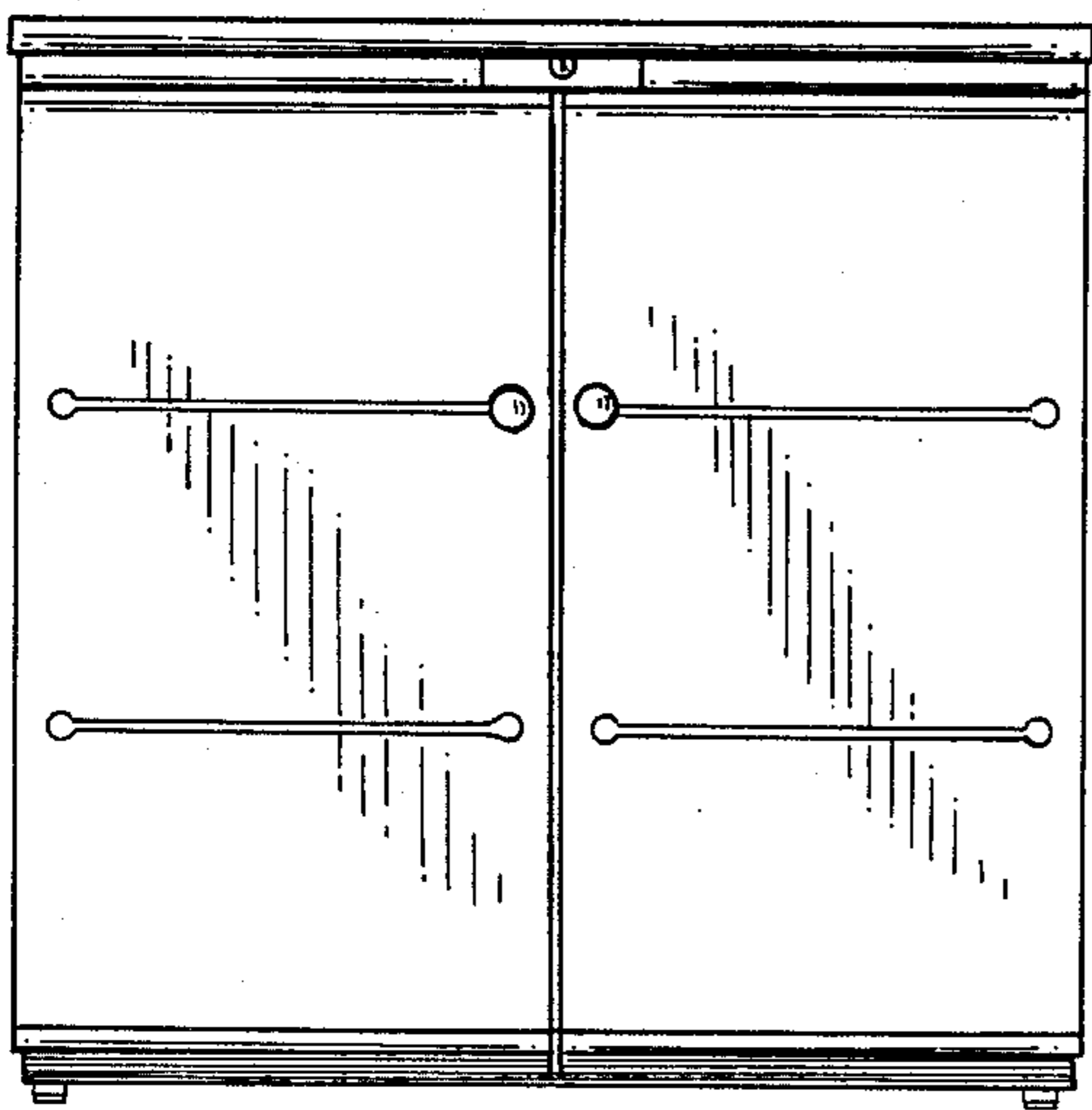

FIG. 2

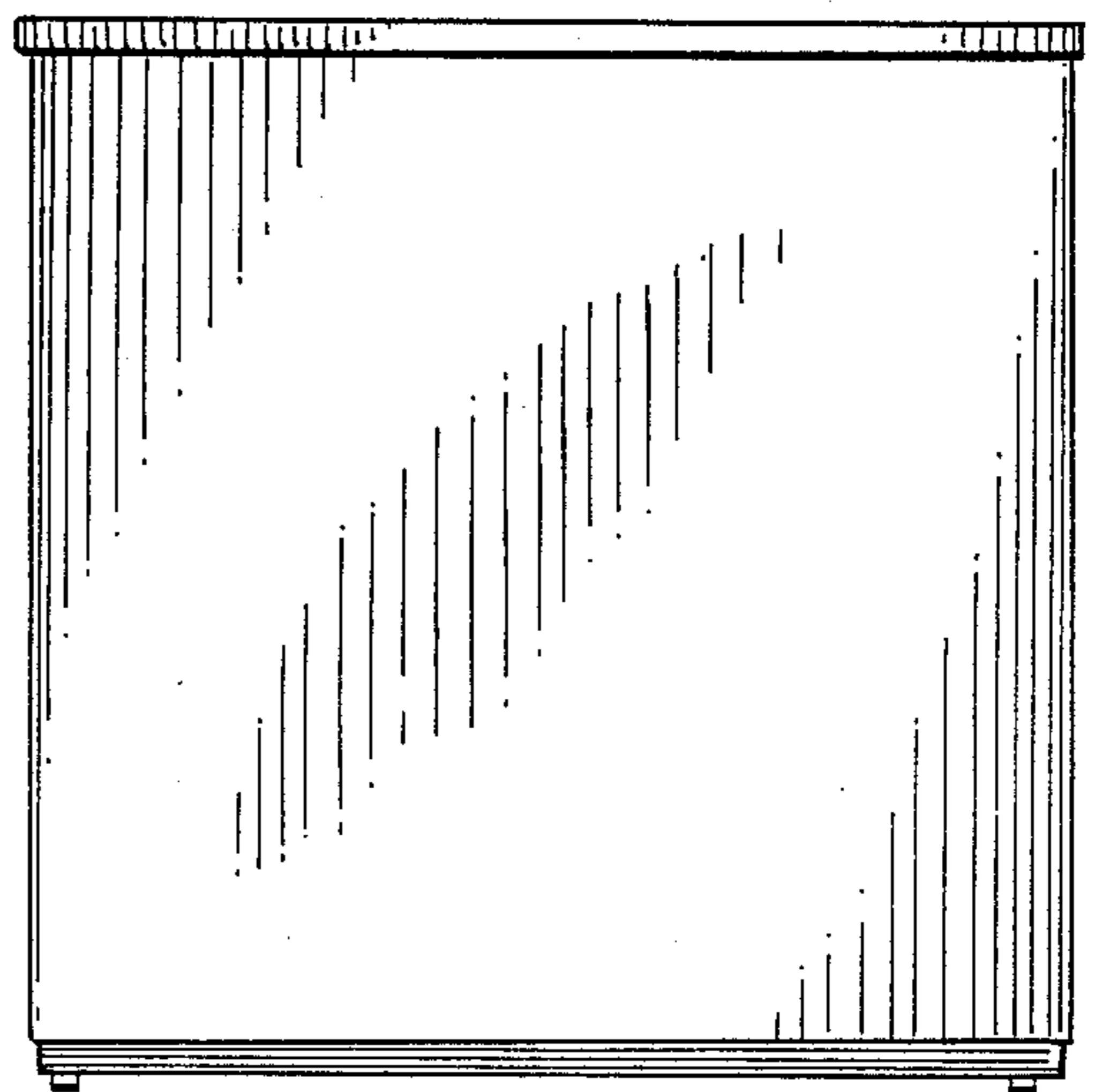

FIG. 3

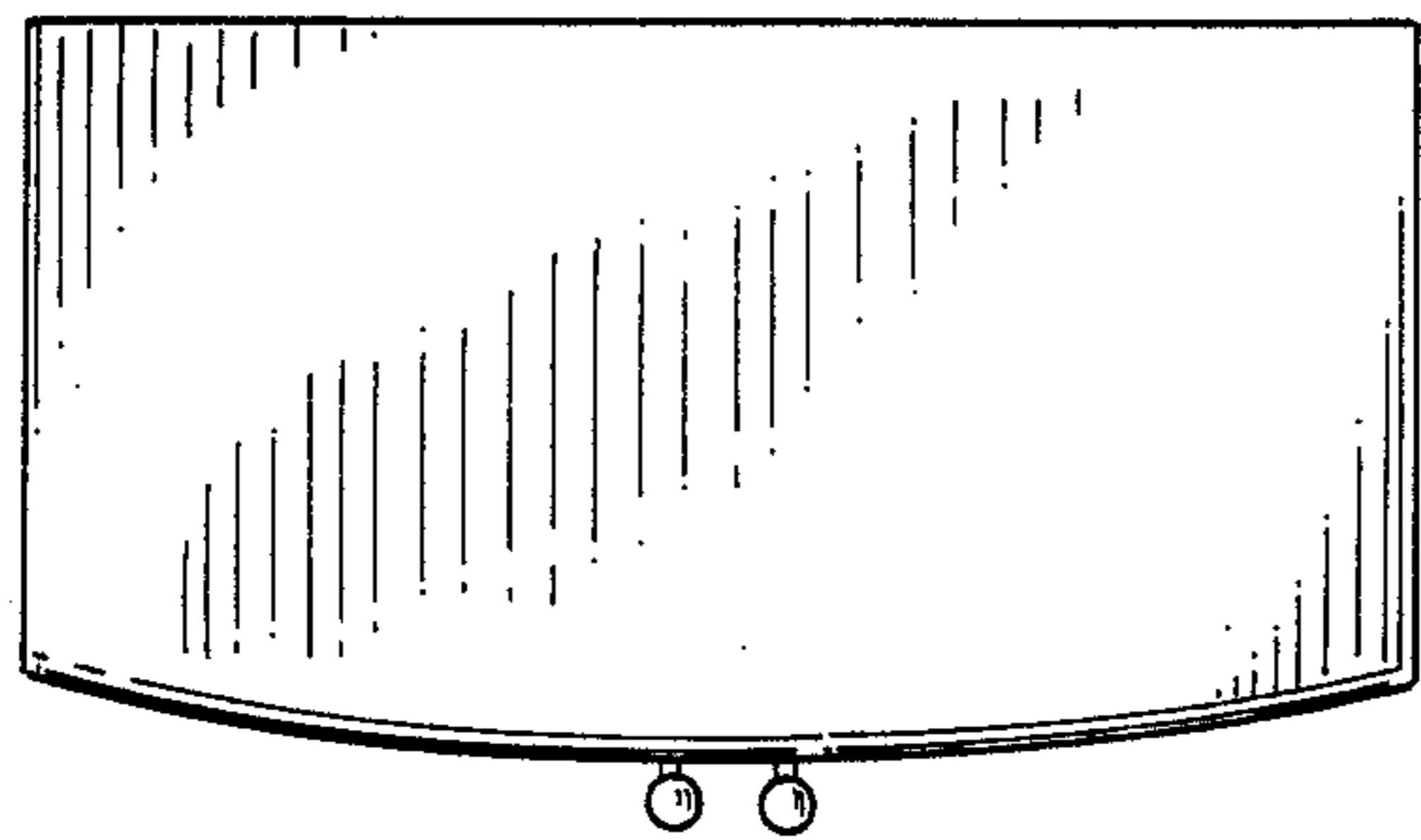

FIG. 4

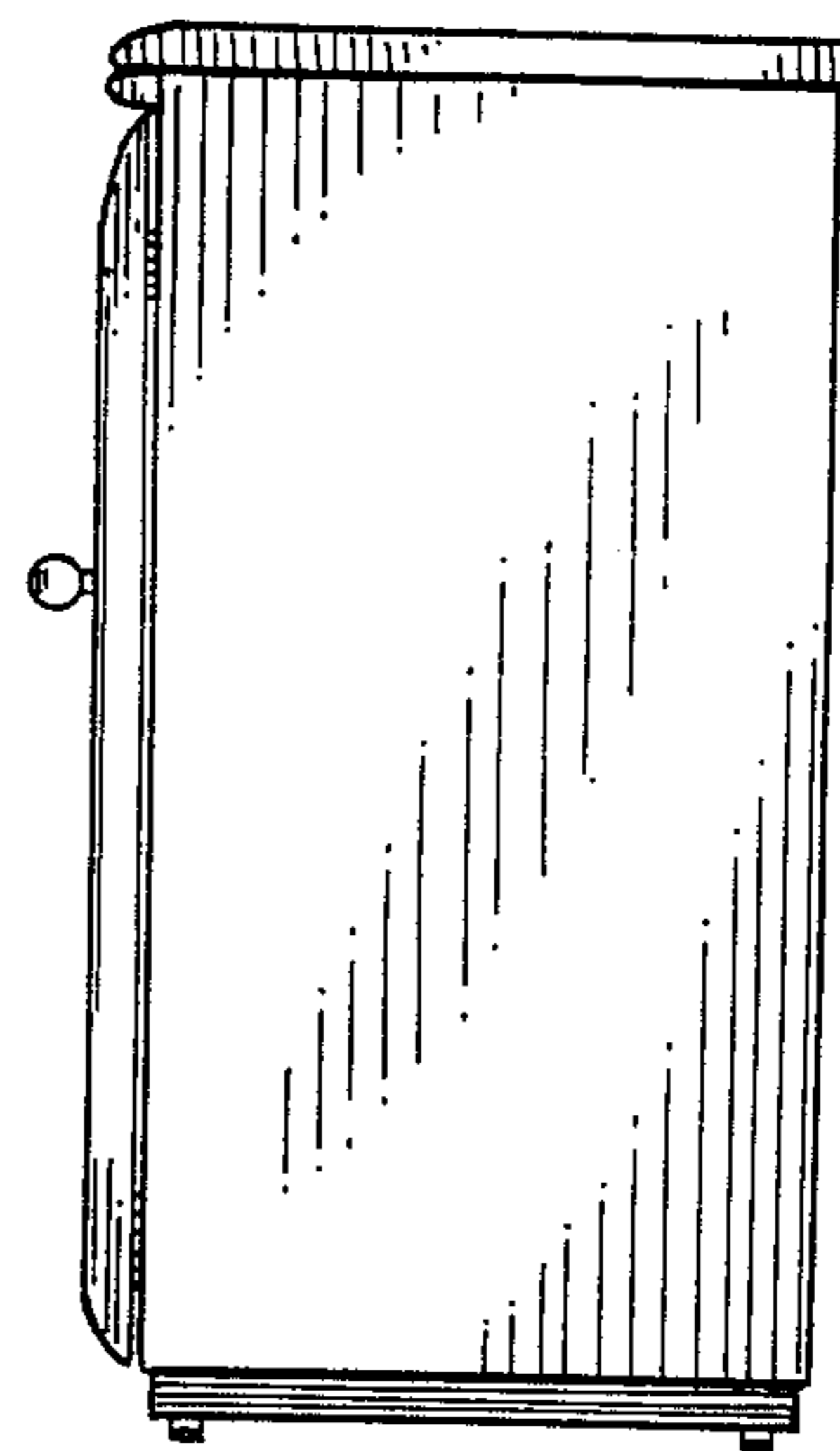

FIG. 5

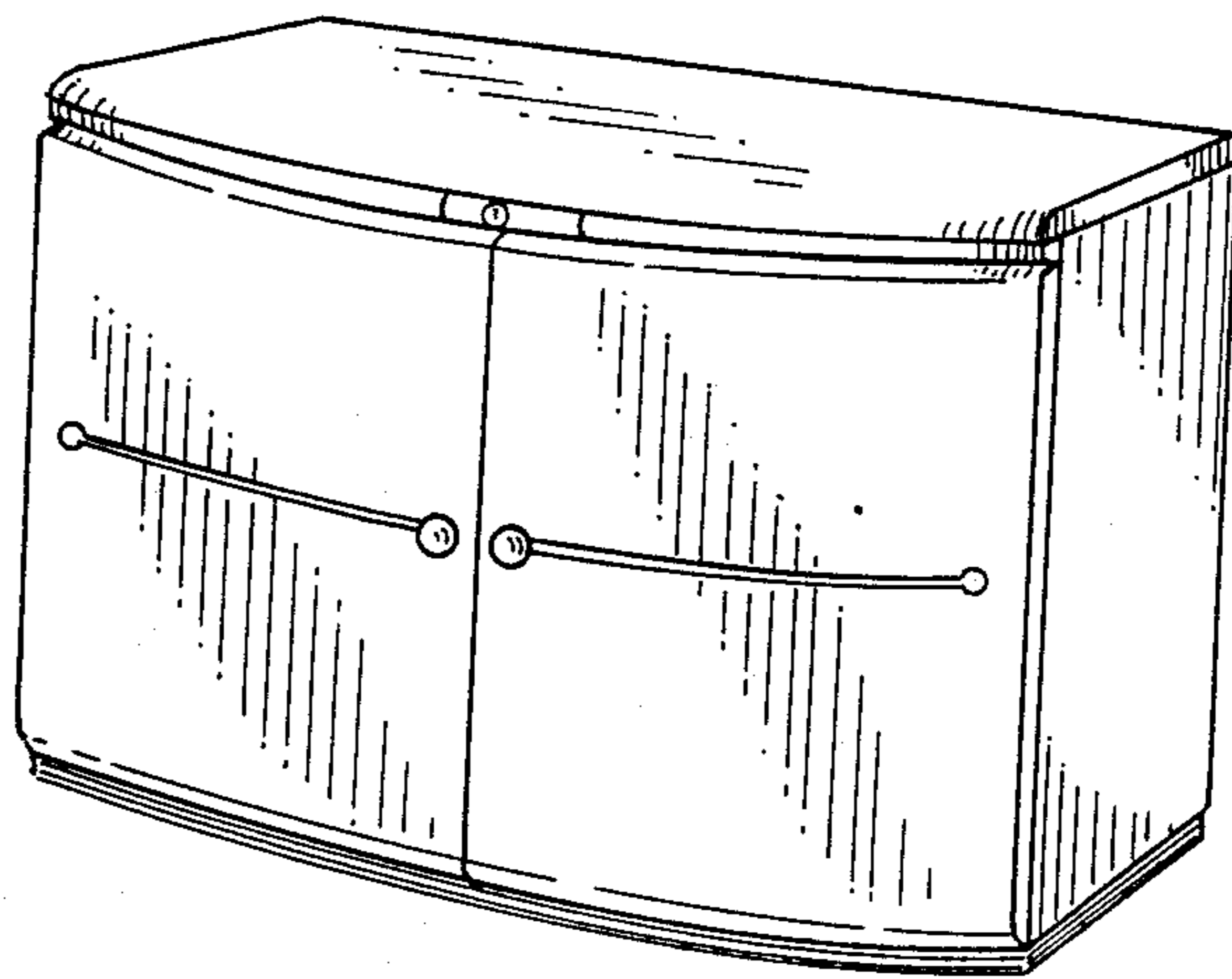

FIG. 6

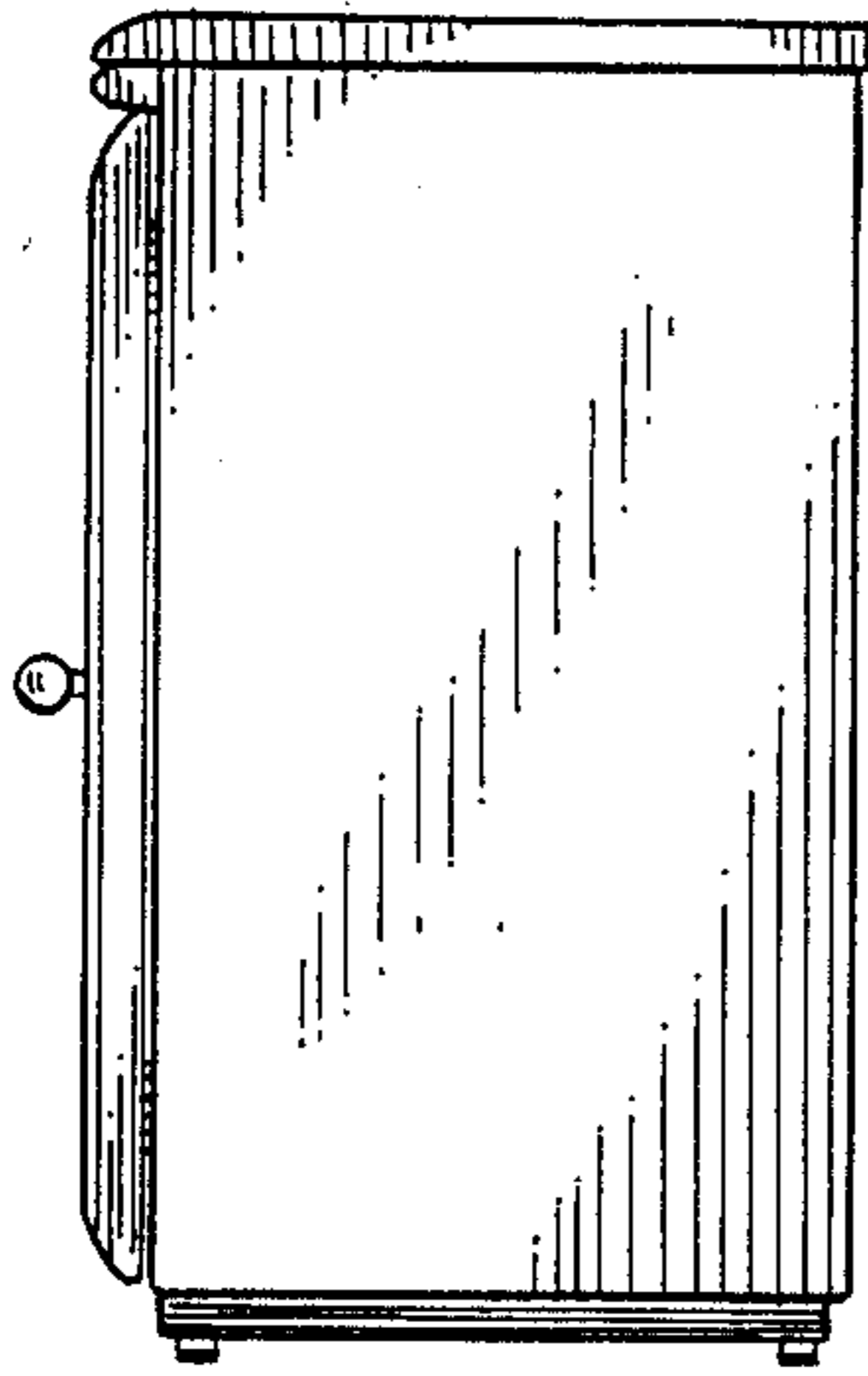

FIG. 7

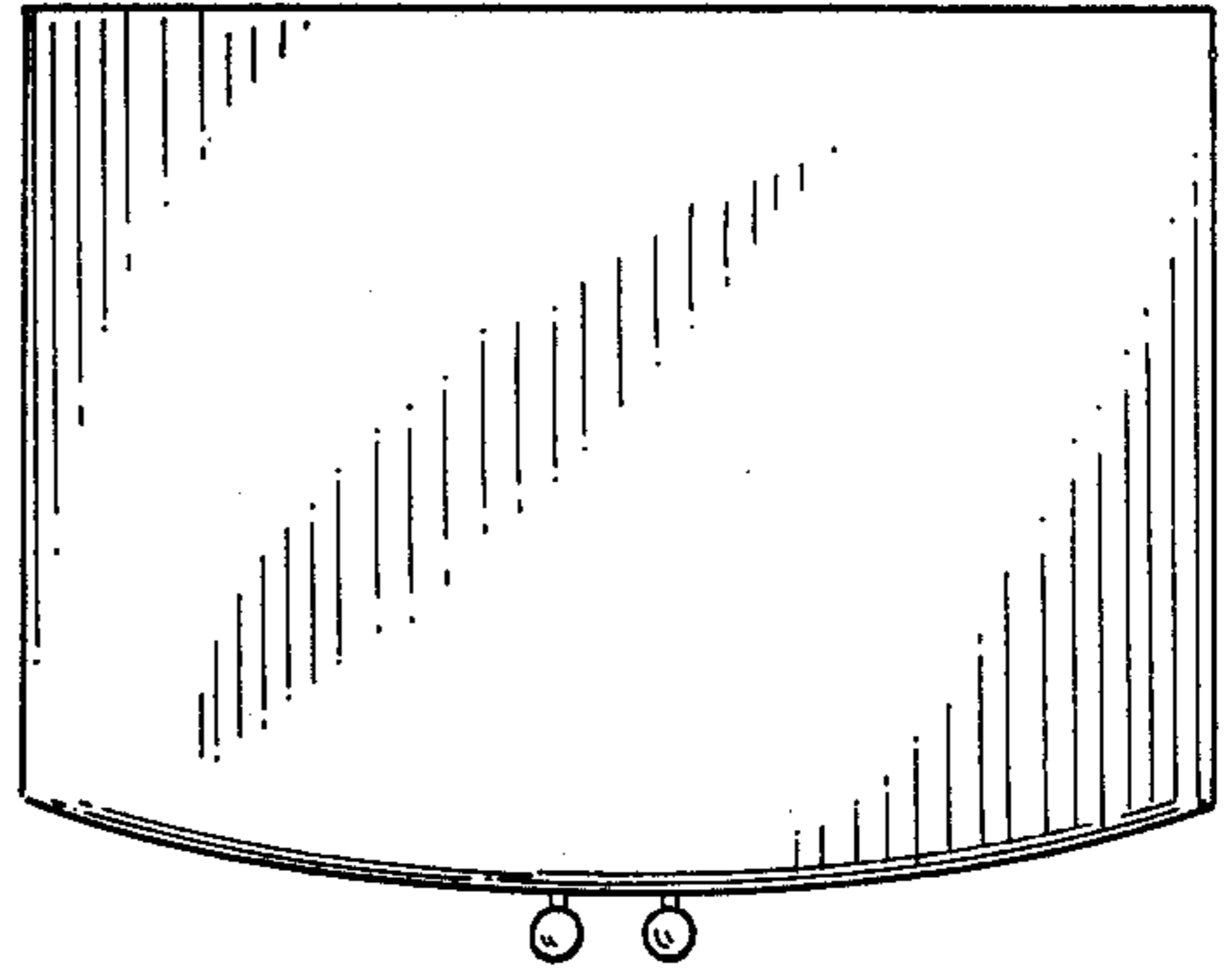

FIG. 8

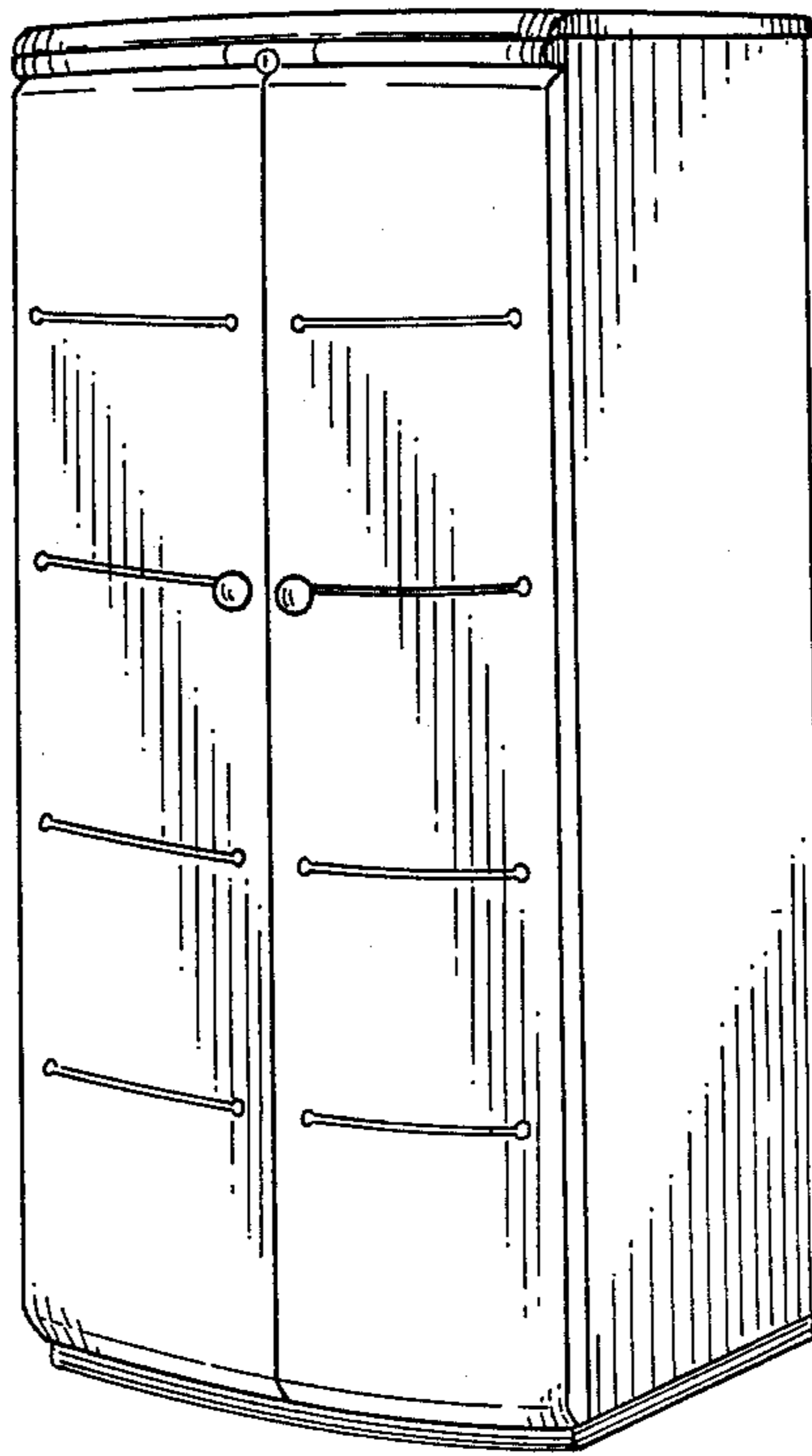

FIG. 9

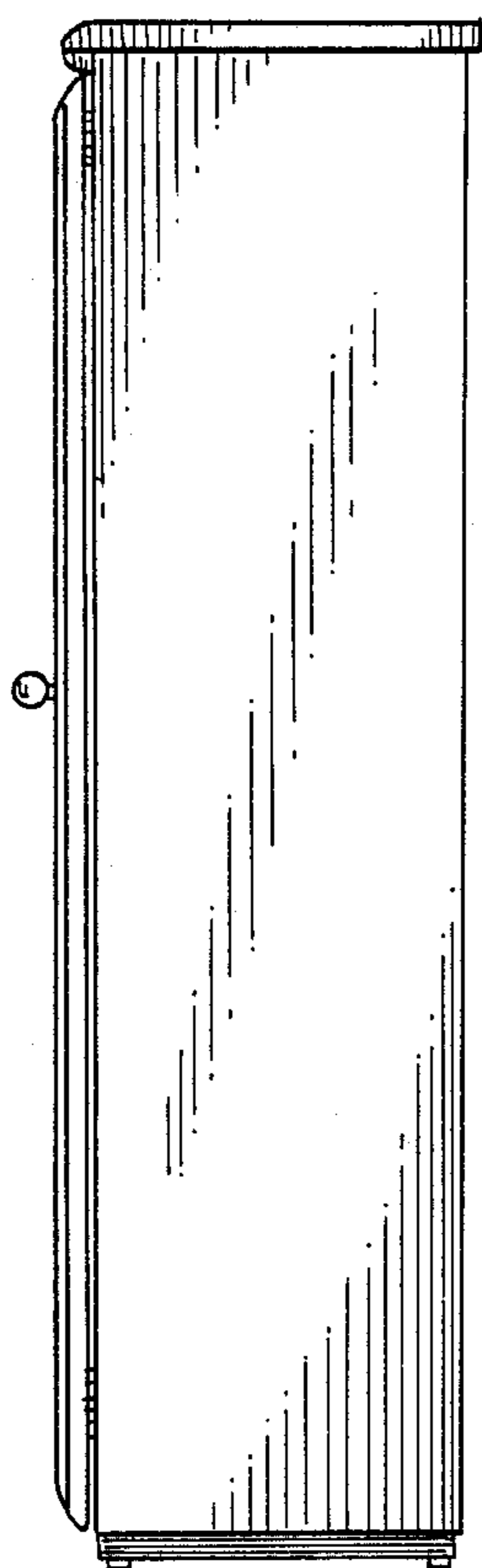

FIG. 10

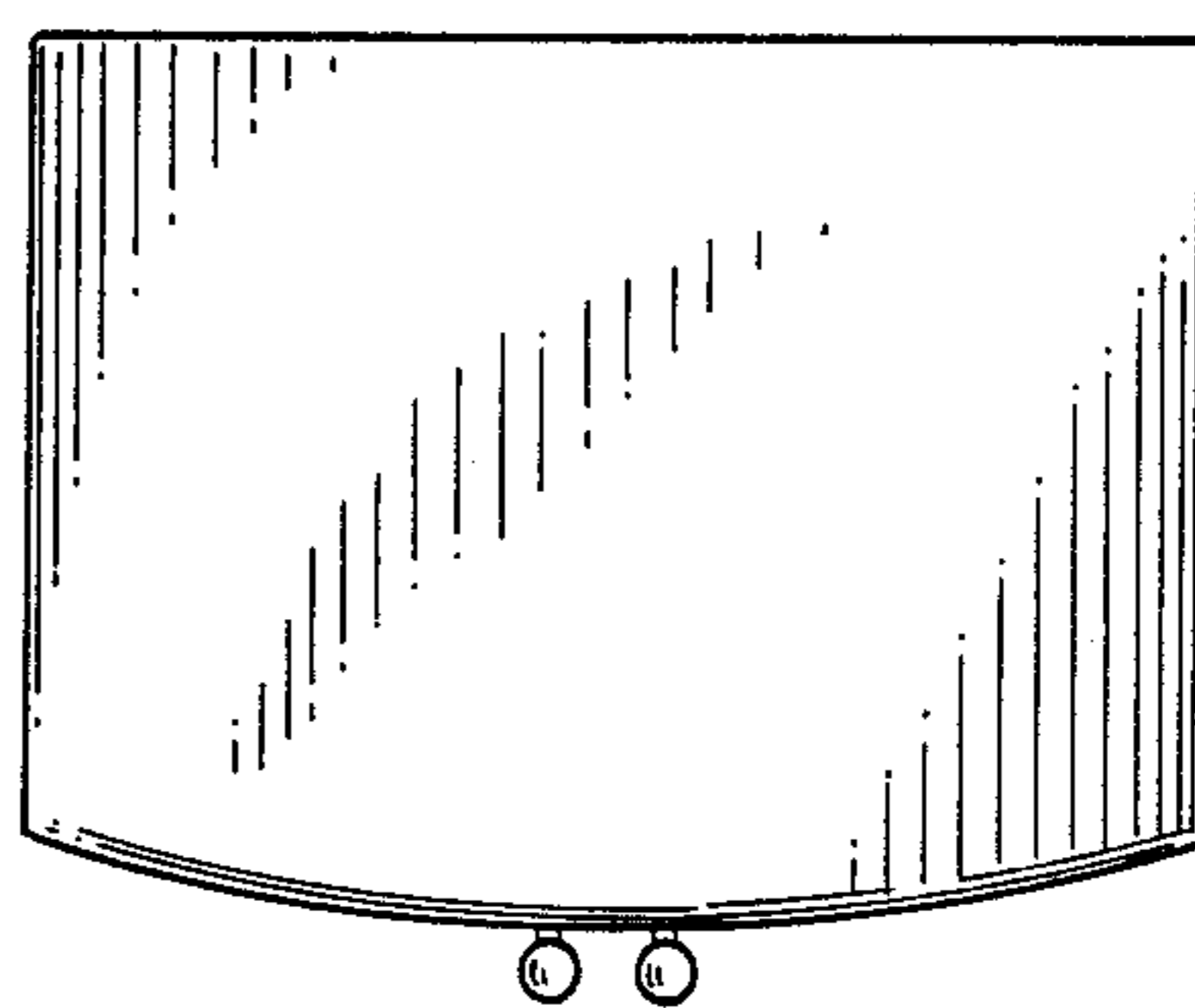

FIG. 11