

[54] TOY ELEPHANT OR THE LIKE

[75] Inventors: Robert F. Bateman, Greenville; Brian L. Newton, Woonsocket; Martin J. Wolff, North Providence, all of R.I.; John R. Nottingham; John W. Spirk, both of Moreland Hills, Ohio

[73] Assignee: Dart Industries Inc., Deerfield, Ill.

[\*\*] Term: 14 Years

[21] Appl. No.: 886,716

[22] Filed: Jul. 16, 1986

[52] U.S. Cl. .... D21/162

[58] Field of Search ..... D21/162, 154, 148, 149; 446/71-75, 97, 101, 268, 385

[56] References Cited

U.S. PATENT DOCUMENTS

D. 169,419	4/1953	Campbell	.....	D21/162
1,026,861	5/1912	Haskell	.....	446/388
2,482,334	9/1949	Fernald	.....	D21/162

FOREIGN PATENT DOCUMENTS

543223	9/1959	Belgium	.....	446/385
451100	9/1927	Fed. Rep. of Germany	.....	446/73
963263	7/1950	France	.....	446/268
1002115	3/1952	France	.....	446/99
564361	7/1975	Switzerland	.....	446/73
599468	9/1946	United Kingdom	.....	446/99

Primary Examiner—Melvin B. Feifer  
Attorney, Agent, or Firm—John A. Doninger

[57] CLAIM

The ornamental design for a toy elephant or the like, as shown.

DESCRIPTION

FIG. 1 is a top perspective view of the toy elephant or the like showing our new design;  
FIG. 2 is a top plan view thereof;  
FIG. 3 is a side elevational view of the near side of FIG. 1;  
FIG. 4 is a side elevational view of the far side of FIG. 1;  
FIG. 5 is a head end elevational view thereof;  
FIG. 6 is a rear end elevational view thereof;  
FIG. 7 is a bottom plan view thereof;  
FIG. 8 is an exploded perspective view of FIG. 1.

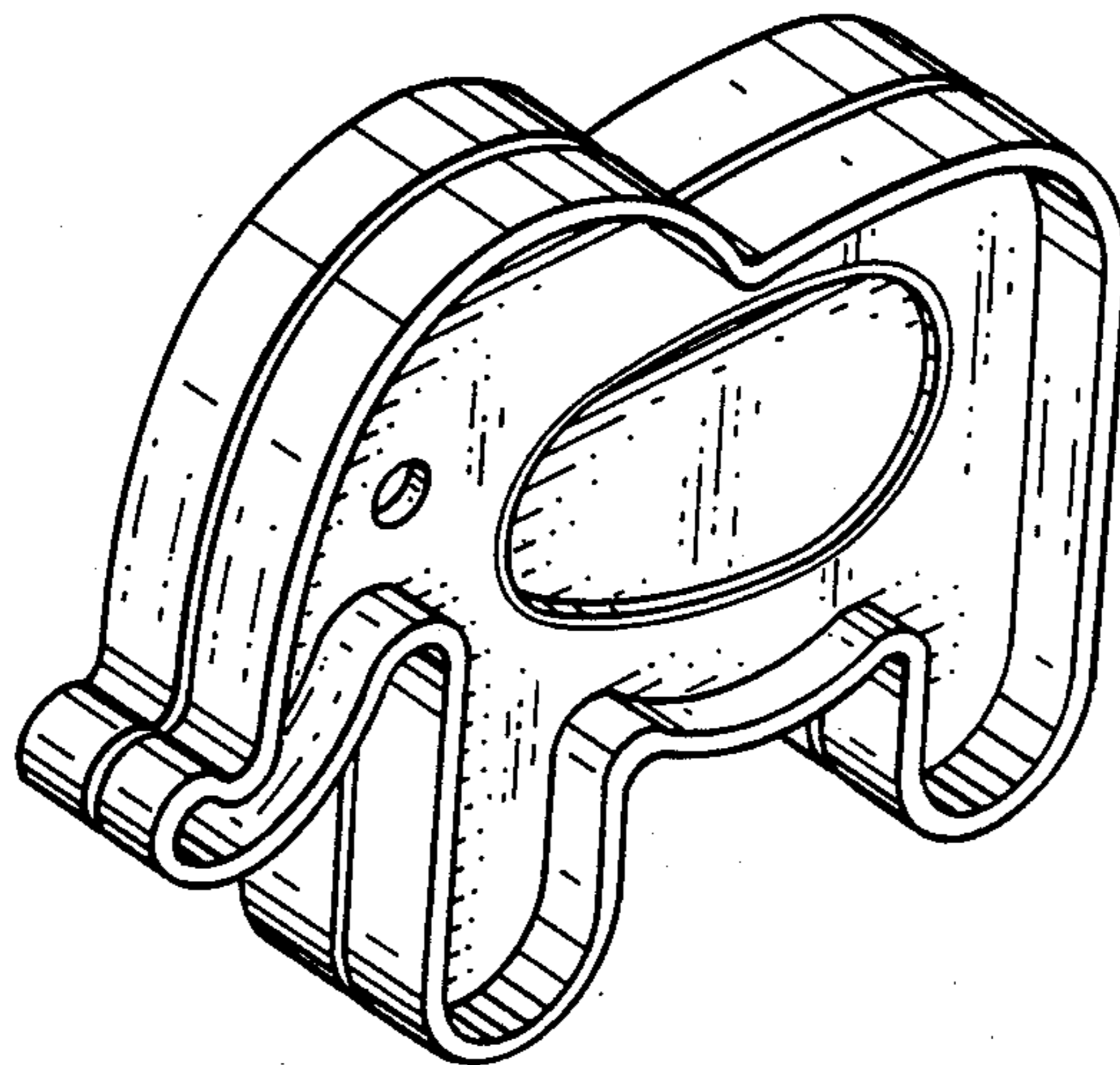

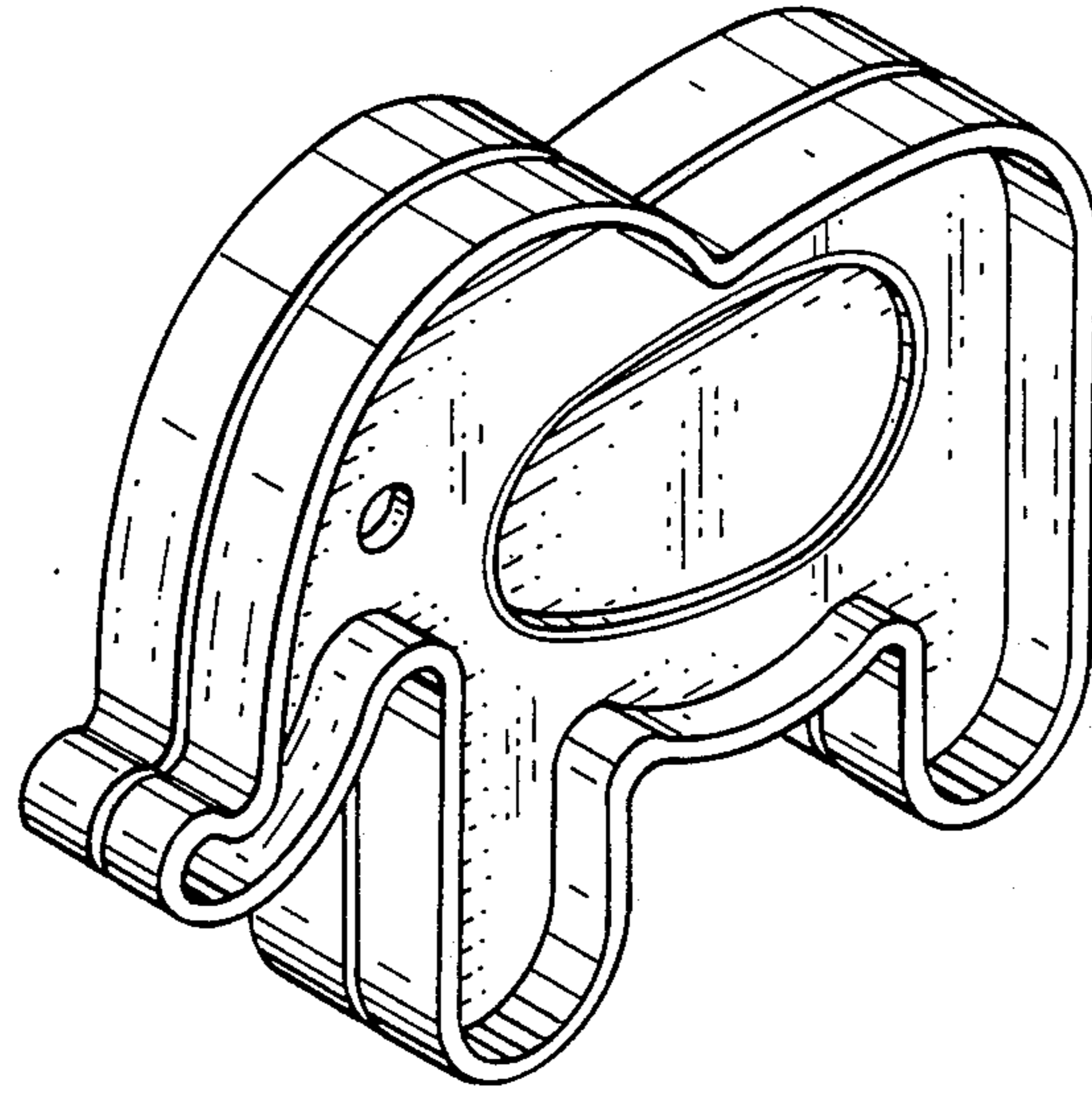

FIG. 1

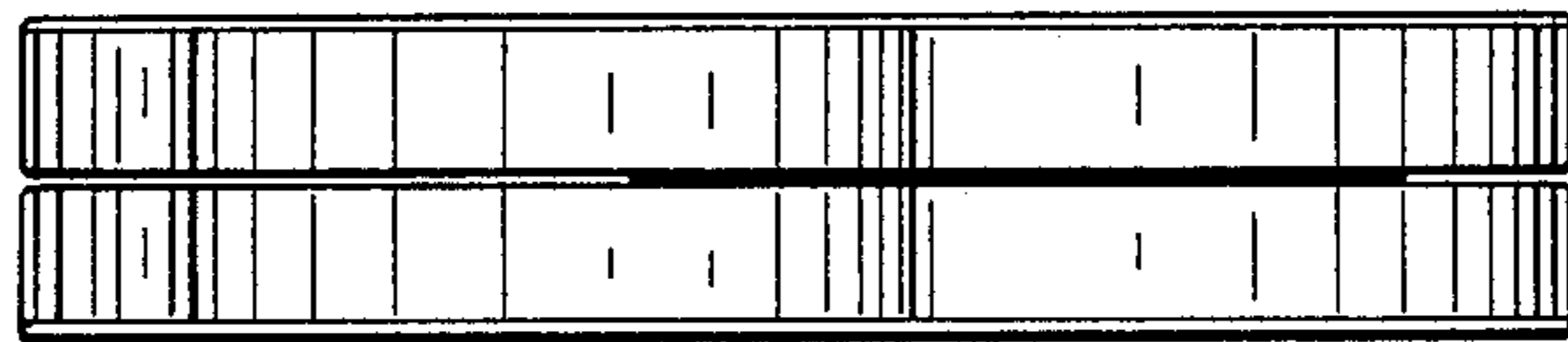

FIG. 2

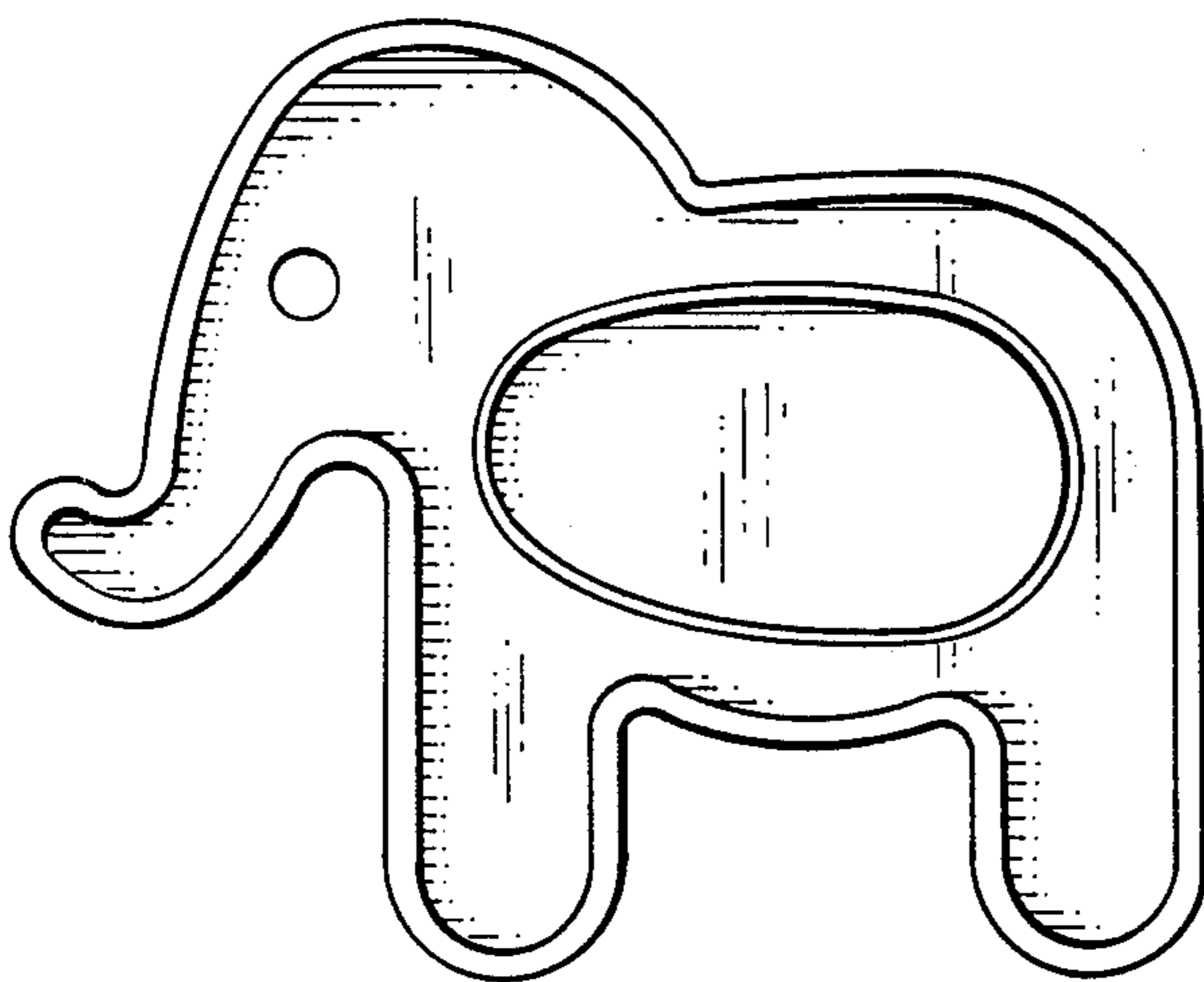

FIG. 3

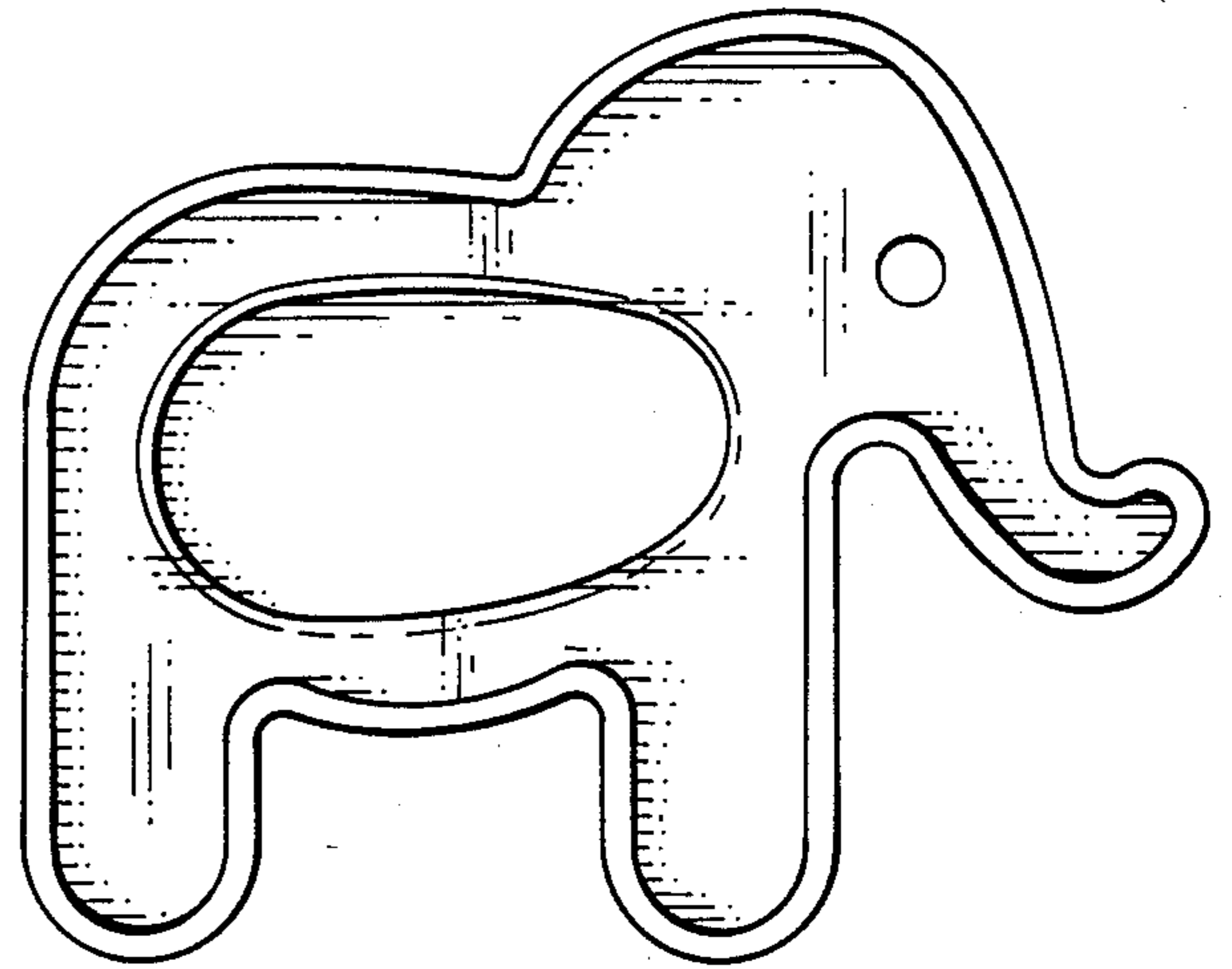

FIG. 4

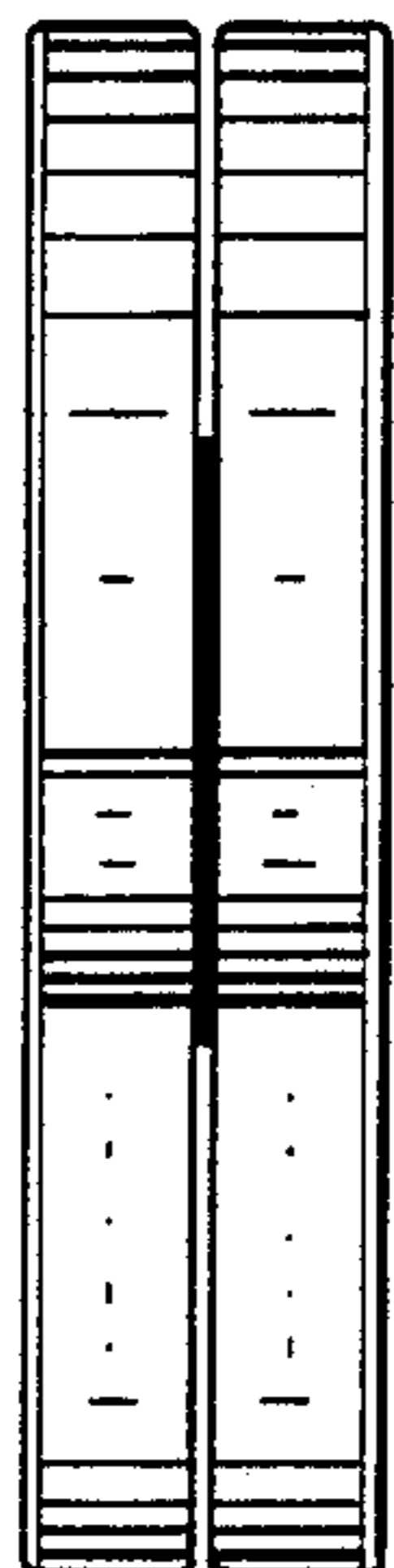

FIG. 5

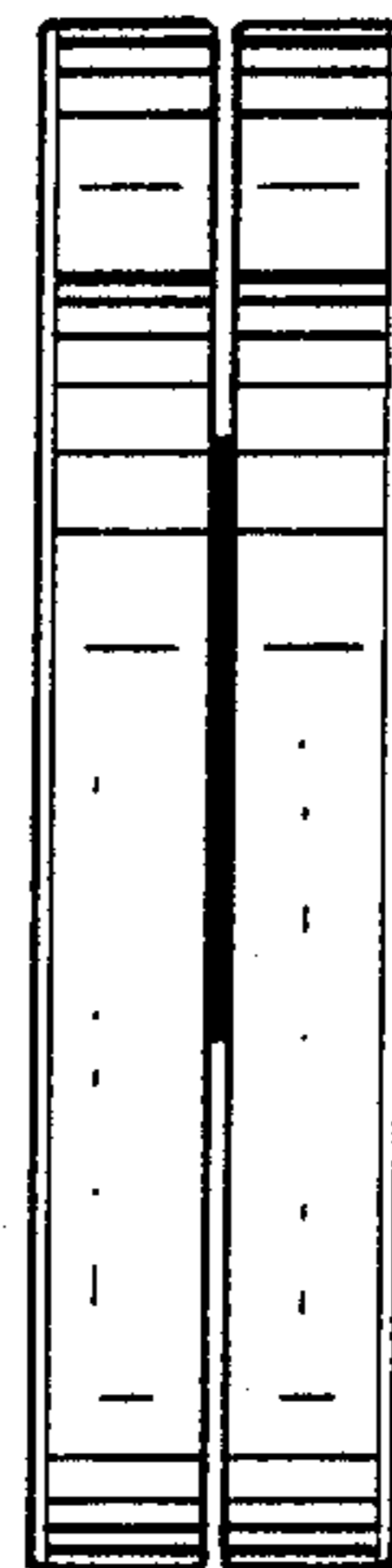

FIG. 6



FIG. 7

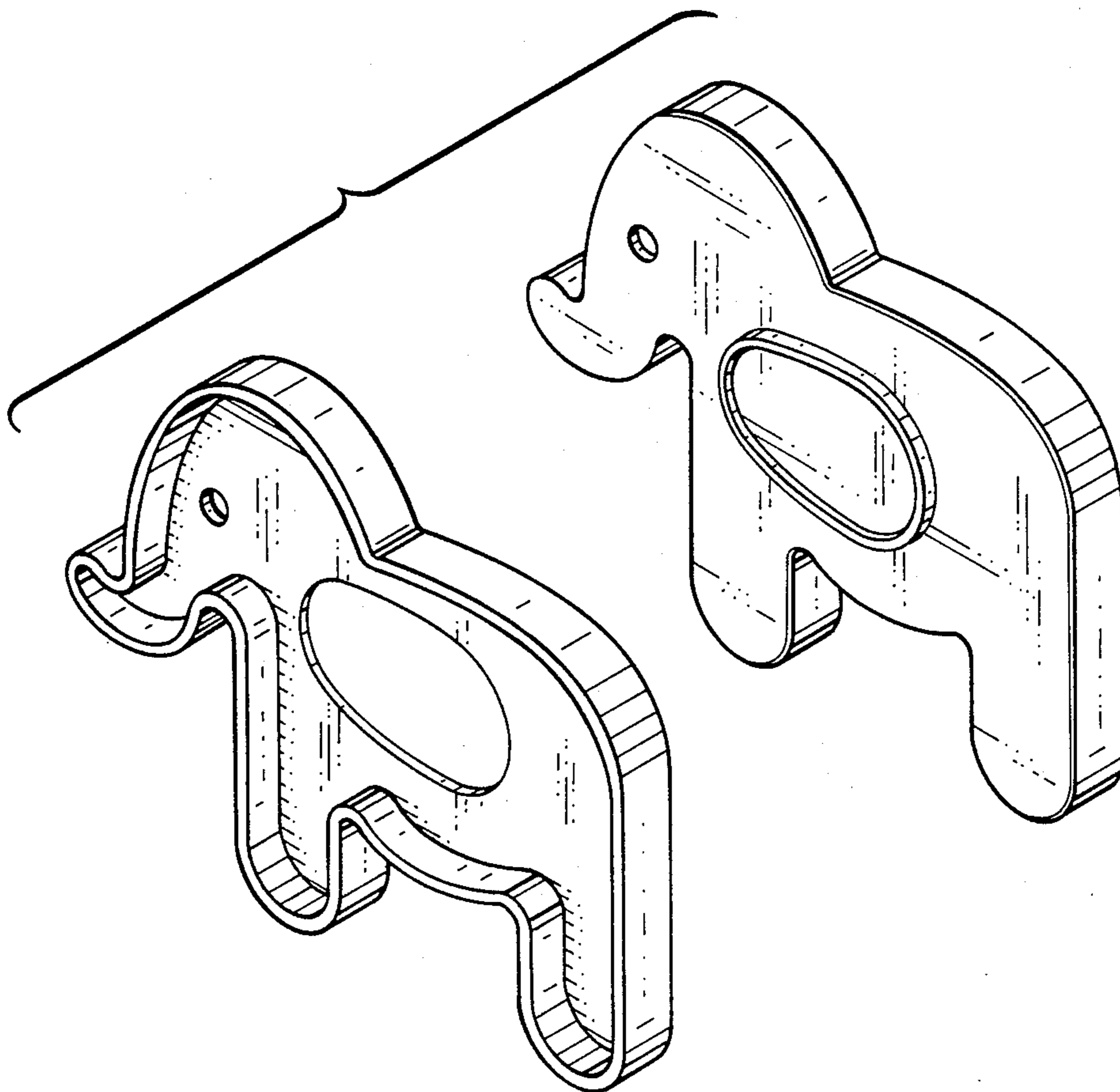

FIG. 8