

[54] SIMULATIVE TOY PENCIL SHARPENER

[75] Inventor: Hiroshi Ukisu, Matsudo, Japan

[73] Assignee: Epoch Company, Ltd., Tokyo, Japan

[**] Term: 14 Years

[21] Appl. No.: 131,547

[22] Filed: Dec. 11, 1987

[52] U.S. Cl. D21/59; D19/73

[58] Field of Search D21/59, 109, 120; D3/20, 21; D9/307, 332, 333, 414, 420; 446/71, 73, 75, 80, 475, 483, 489, 491; 424/159, 160, 403; 273/157 R; D19/73

[56] References Cited

U.S. PATENT DOCUMENTS

- D. 10,886 10/1878 Weller D9/333
- D. 97,522 11/1935 Campbell D19/73
- D. 112,274 11/1938 Blunt D9/333

- D. 220,409 4/1971 Lee et al. D19/85
- D. 251,977 5/1979 Levenberger et al. D19/73
- 4,666,042 5/1987 Dlott et al. 446/73

Primary Examiner—Charles A. Rademaker
Attorney, Agent, or Firm—Staas & Halsey

[57] CLAIM

The ornamental design for a simulative toy pencil sharpener, as shown and described.

DESCRIPTION

FIG. 1 is a front elevational view of a simulative toy pencil sharpener showing our new design;
 FIG. 2 is a right side elevational view thereof;
 FIG. 3 is a top plan view thereof;
 FIG. 4 is a bottom plan view thereof;
 FIG. 5 is a perspective view thereof with the front cover lifted; and
 FIG. 6 is a perspective view thereof with the rear cover lifted.

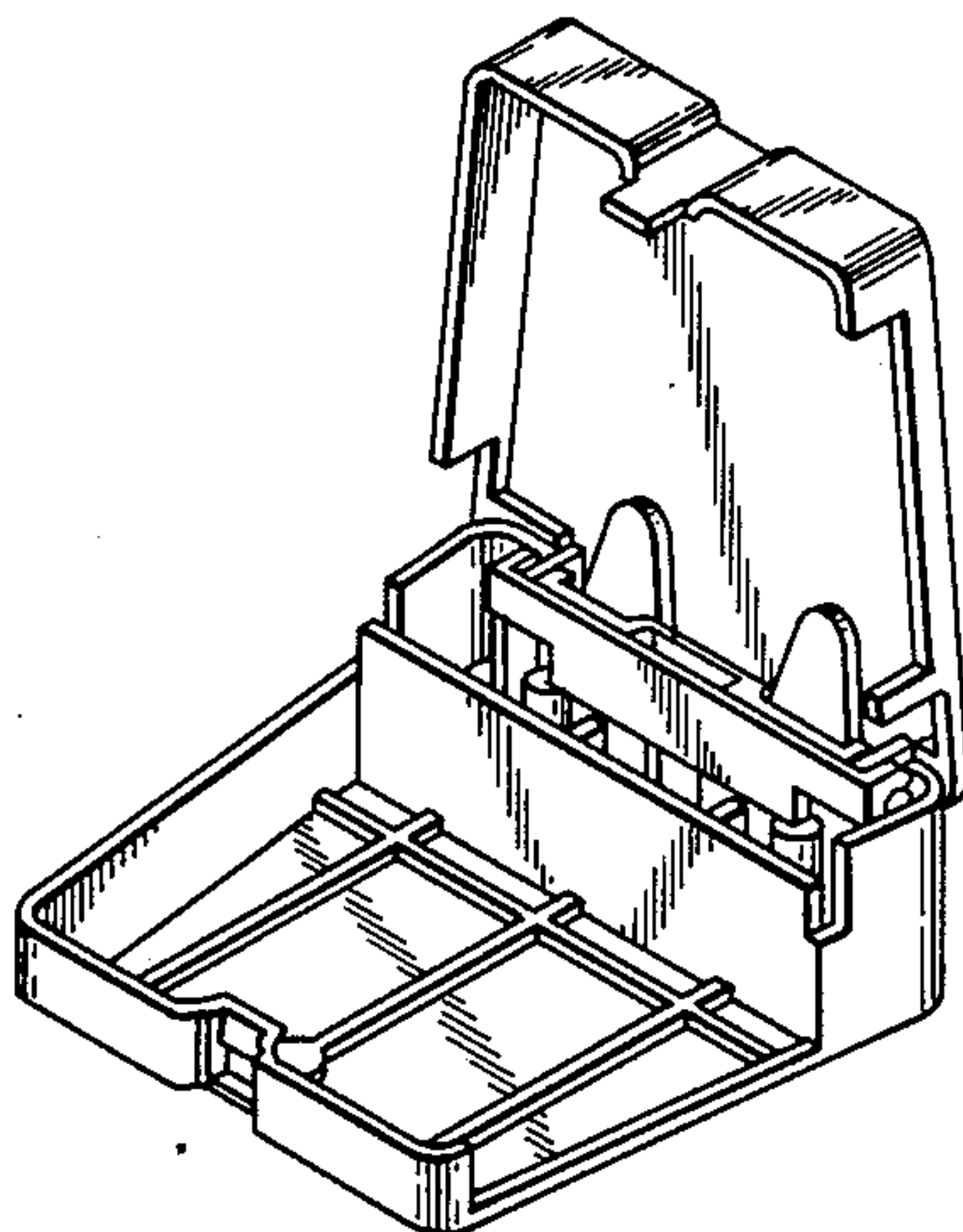
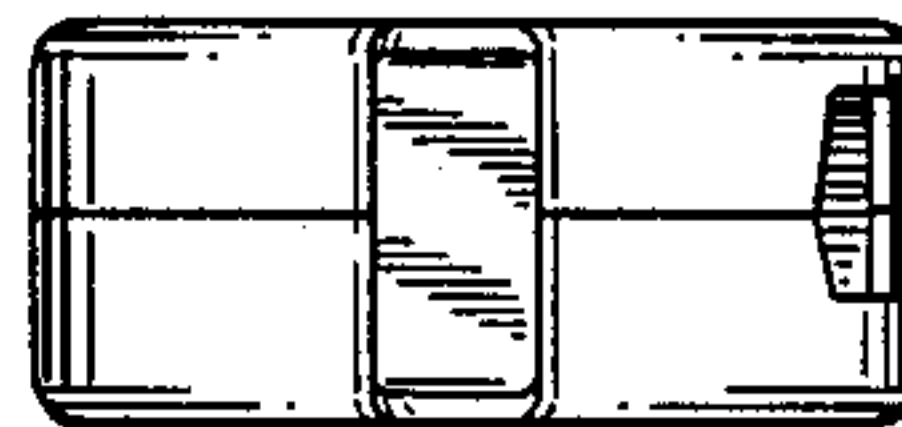

FIG. 1

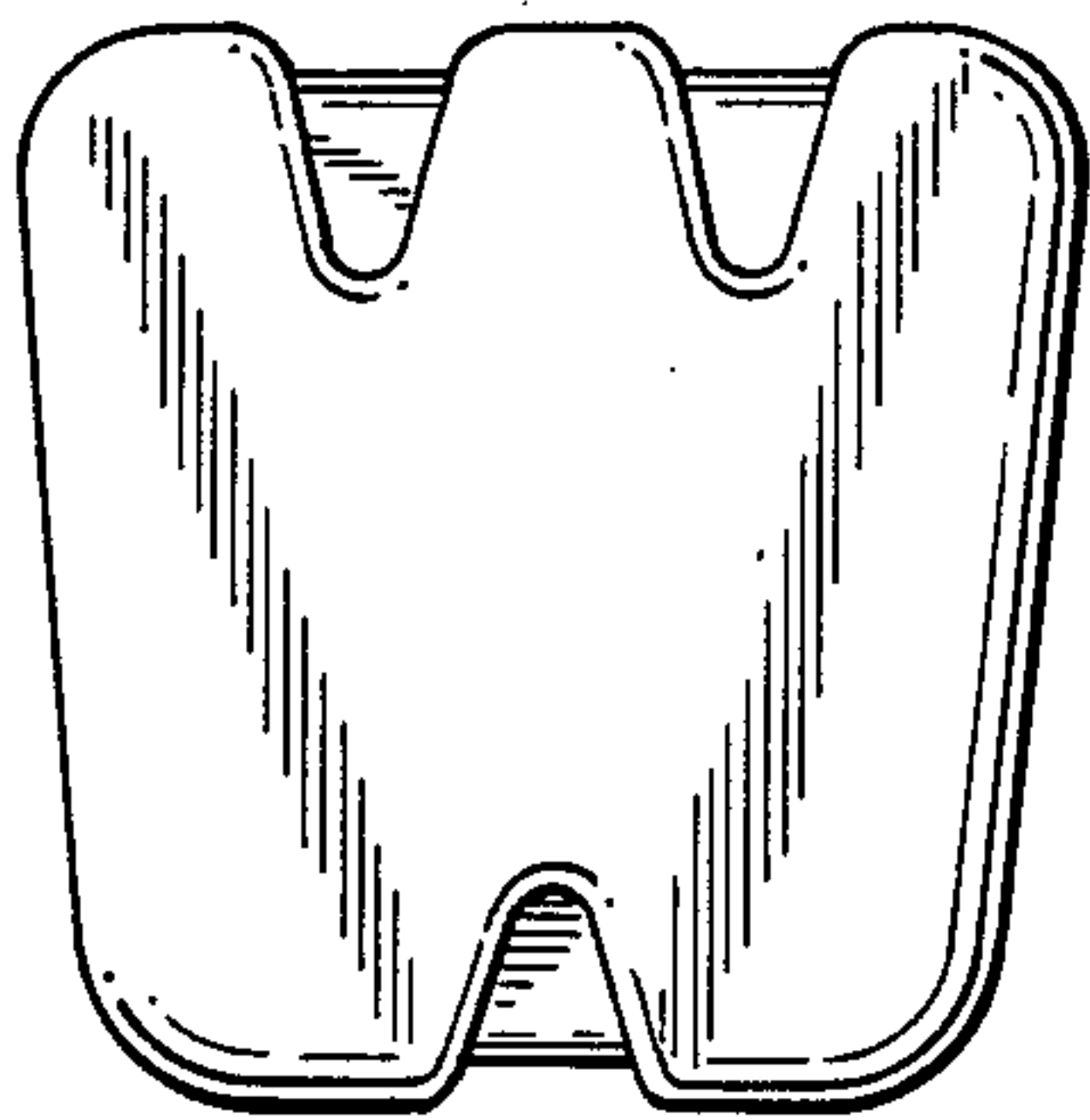

FIG. 2

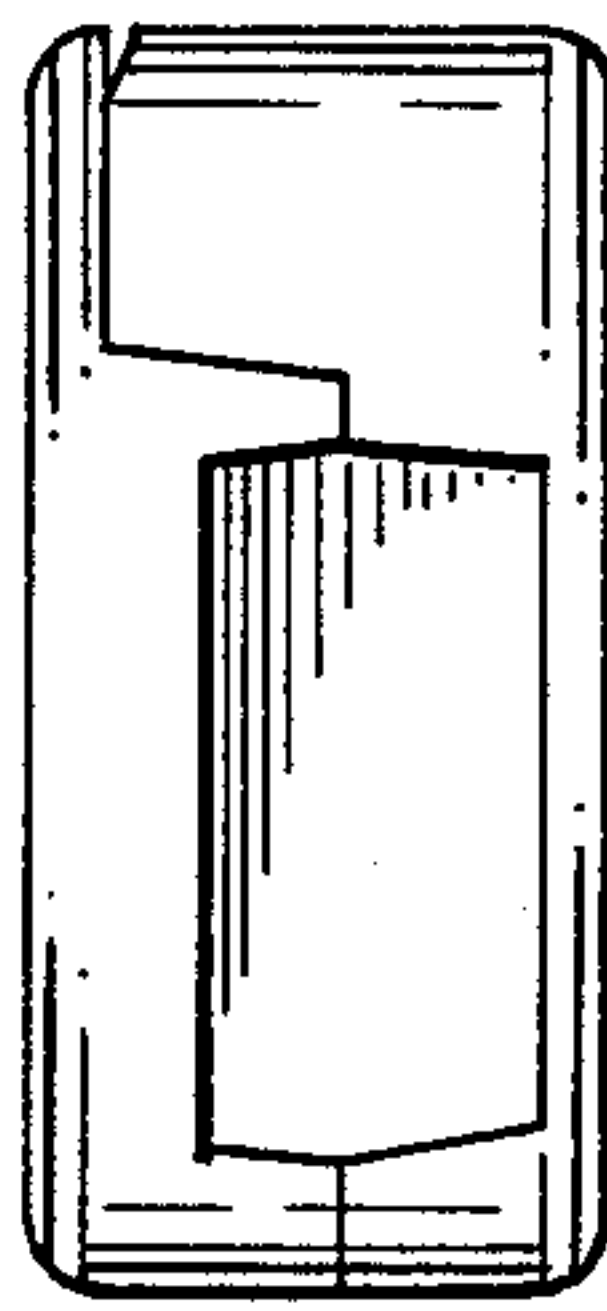

FIG. 3

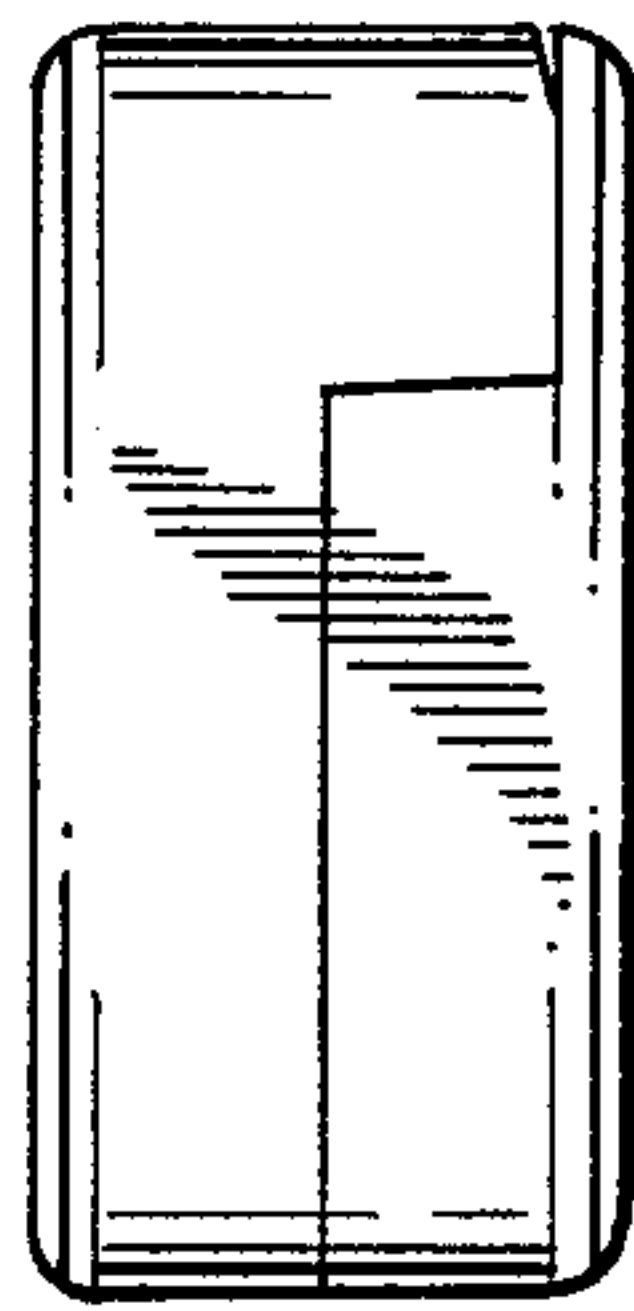

FIG. 4

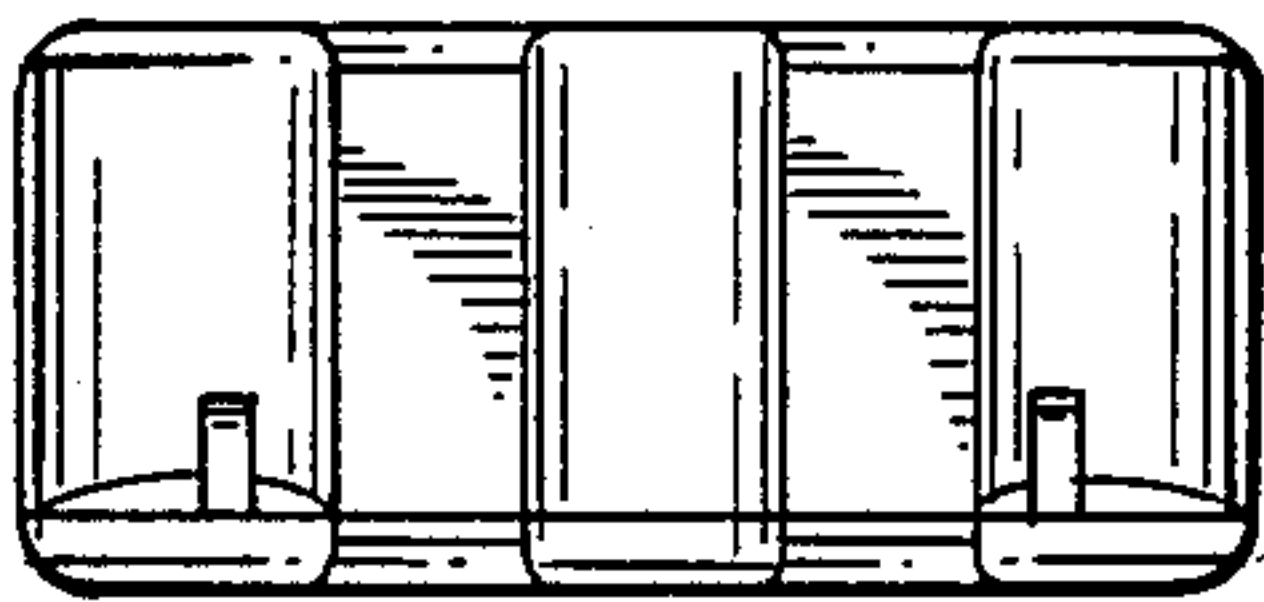

FIG. 5

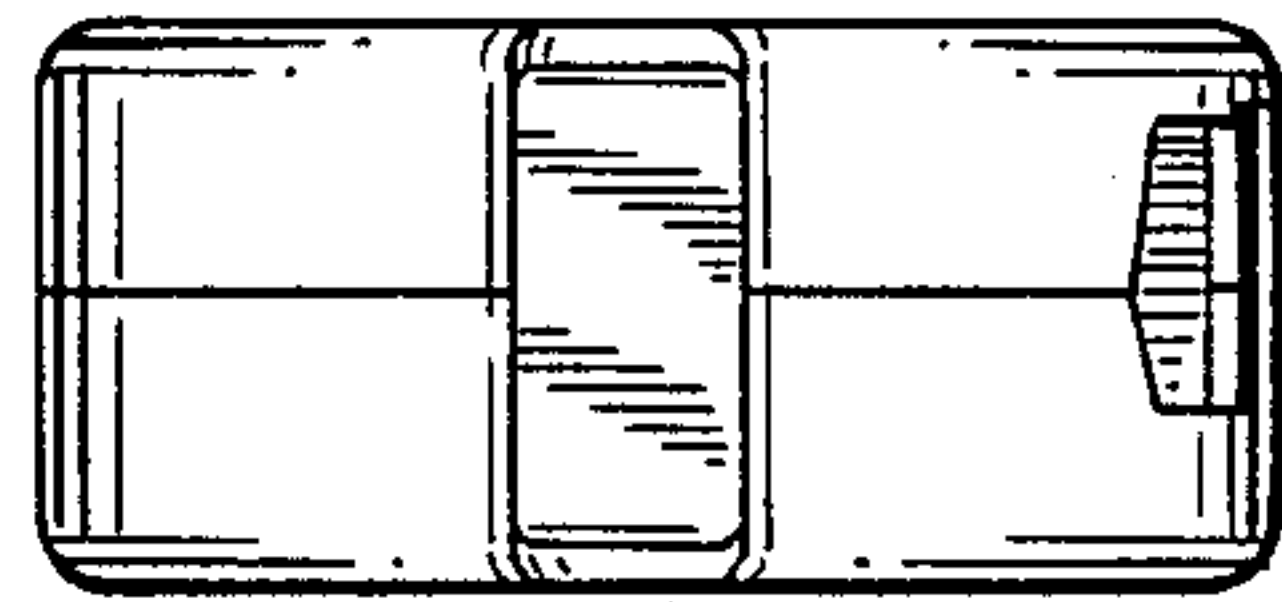

FIG. 6

