

[54] COMBINATION WIRELESS HANDSET TELEPHONE AND SPEAKER STAND THEREFOR

Primary Examiner—Horace B. Fay, Jr.
Attorney, Agent, or Firm—Fleit, Jacobson, Cohn, Price, Holman & Stern

[75] Inventors: Herbert Pfeifer, Campbell; Paul Montgomery, San Francisco, both of Calif.

[57] CLAIM

The ornamental design for a combination wireless handset telephone and speaker stand therefor, as shown and described.

[73] Assignee: Samsung Electronics Co., Ltd., Suwon, Rep. of Korea

DESCRIPTION

[**] Term: 14 Years

FIG. 1 is a front, left side and top of a combination wireless handset telephone and speaker stand therefor showing our new design in cradled relationship; FIG. 2 is a top plan view thereof; FIG. 3 is a right side elevational view thereof; FIGS. 4 and 5 are respectively front and rear elevational views thereof; FIG. 6 is a bottom plan view thereof; FIG. 7 is a left side elevational view thereof; FIG. 8 is a front, left side and top perspective view of the stand shown separately for clarity of representation; FIG. 9 is a bottom plan view of the stand alone; FIG. 10 is a right side elevational view of the stand alone; FIGS. 11 and 12 are respectively front and rear elevational views of the stand alone; FIG. 13 is a bottom plan view of the stand alone; FIG. 14 is a left side elevational view of the stand alone; FIG. 15 is a front, bottom and left side perspective view of the handset telephone alone; FIG. 16 is a bottom plan view of the handset telephone; FIG. 17 is a right side elevational view thereof; FIG. 18 is a bottom plan view of the handset telephone; FIGS. 19 and 20 are respectively front and rear elevational views of the handset telephone alone; and FIG. 21 is a left side elevational view of the handset telephone alone.

[21] Appl. No.: 232,880

[22] Filed: Aug. 16, 1988

[30] Foreign Application Priority Data

Apr. 19, 1988 [KR] Rep. of Korea 1988-5292

[52] U.S. Cl. D14/142; D14/151; D14/147; D14/148; D14/138

[58] Field of Search D14/138, 140, 142, 151, D14/141, 147, 148, 248; 379/440, 419, 420, 428, 432, 434, 436, 58, 59, 60, 61, 62

[56] References Cited

U.S. PATENT DOCUMENTS

- D. 210,776 4/1968 Dreyfuss et al. D14/149
- D. 243,536 3/1977 van de Poel D14/159
- D. 284,760 7/1986 Keating D14/138
- D. 285,557 9/1986 Bocko D14/151
- D. 286,531 11/1986 Lee D14/151
- D. 292,580 11/1987 Wang D14/151
- D. 292,919 11/1987 Layenbielke et al. D14/151
- D. 293,572 1/1988 Büchin D14/149
- D. 296,692 7/1988 Besford et al. D14/138
- D. 298,620 11/1988 Ohta et al. D14/149
- D. 299,026 12/1988 Iino D14/150

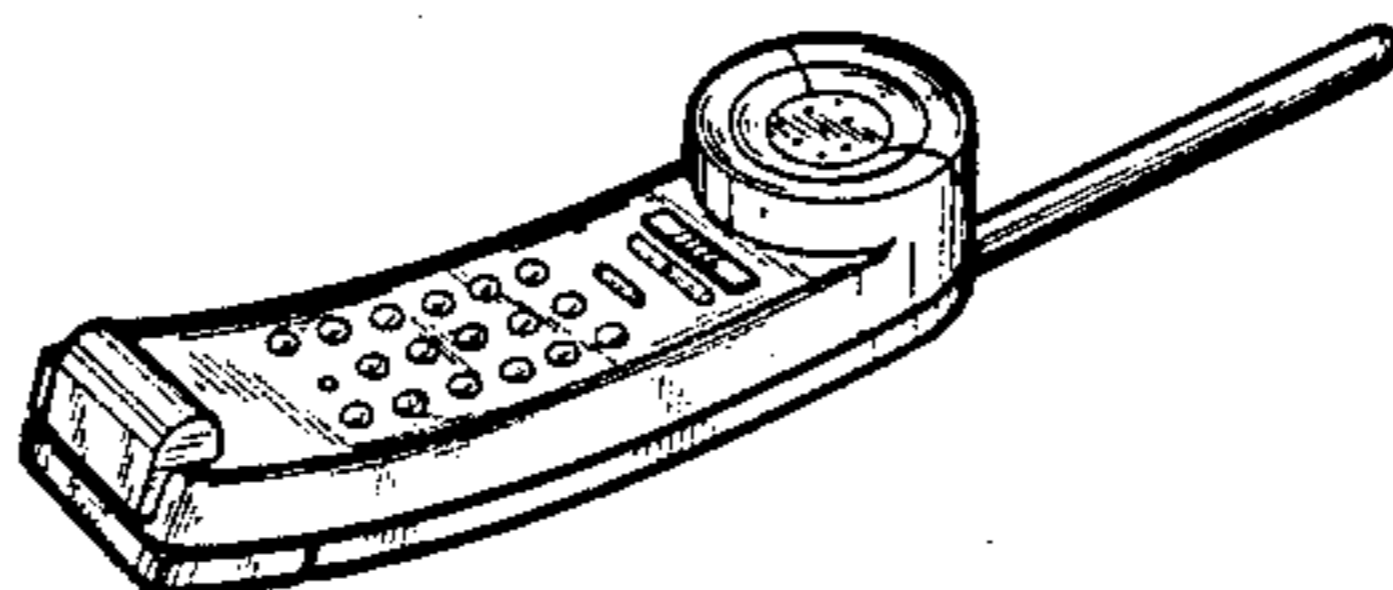
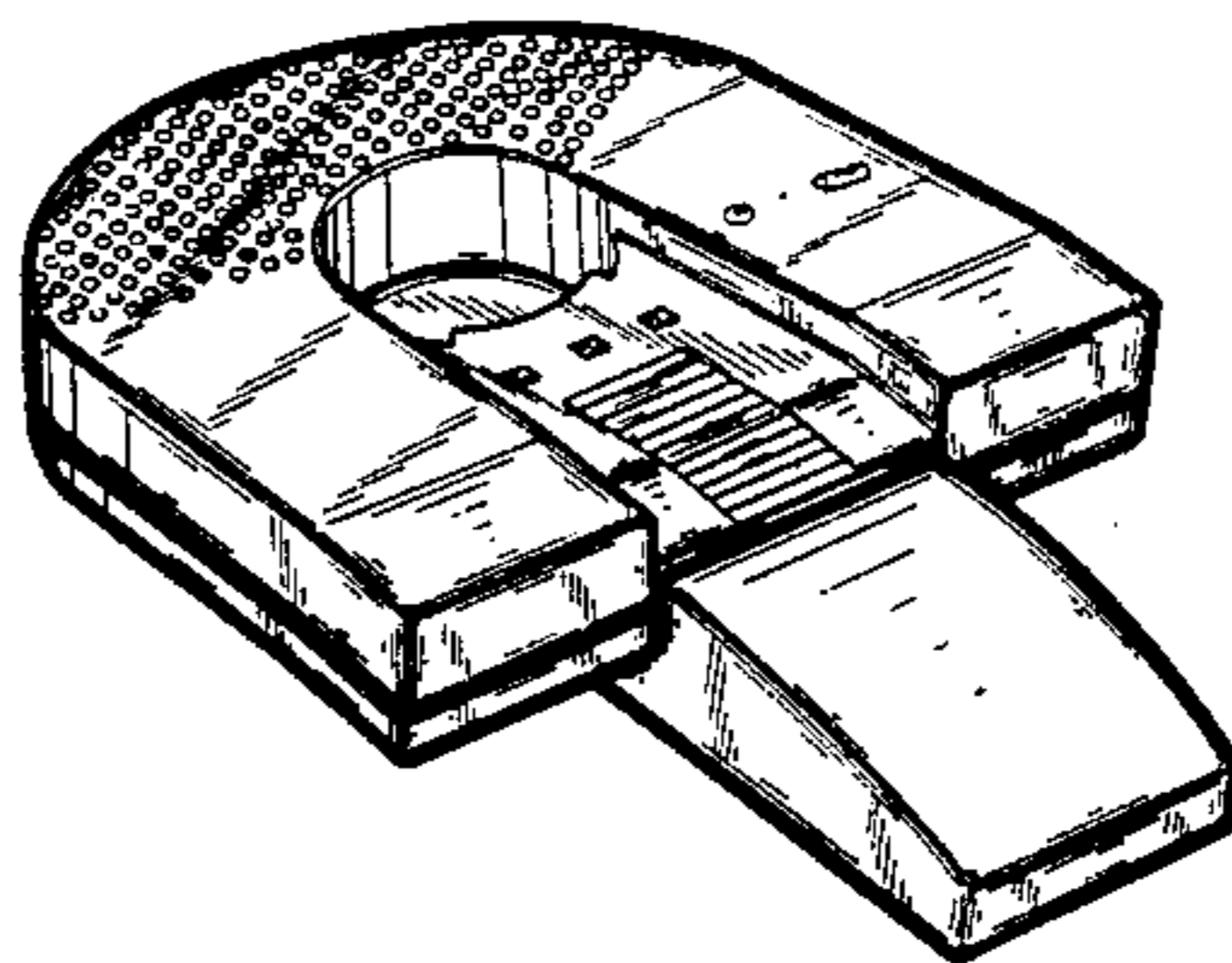

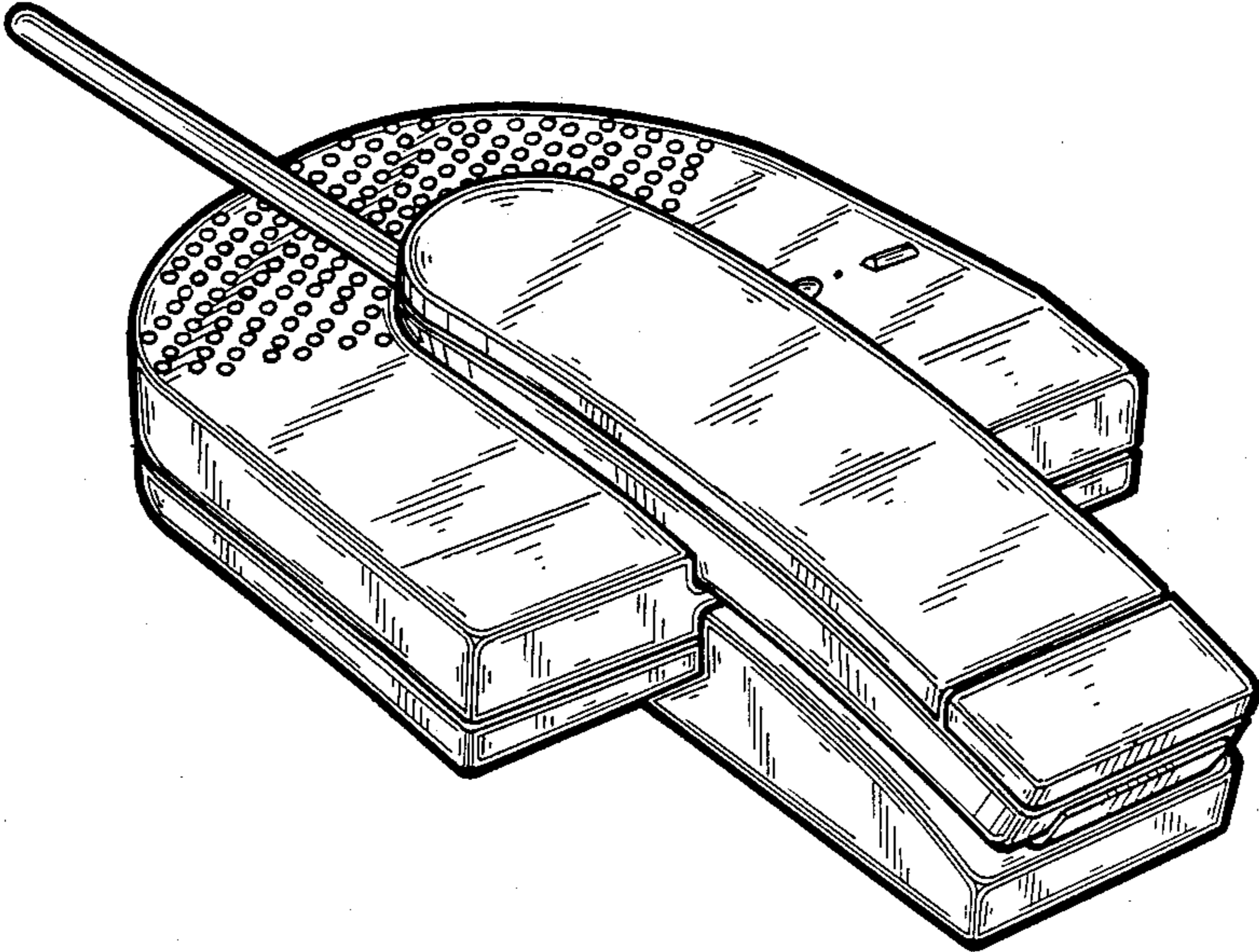

FIG. 1

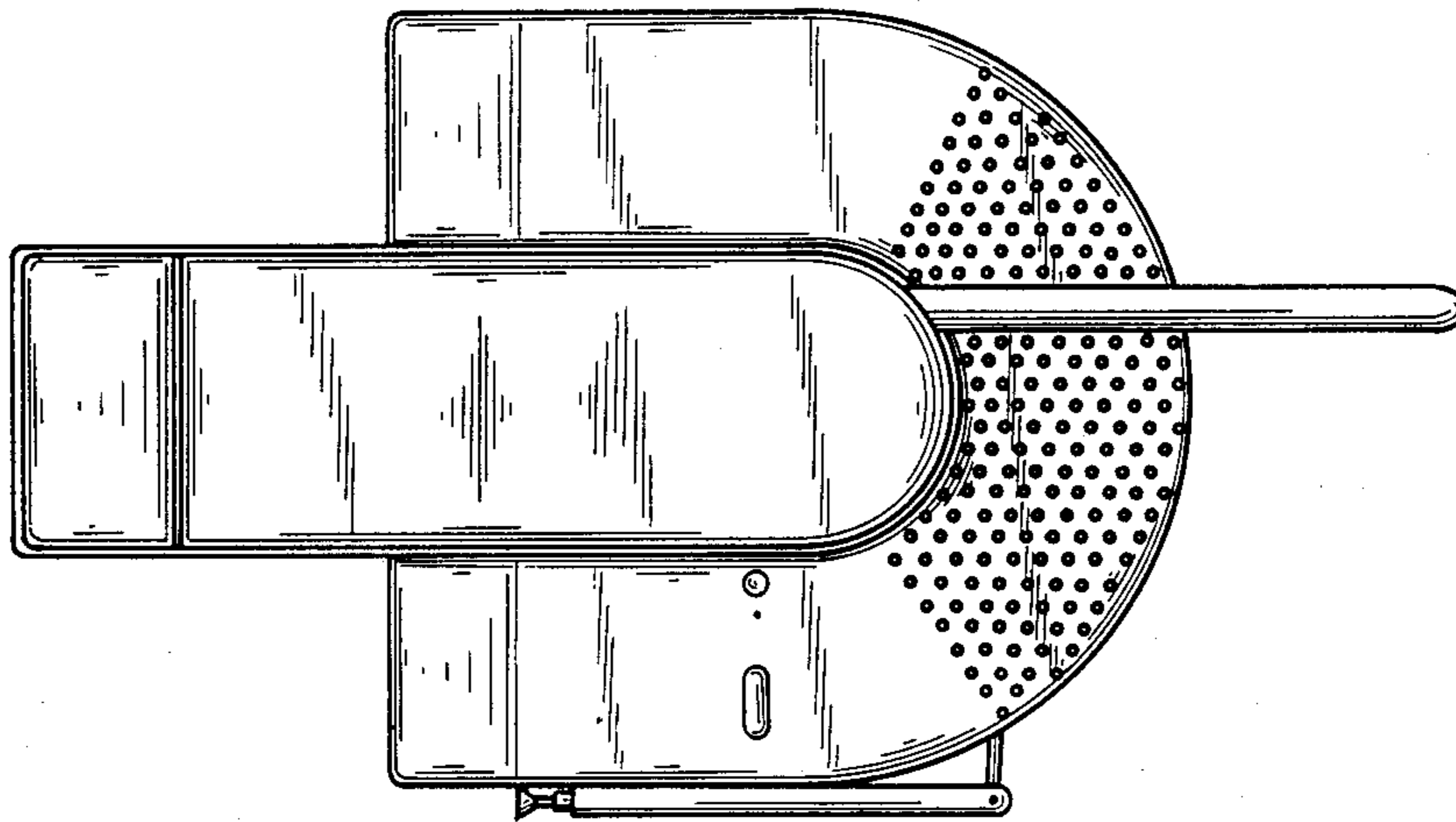

FIG. 2

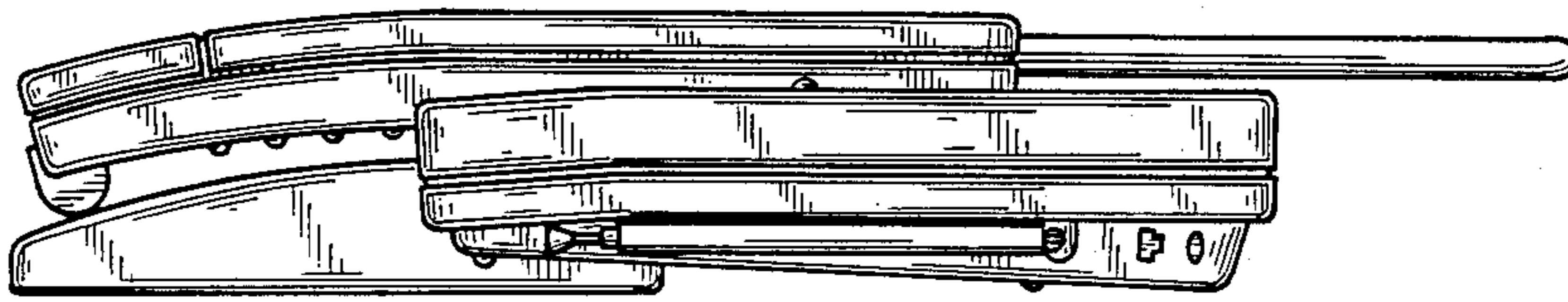

FIG. 3

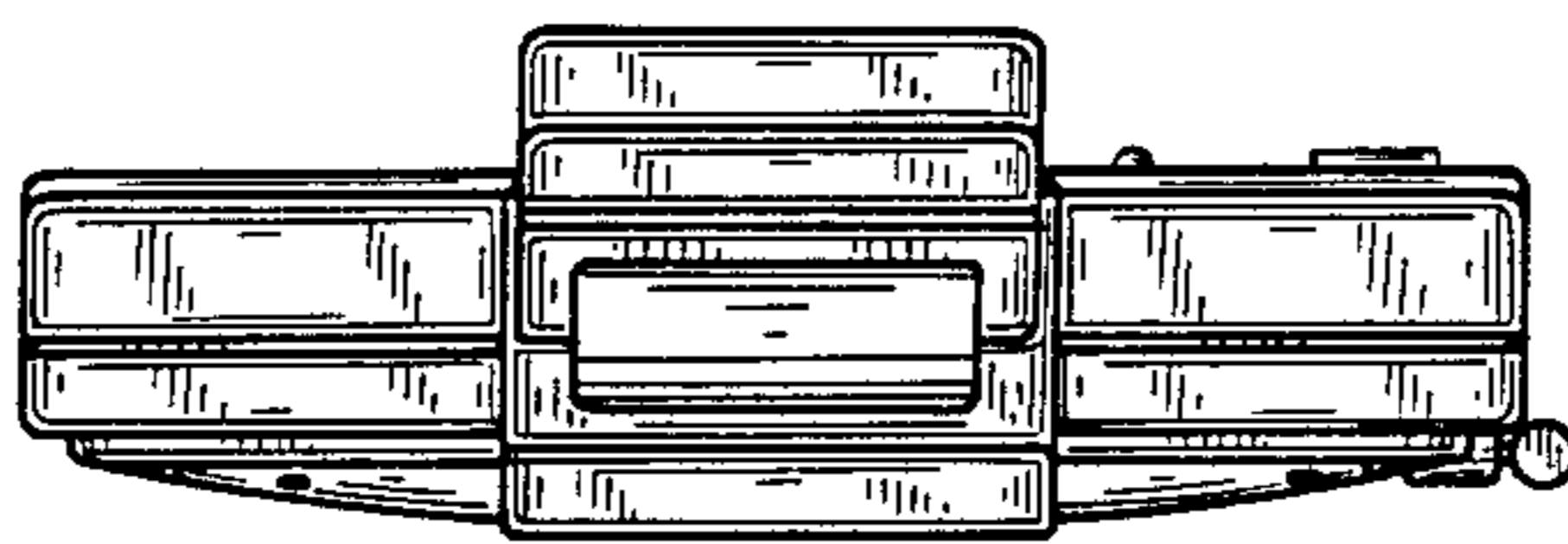

FIG. 4

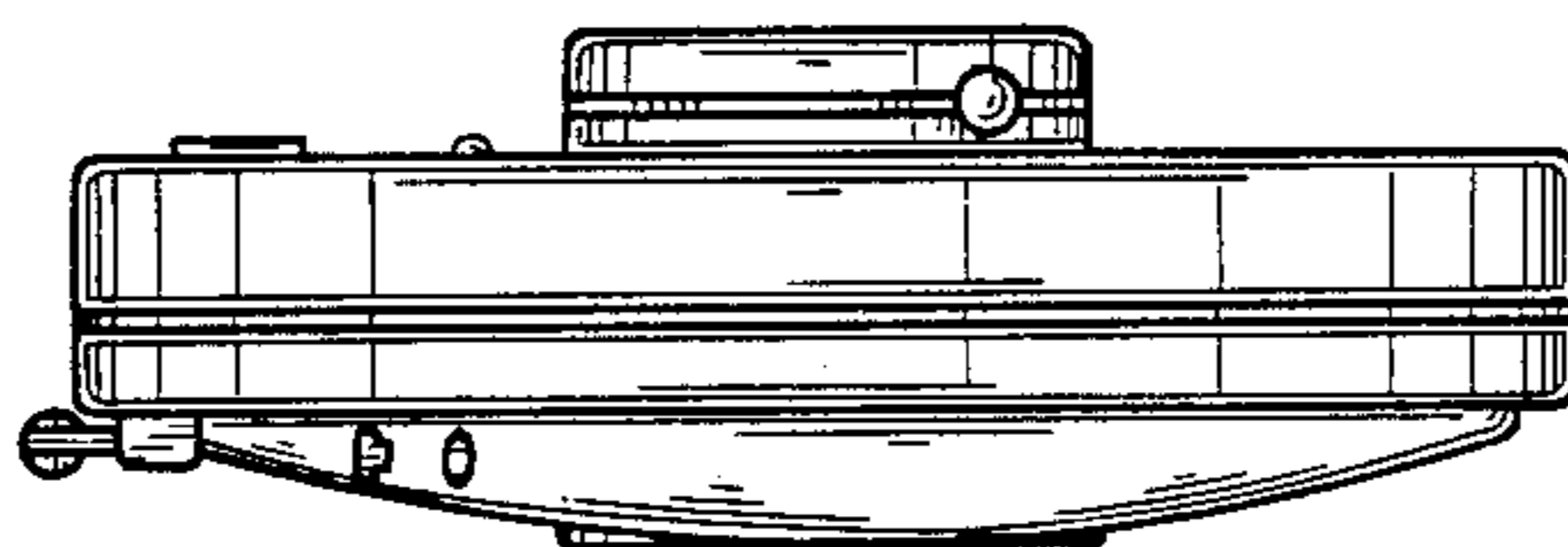

FIG. 5

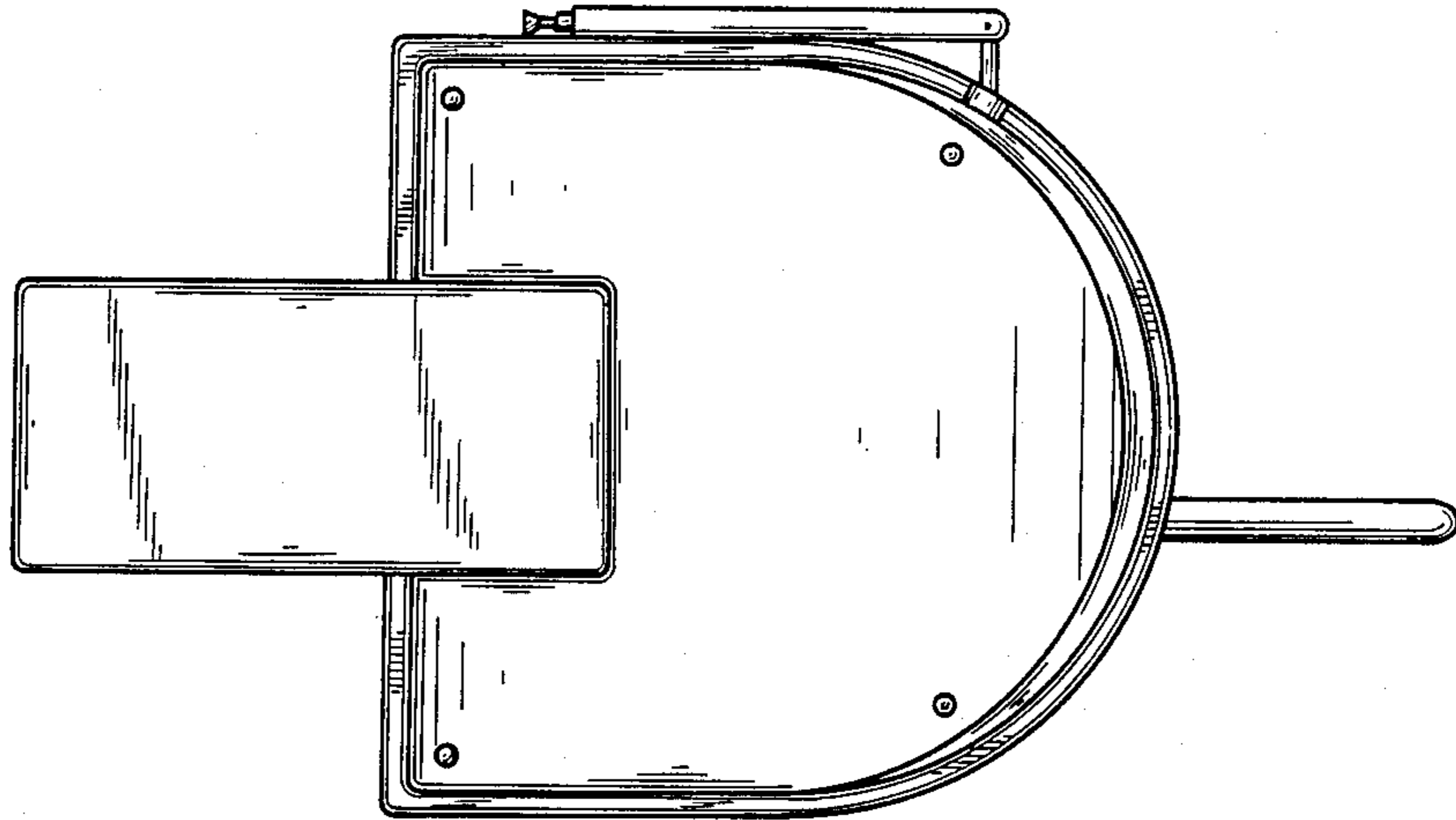

FIG. 6

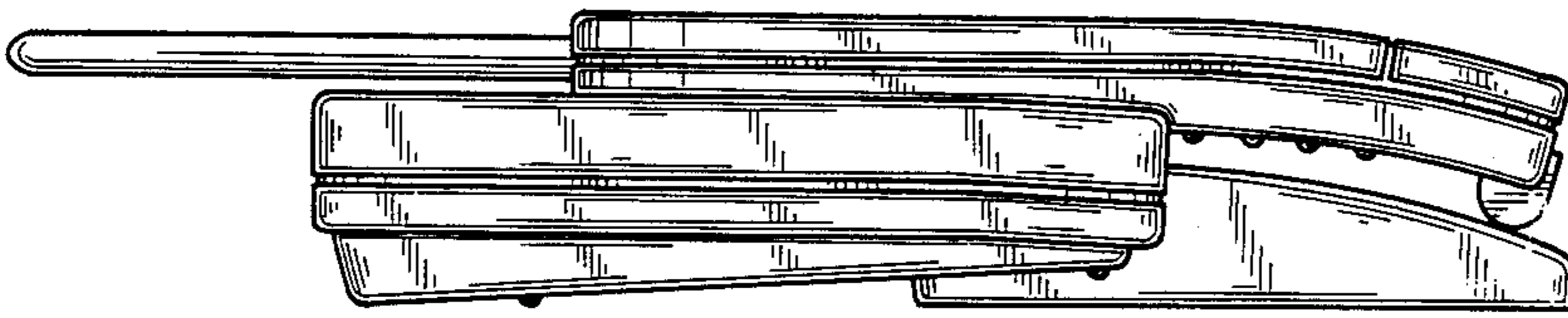

FIG. 7

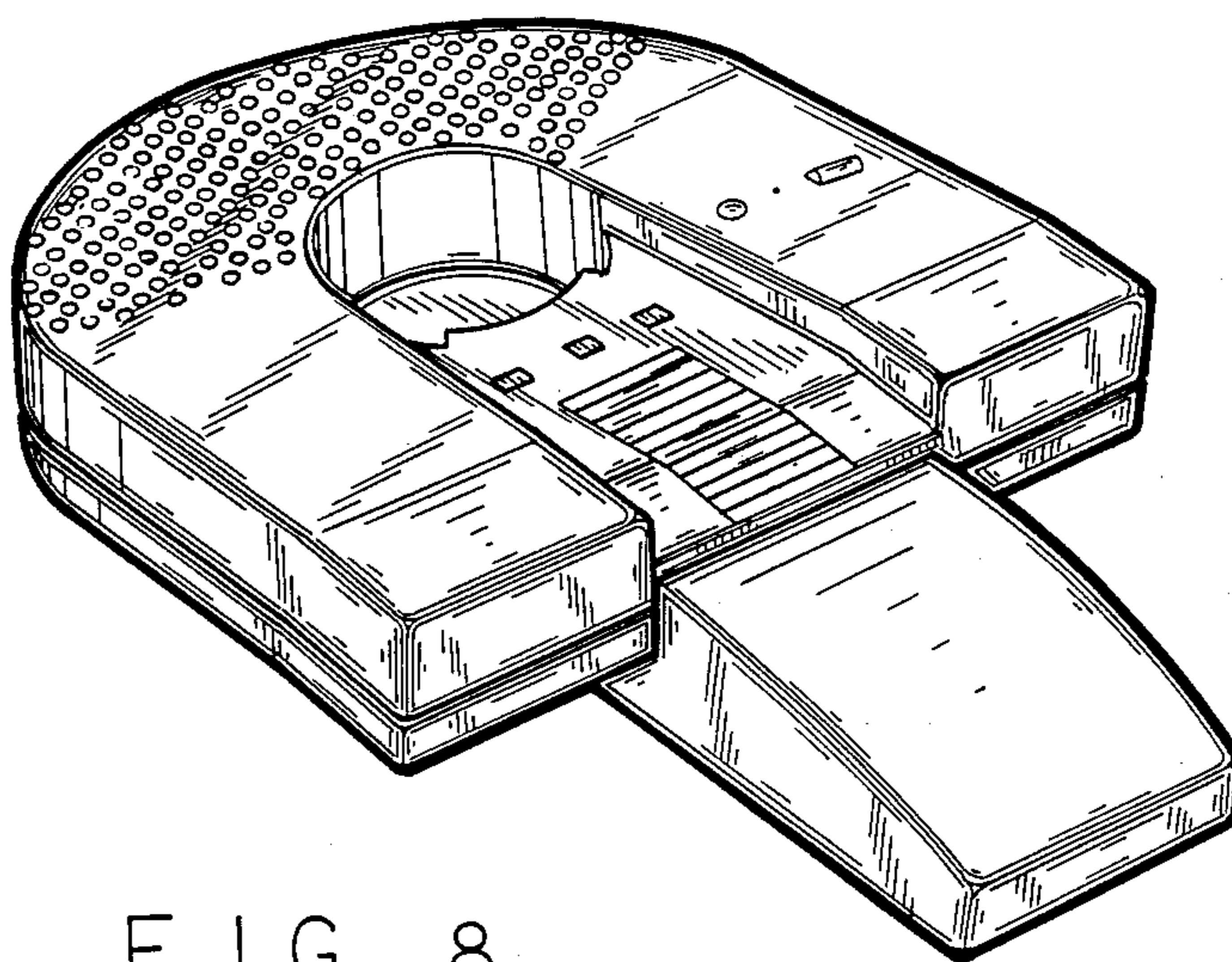

FIG. 8

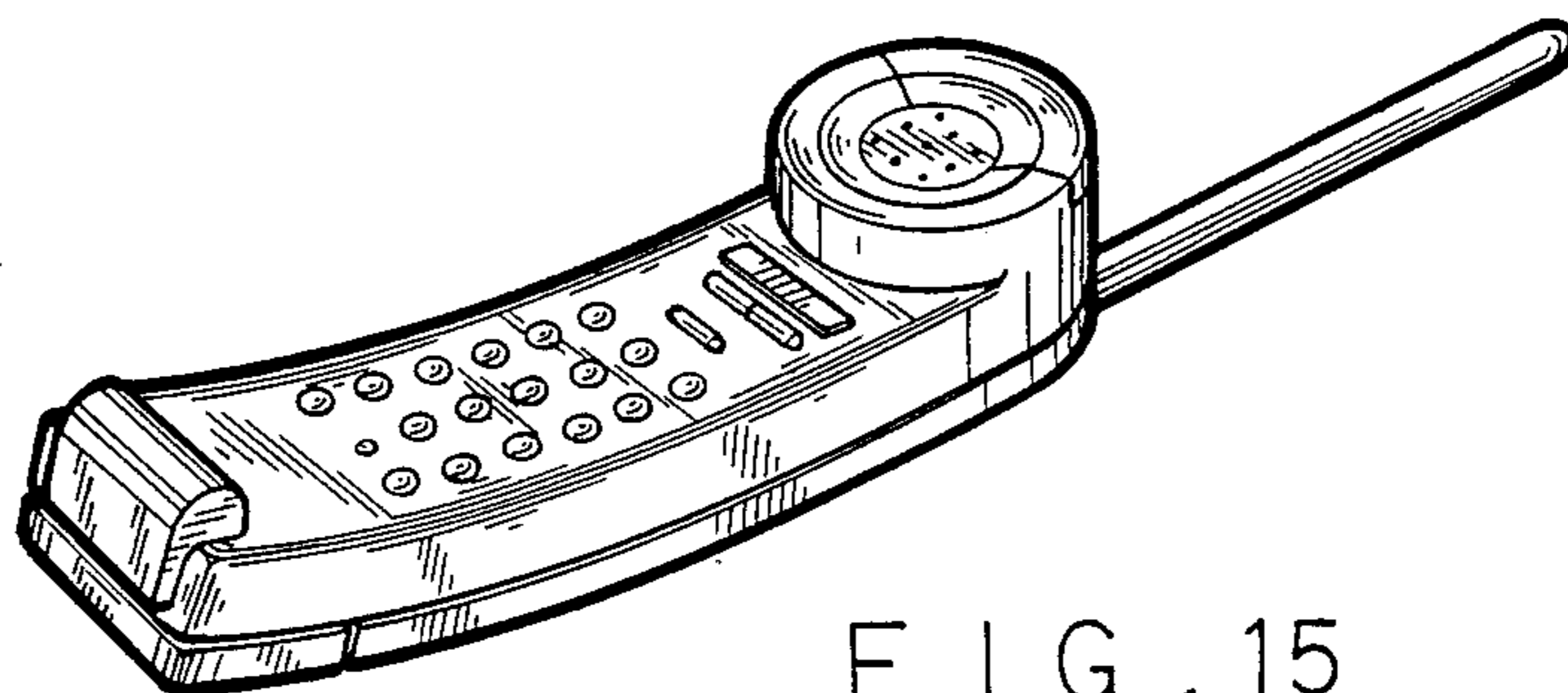

FIG. 15

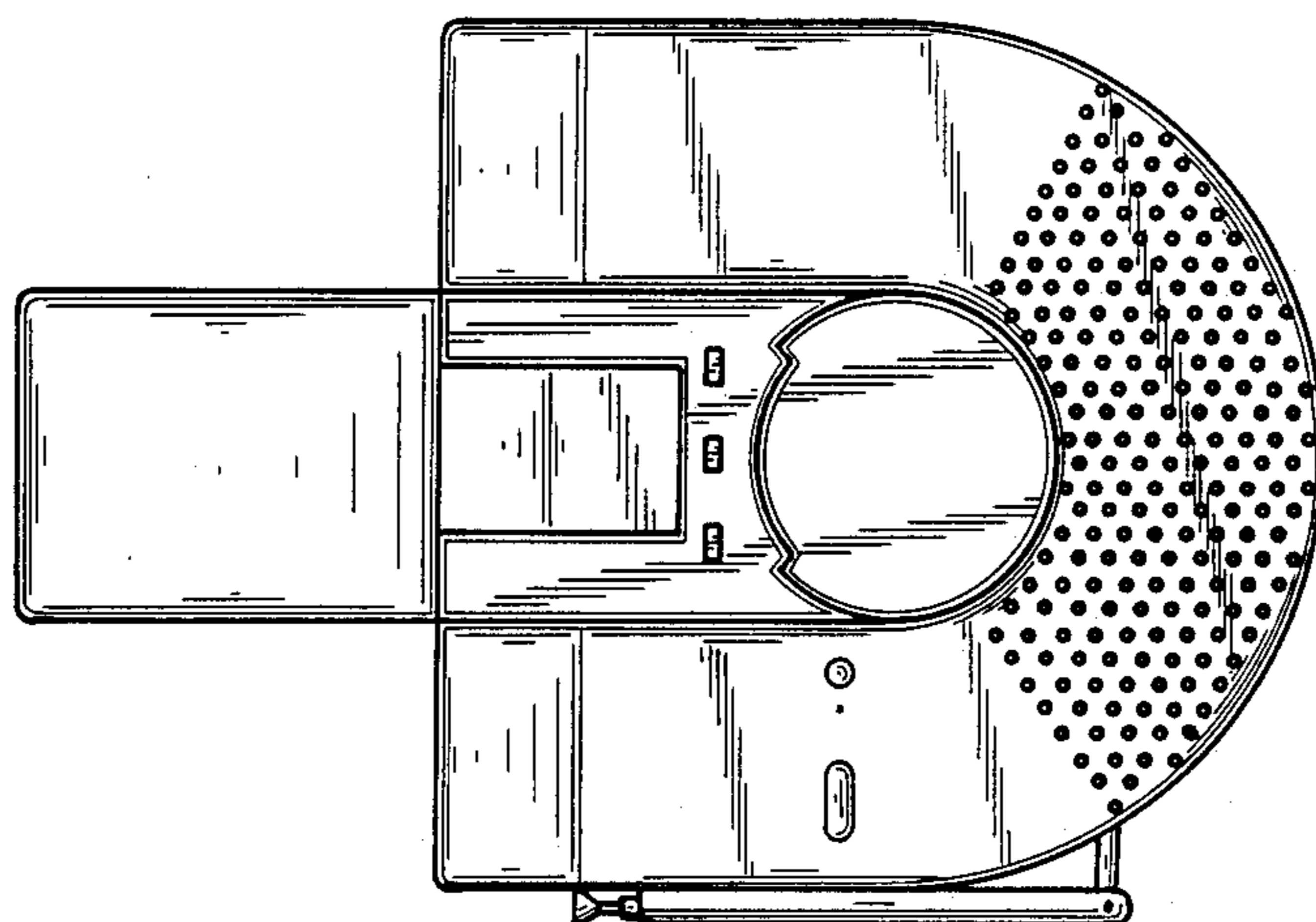

FIG. 9

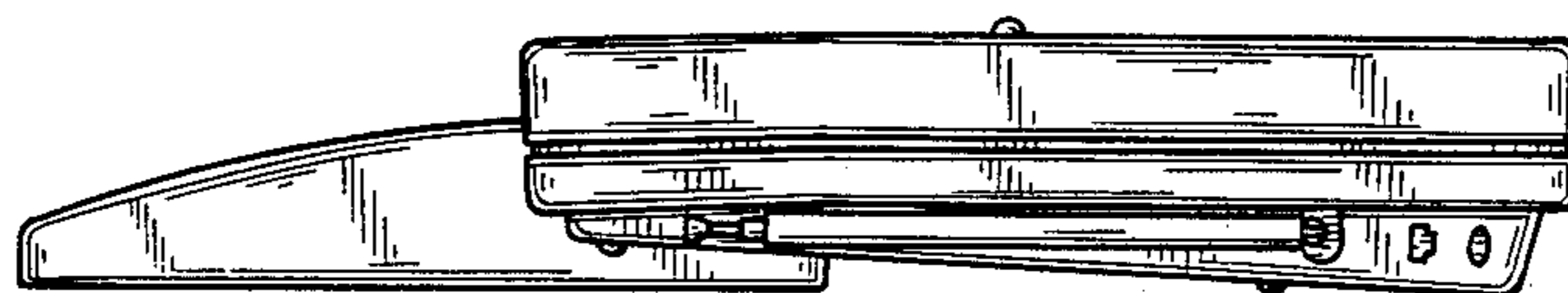

FIG. 10

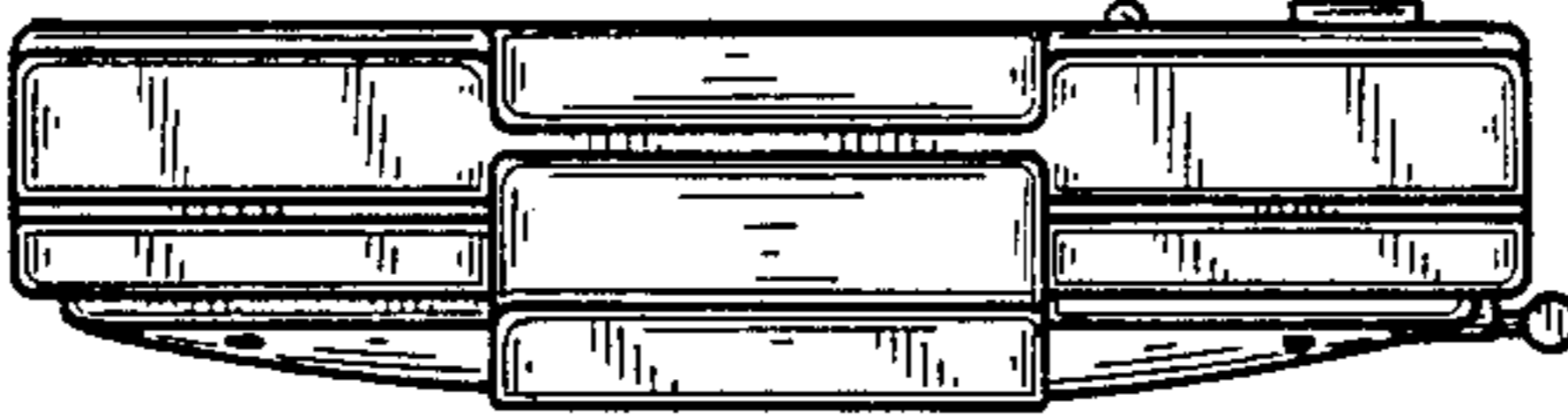

FIG. 11

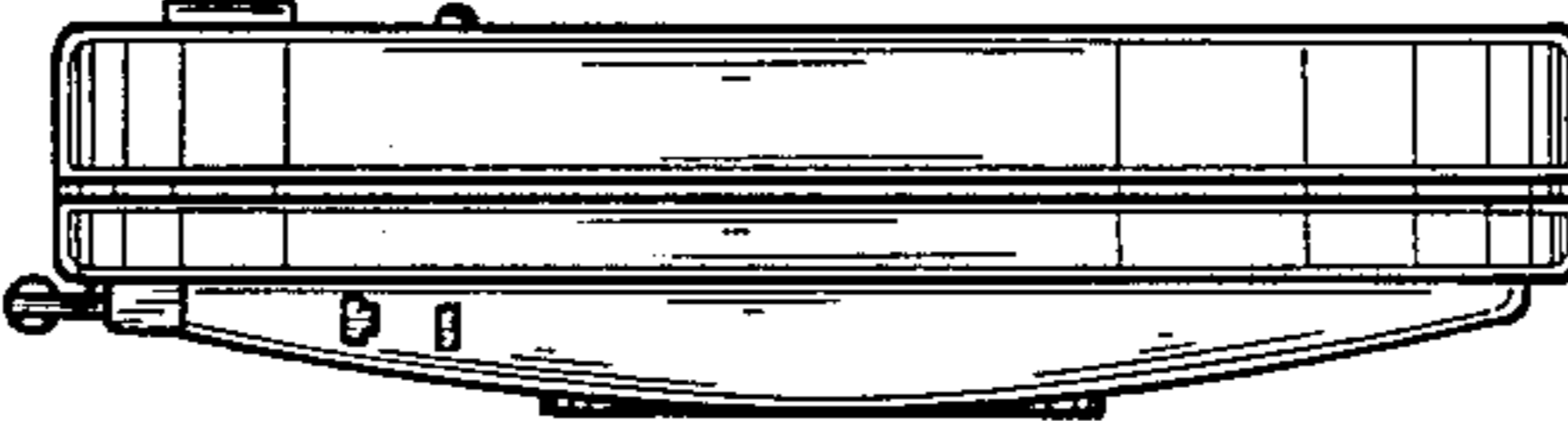

FIG. 12

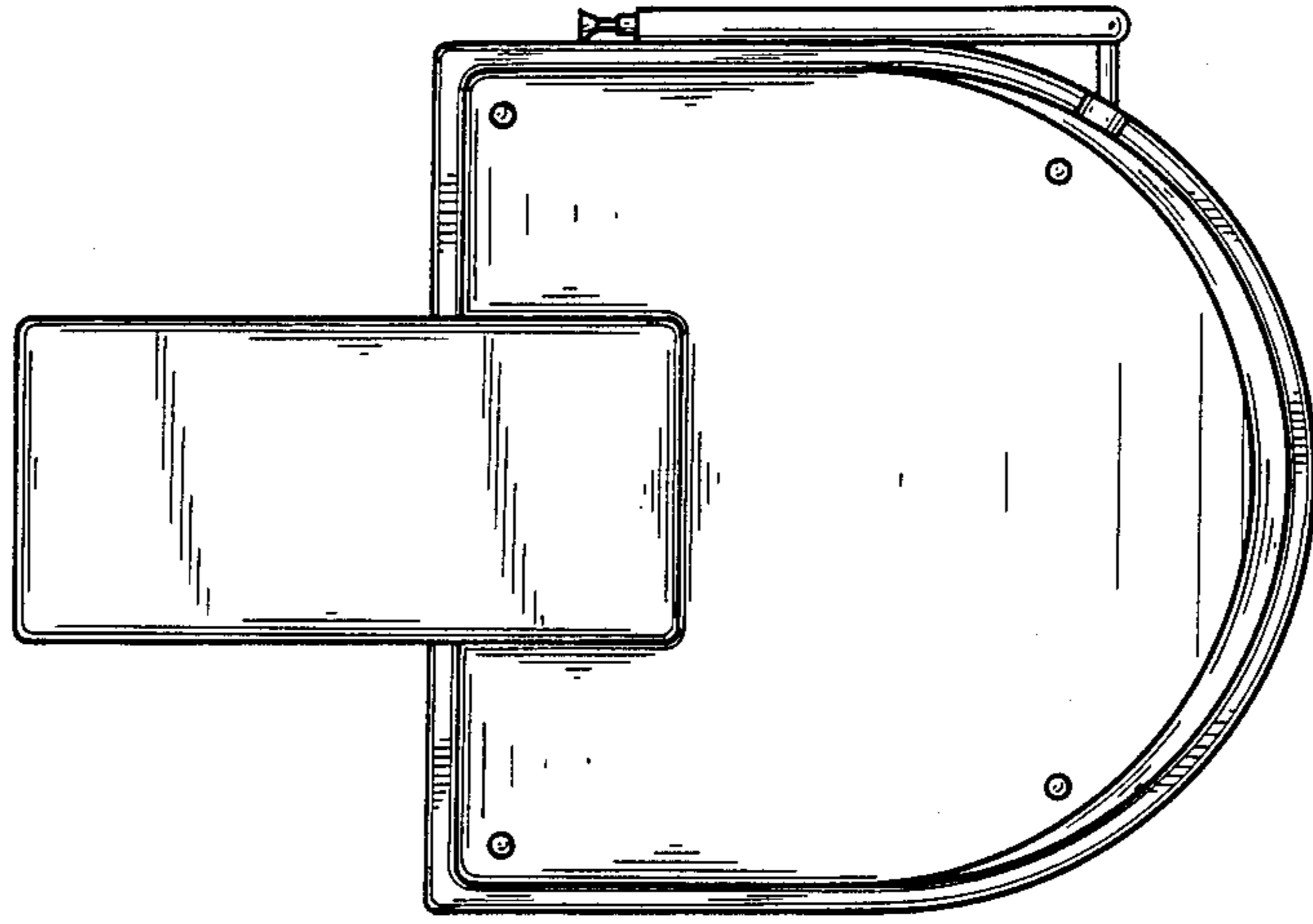

FIG. 13

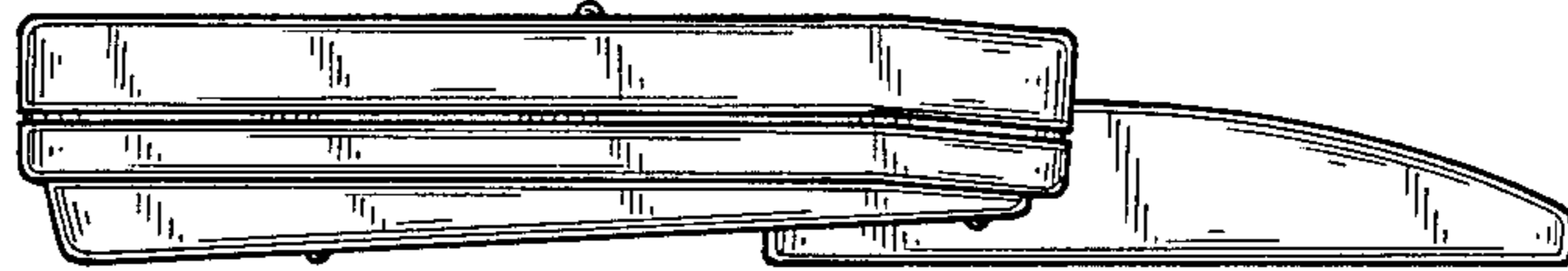

FIG. 14

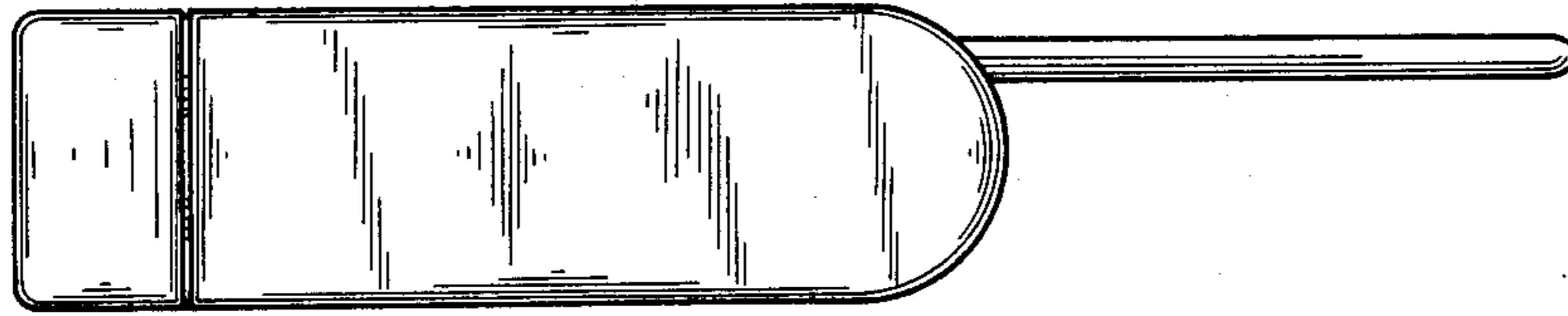

FIG. 16

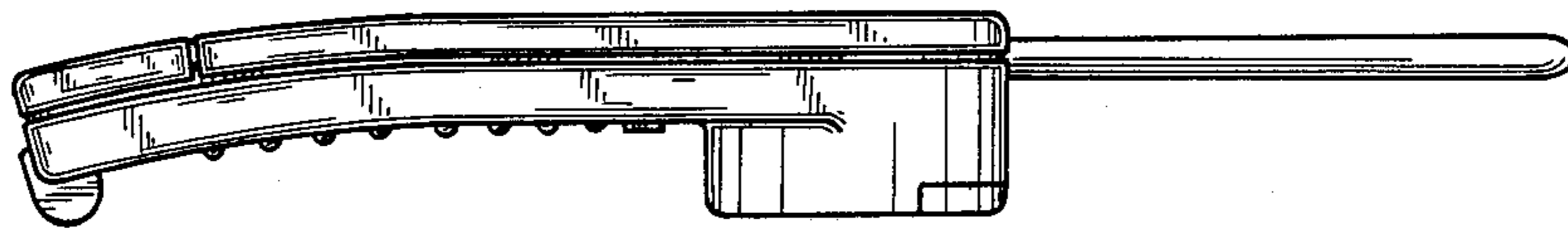

FIG. 17

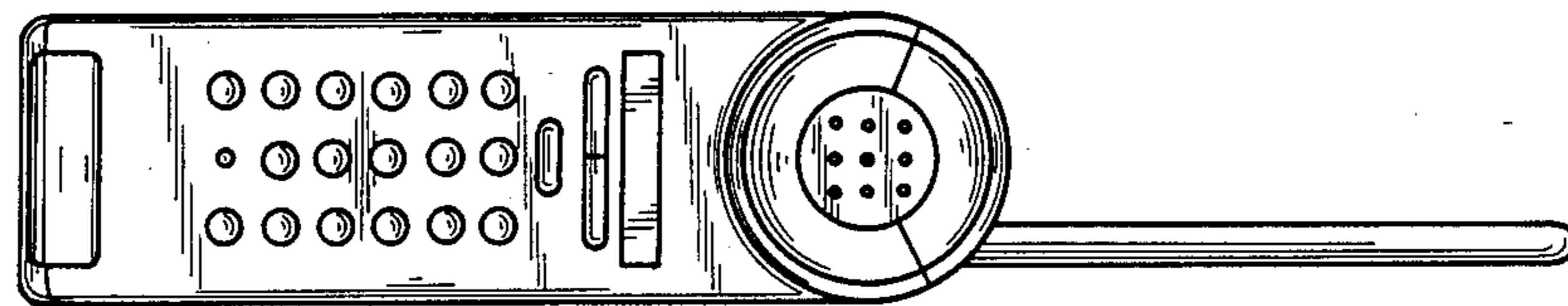

FIG. 18



FIG. 19

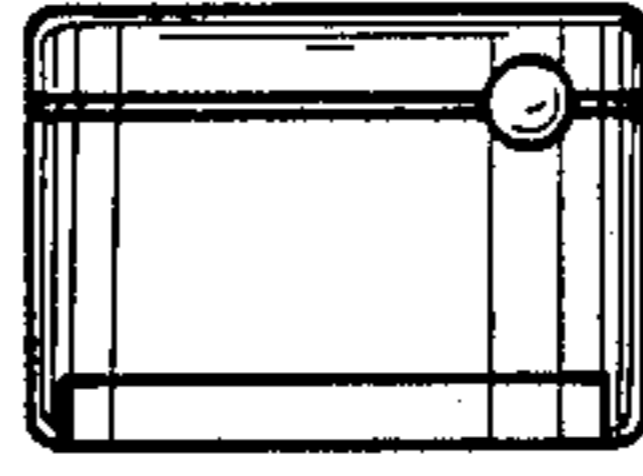

FIG. 20

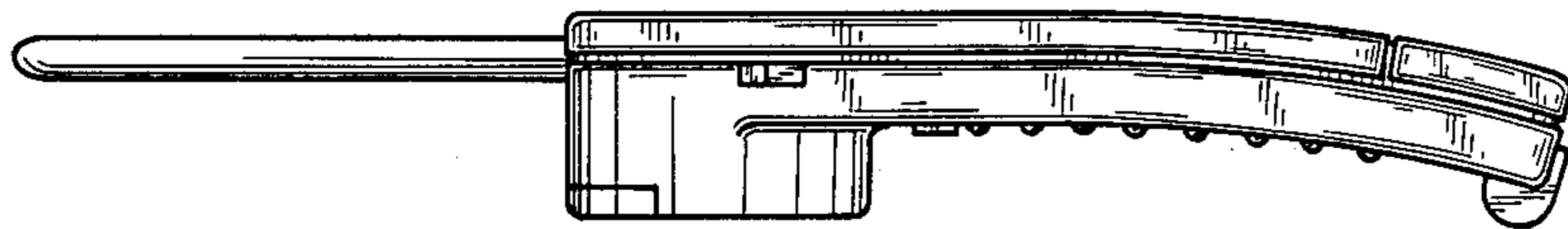

FIG. 21