

[54] DOOR LIGHT FRAME

[75] Inventors: David A. De Block; Kert E. Artwick, both of Holland, Mich.

[73] Assignee: ODL, Incorporated, Zeeland, Mich.

[**] Term: 14 Years

[21] Appl. No.: 851,381

[22] Filed: Apr. 10, 1986

[52] U.S. Cl. D25/60; D25/48; D25/52; D25/119

[58] Field of Search 52/400, 204, 404; 49/463, DIG. 2, 261, 656; D25/48, 52, 119, 123, 60

[56] References Cited

U.S. PATENT DOCUMENTS

| | | | |
|------------|---------|------------------------|-----------|
| D. 204,664 | 5/1966 | Halko, Jr. et al. | D25/52 X |
| 2,101,349 | 12/1937 | Sharp | D25/119 X |
| 2,304,598 | 12/1942 | Plym | D25/52 X |
| 2,705,415 | 4/1955 | Livesay . | |
| 2,775,798 | 1/1957 | Bent | D25/52 X |
| 2,878,667 | 3/1959 | Jones . | |
| 2,996,767 | 8/1961 | Kobil et al. . | |
| 3,184,801 | 5/1965 | Fletcher . | |
| 3,349,536 | 10/1967 | Halko, Jr. et al. . | |
| 3,352,060 | 11/1967 | Thams . | |
| 3,576,092 | 4/1971 | Halpern | D25/48 X |
| 3,750,358 | 8/1973 | Lewkowitz . | |
| 3,769,769 | 11/1973 | Kohl . | |
| 4,010,585 | 3/1977 | Bliven . | |
| 4,433,517 | 2/1984 | Moore, Jr. . | |

OTHER PUBLICATIONS

Promotional Flyer entitled, "ODL's New Uni-Guard Ventilating Door Light", published by ODL Incorporated (Copyright 1984).

Primary Examiner—A Hugo Word
Attorney, Agent, or Firm—Warner, Norcross & Judd

[57] CLAIM

The ornamental design for a door light frame, as shown and described.

DESCRIPTION

FIG. 1 is a front elevational view of a door light frame embodying our new design;
 FIG. 2 is a rear elevational view thereof;
 FIG. 3 is a fragmentary perspective view of the upper left-hand corner of the frame shown in FIG. 1;
 FIG. 4 is a fragmentary elevational view of the upper left-hand corner of the frame shown in FIG. 1;
 FIG. 5 is a fragmentary top plan view of the front frame portion shown in FIG. 1;
 FIG. 6 is a fragmentary perspective view of the upper left-hand corner of the rear frame portion shown in FIG. 2;
 FIG. 7 is a fragmentary elevational view of the upper left-hand corner of the rear frame portion shown in FIG. 2;
 FIG. 8 is a fragmentary perspective view of the left center cross member shown in FIG. 2; and
 FIG. 9 is a fragmentary elevational view of the left center cross member shown in FIG. 2.

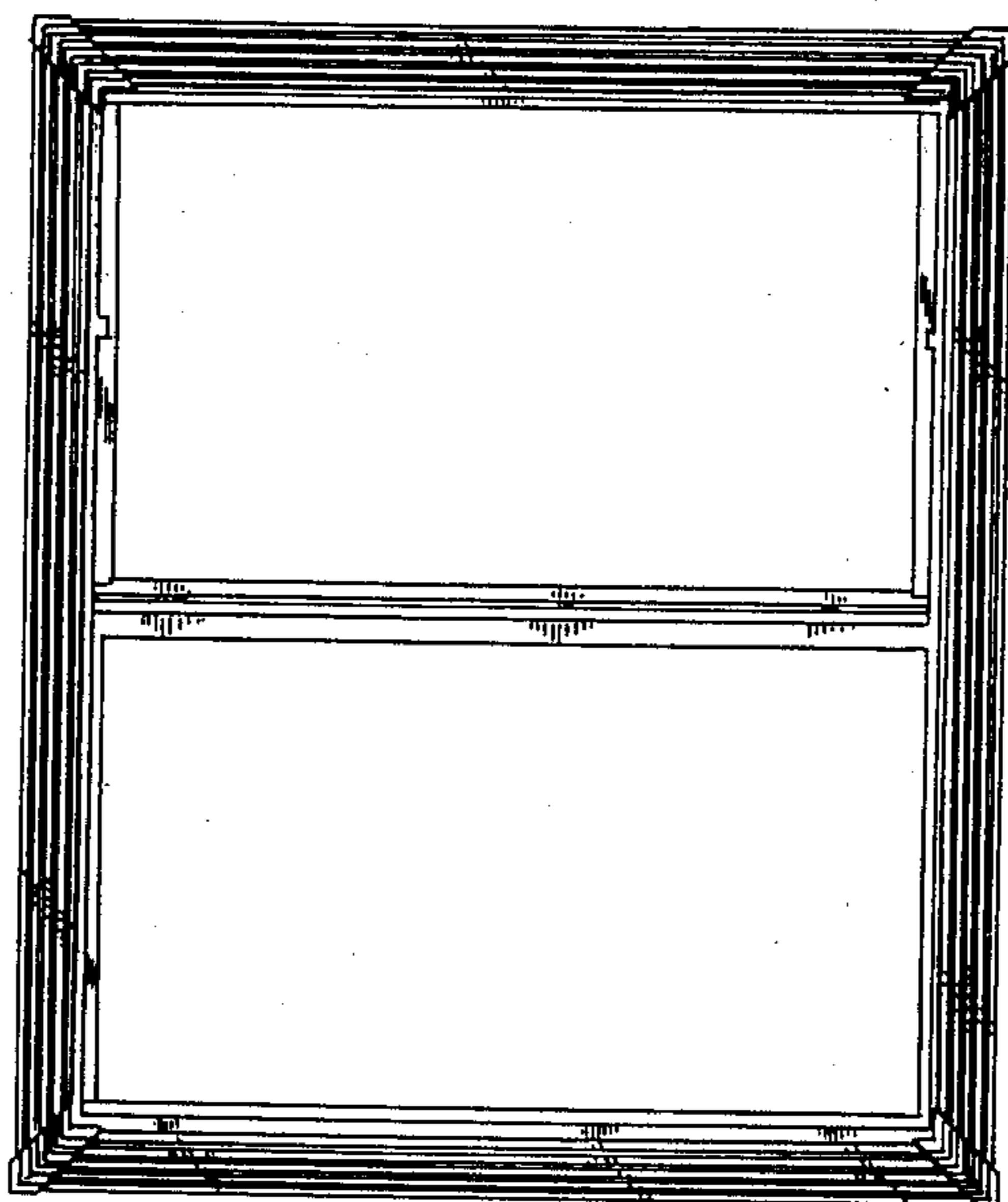

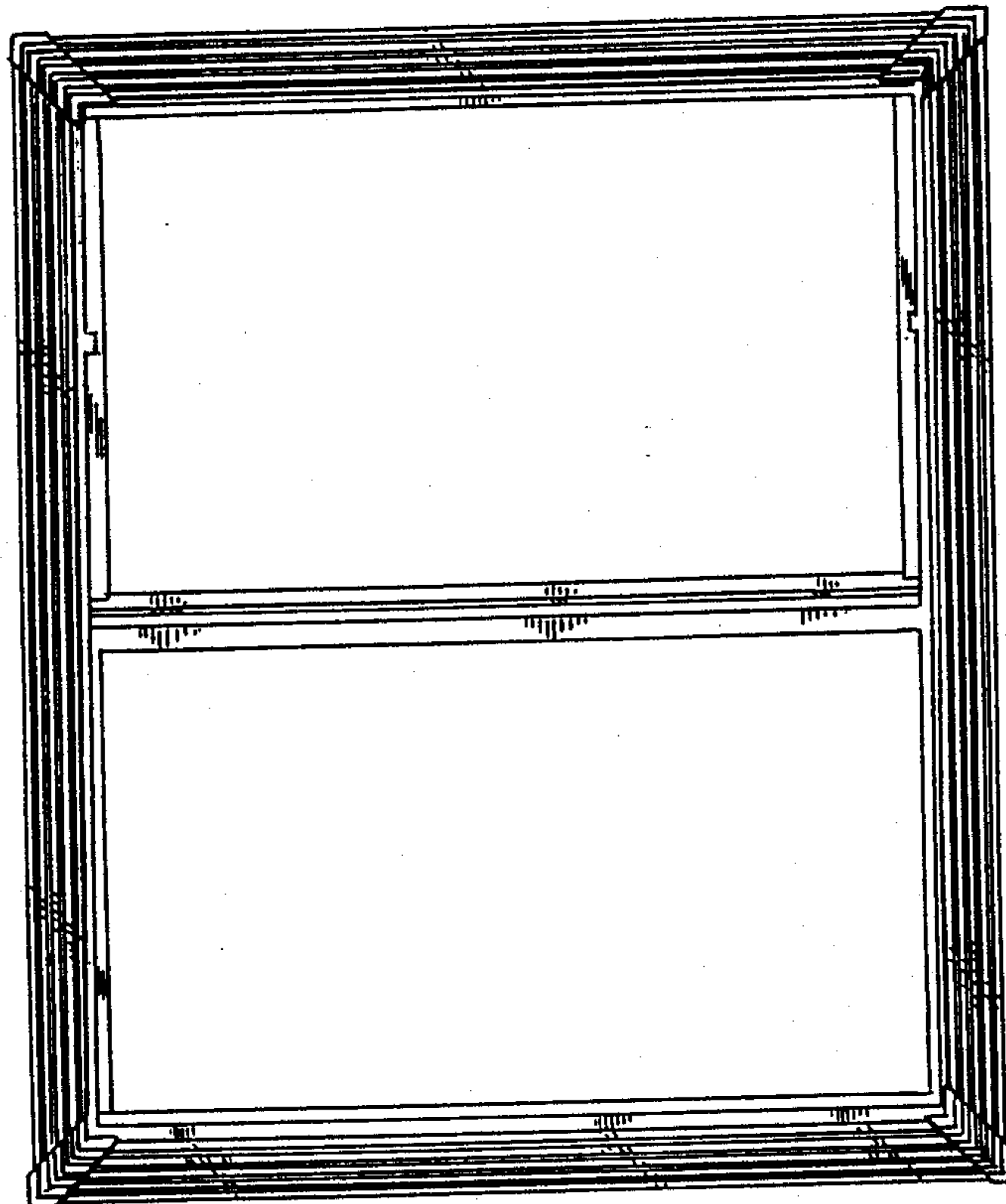

FIG. 1

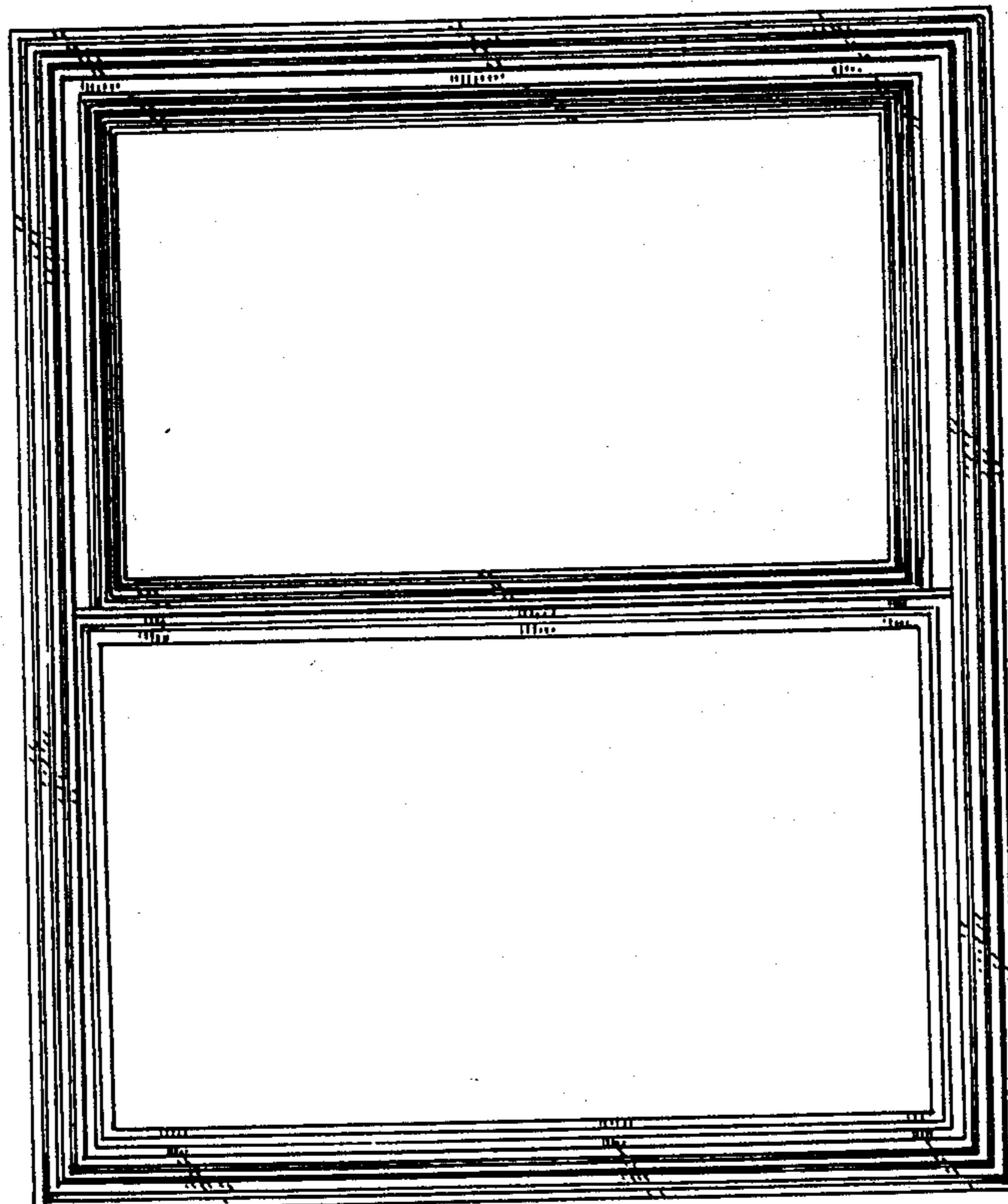

FIG. 2

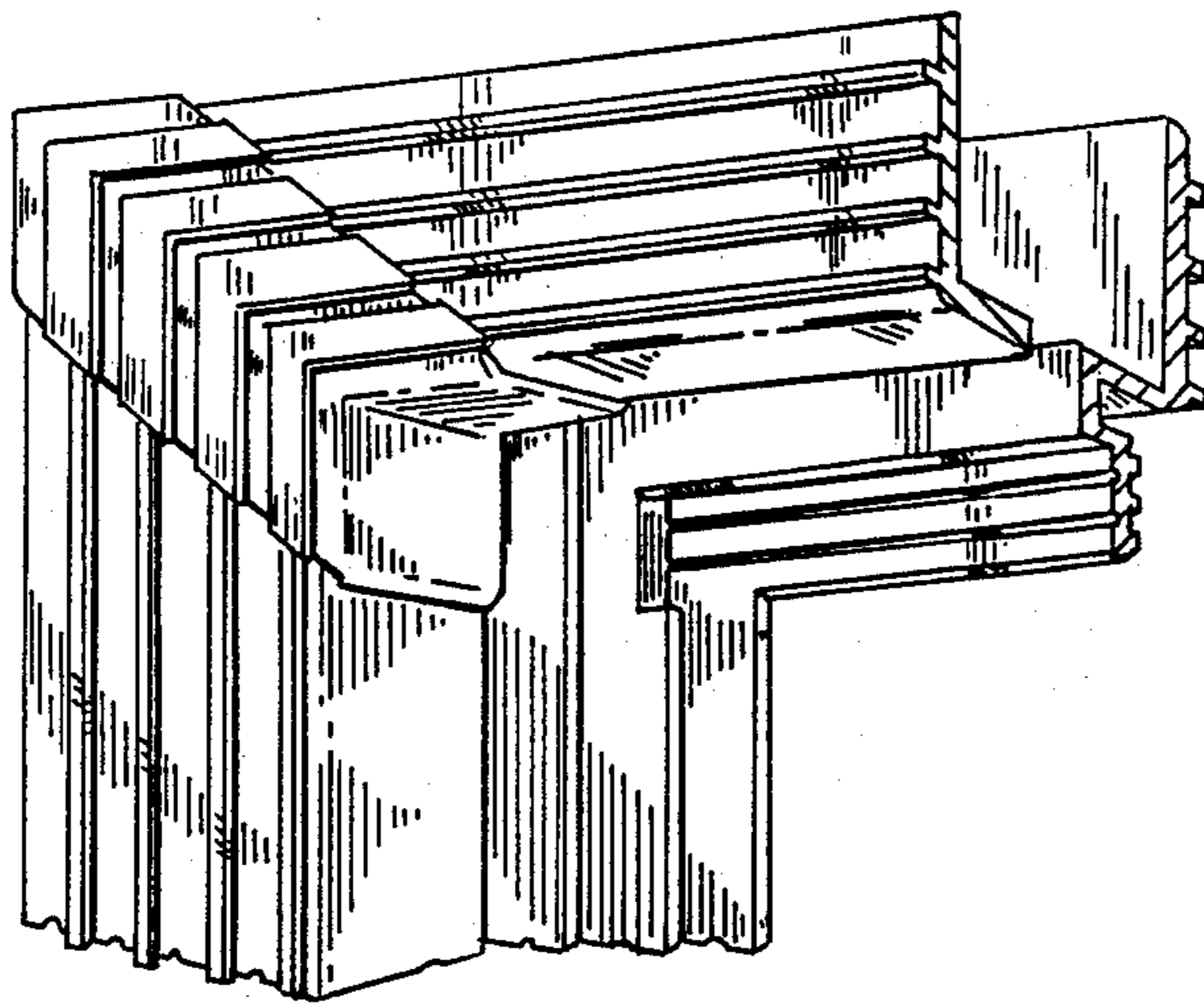

FIG. 3



FIG. 5

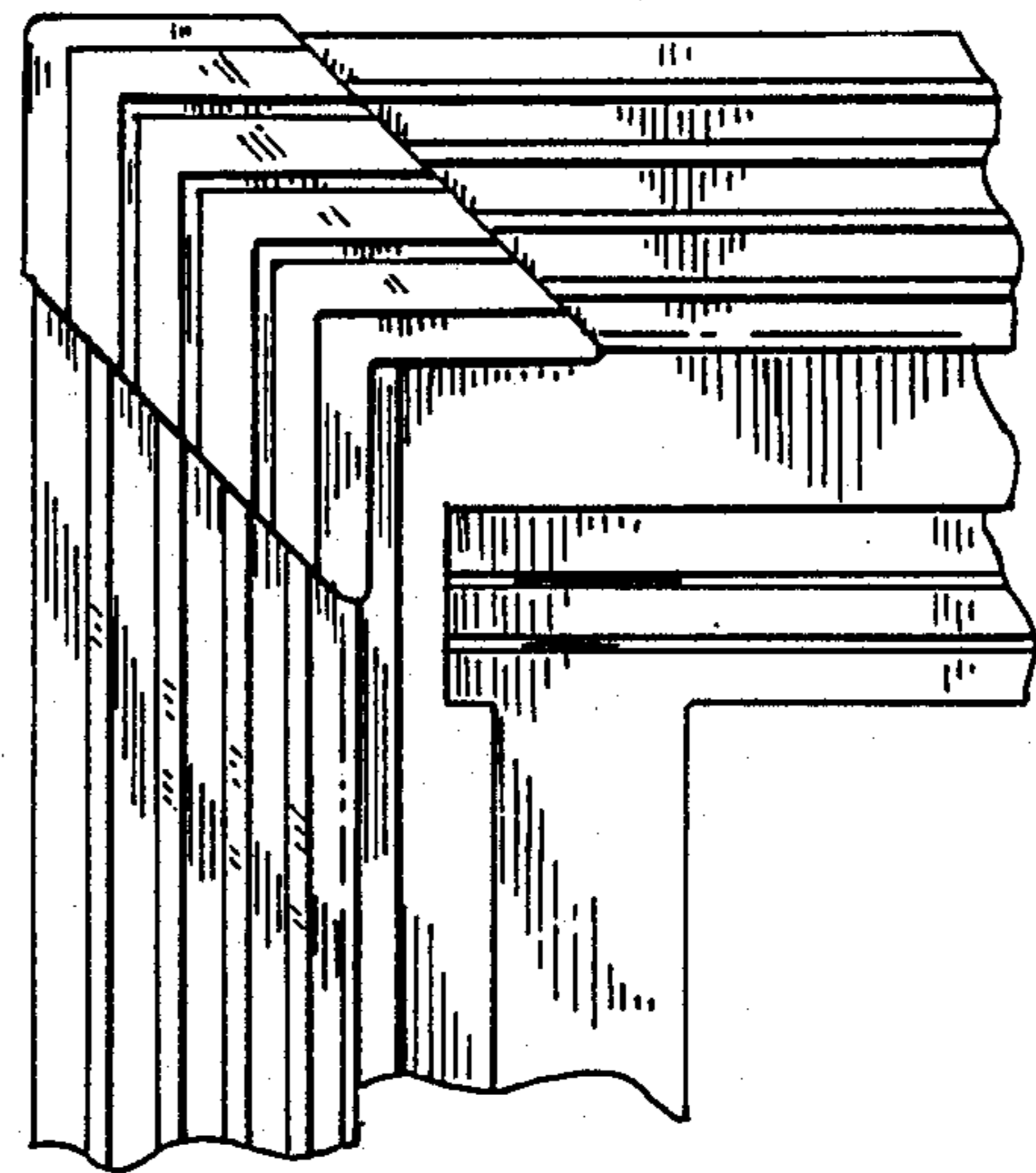

FIG. 4

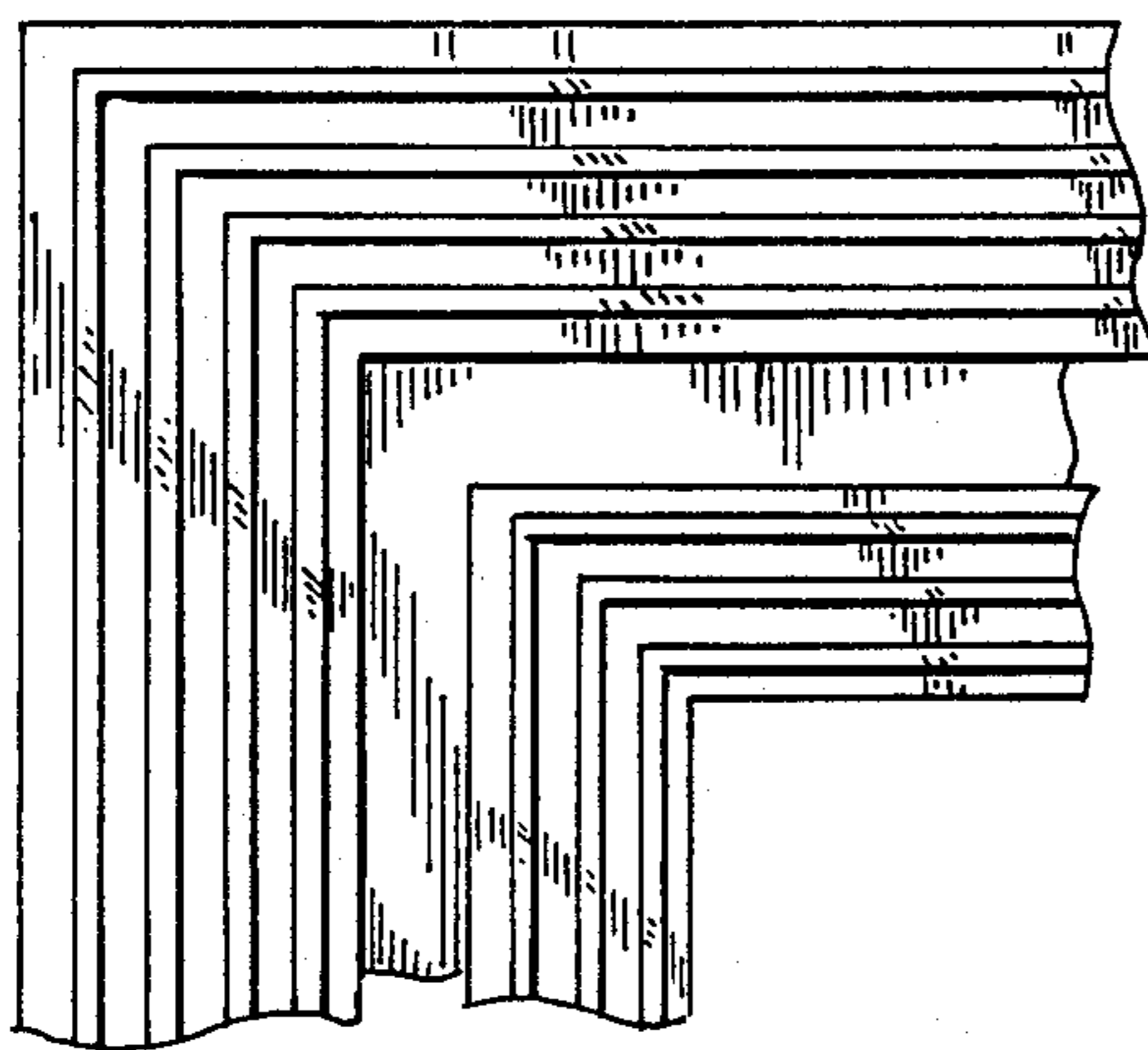

FIG. 7

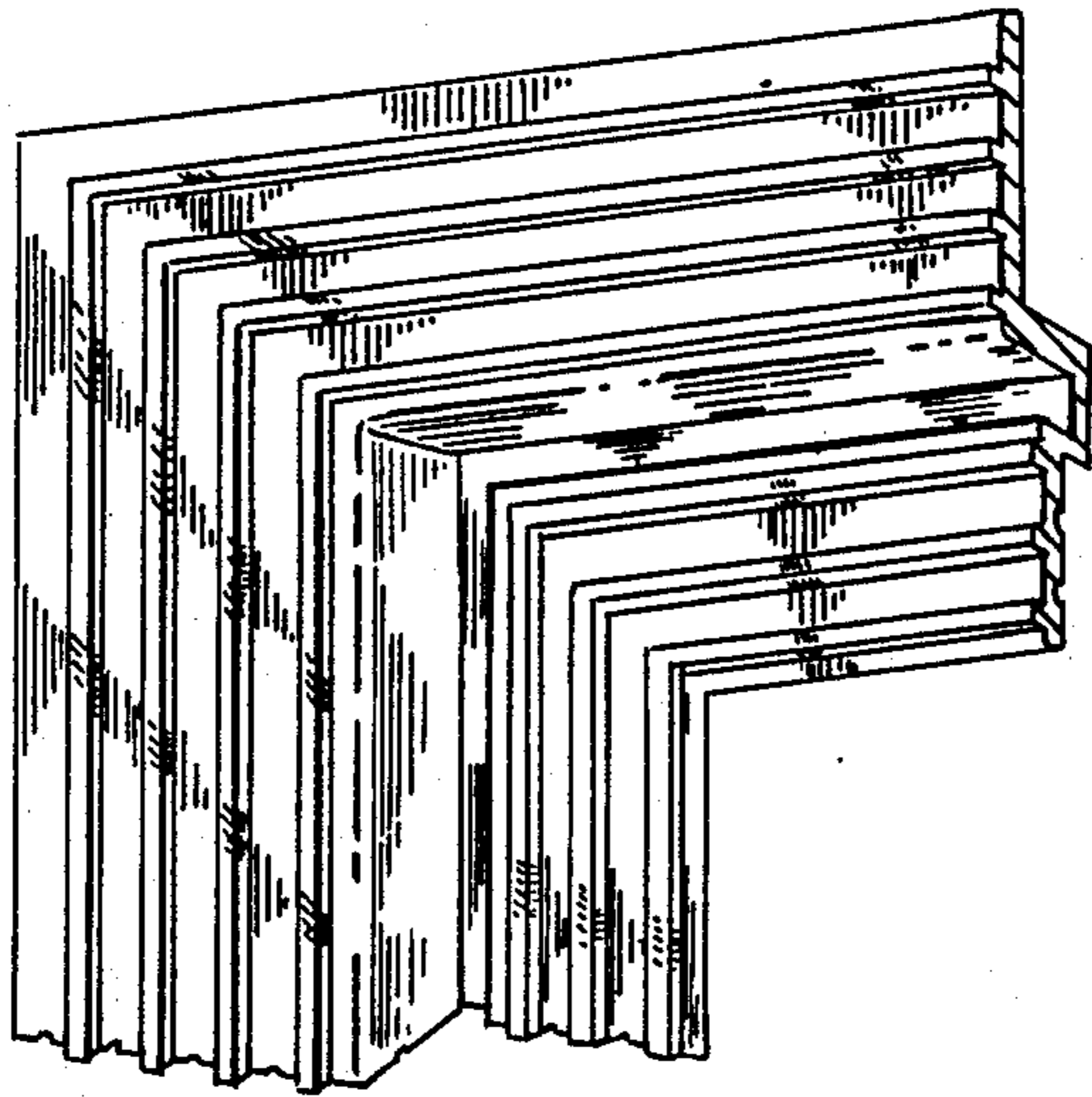

FIG. 6

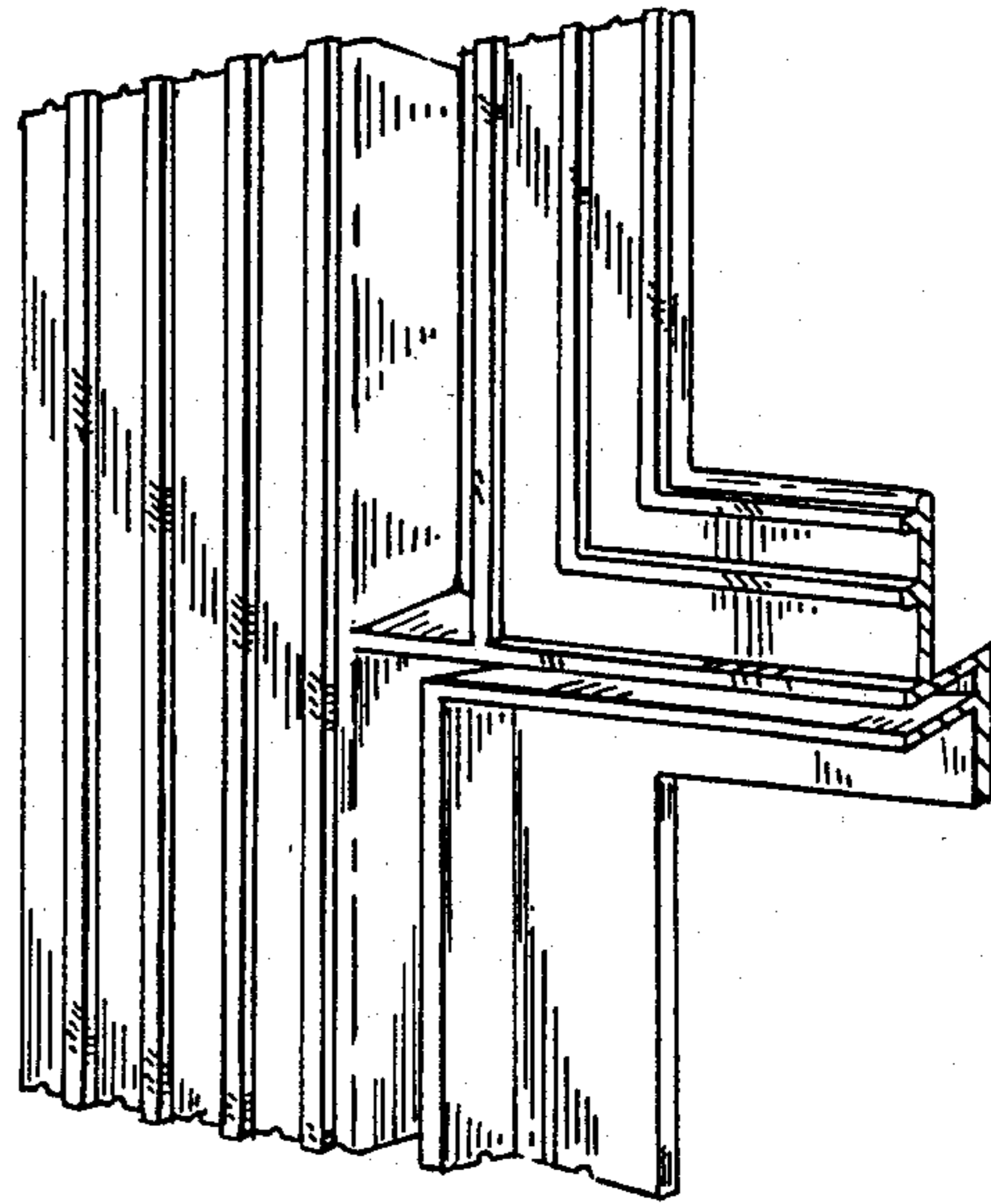

FIG. 8

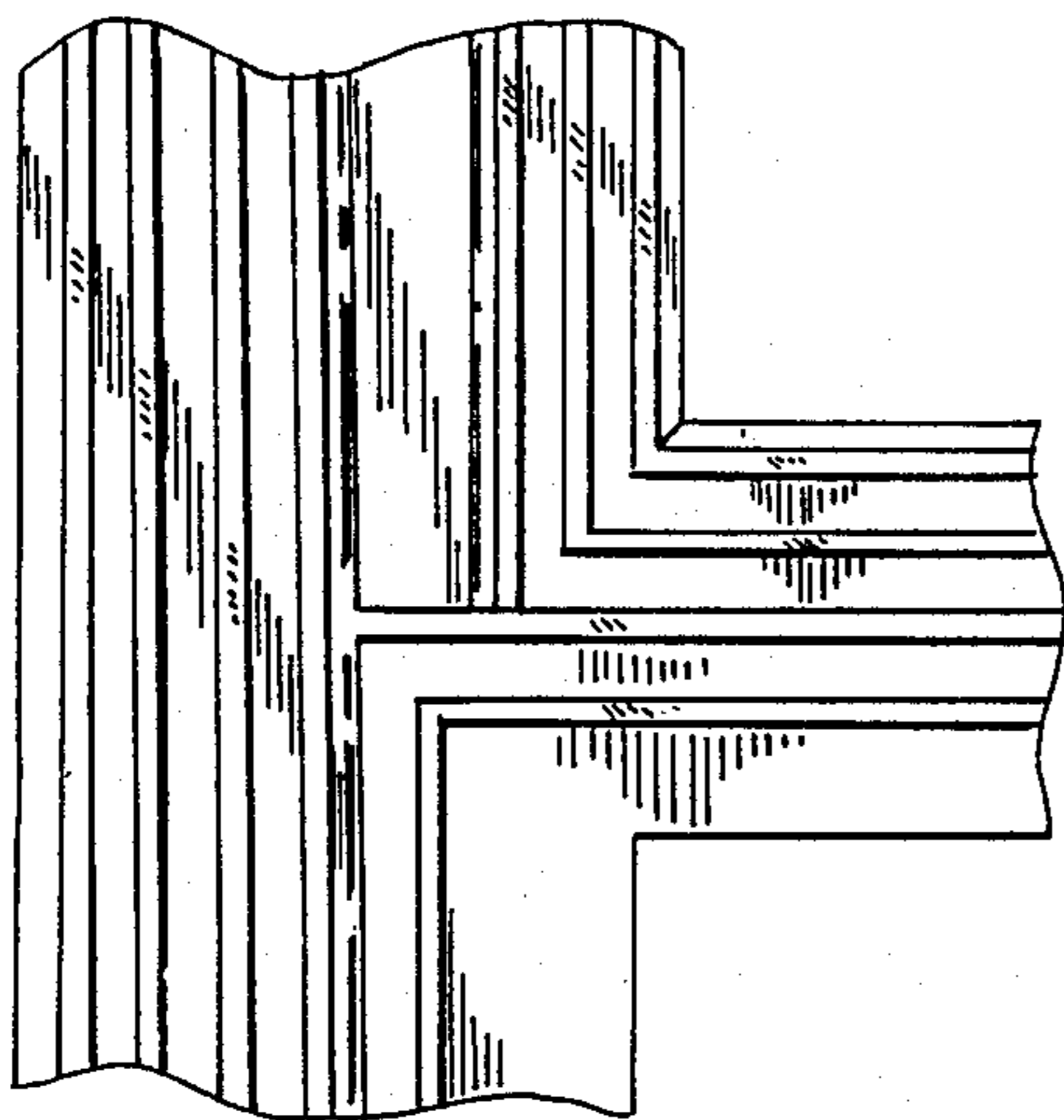

FIG. 9