

# United States Patent [19]

Ogawa et al.

[11] Patent Number: **Des. 304,946**

[45] Date of Patent: **\*\* Dec. 5, 1989**

[54] **TRANSMITTER AND RECEIVER FOR MICROWAVE COMMUNICATIONS**

[75] Inventors: **Shigeo Ogawa; Yoshio Minowa**, both of Tokyo, Japan

[73] Assignee: **NEC Corporation**, Tokyo, Japan

[\*\*] Term: **14 Years**

[21] Appl. No.: **278,310**

[22] Filed: **Nov. 30, 1988**

[30] **Foreign Application Priority Data**

May 30, 1988 [JP] Japan ..... 63-21467

[52] U.S. Cl. .... **D14/231; D14/230**

[58] Field of Search ..... **D14/230-238;**  
343/720, 721, 730, 741, 746, 747, 748, 805, 806,  
815, 820, 872, 873, 907, 908, 909

[56] **References Cited**

## U.S. PATENT DOCUMENTS

D. 212,849 12/1968 Miller ..... D14/230

D. 283,129 3/1986 Fourcher et al. .... D14/230

D. 288,202 2/1987 Fuhrman et al. .... D14/230

D. 288,322 2/1987 Goodman et al. .... D14/230

D. 293,573 1/1988 Nakayama ..... D14/231

D. 293,575 1/1988 Sugiura ..... D14/230

*Primary Examiner*—Bernard Ansher

*Assistant Examiner*—Theodore M. Shooman

*Attorney, Agent, or Firm*—Sughrue, Mion, Zinn,  
Macpeak & Seas

[57] **CLAIM**

The ornamental design for a transmitter and receiver for microwave communications, as shown.

## DESCRIPTION

FIG. 1 is a right side elevational view of a transmitter and receiver for microwave communications showing our new design;

FIG. 2 is a top plan view thereof;

FIG. 3 is a left side elevational view thereof;

FIG. 4 is a front elevational view thereof;

FIG. 5 is a rear elevational view thereof;

FIG. 6 is a bottom plan view thereof; and

FIG. 7 is a rear, top and right side perspective view thereof.

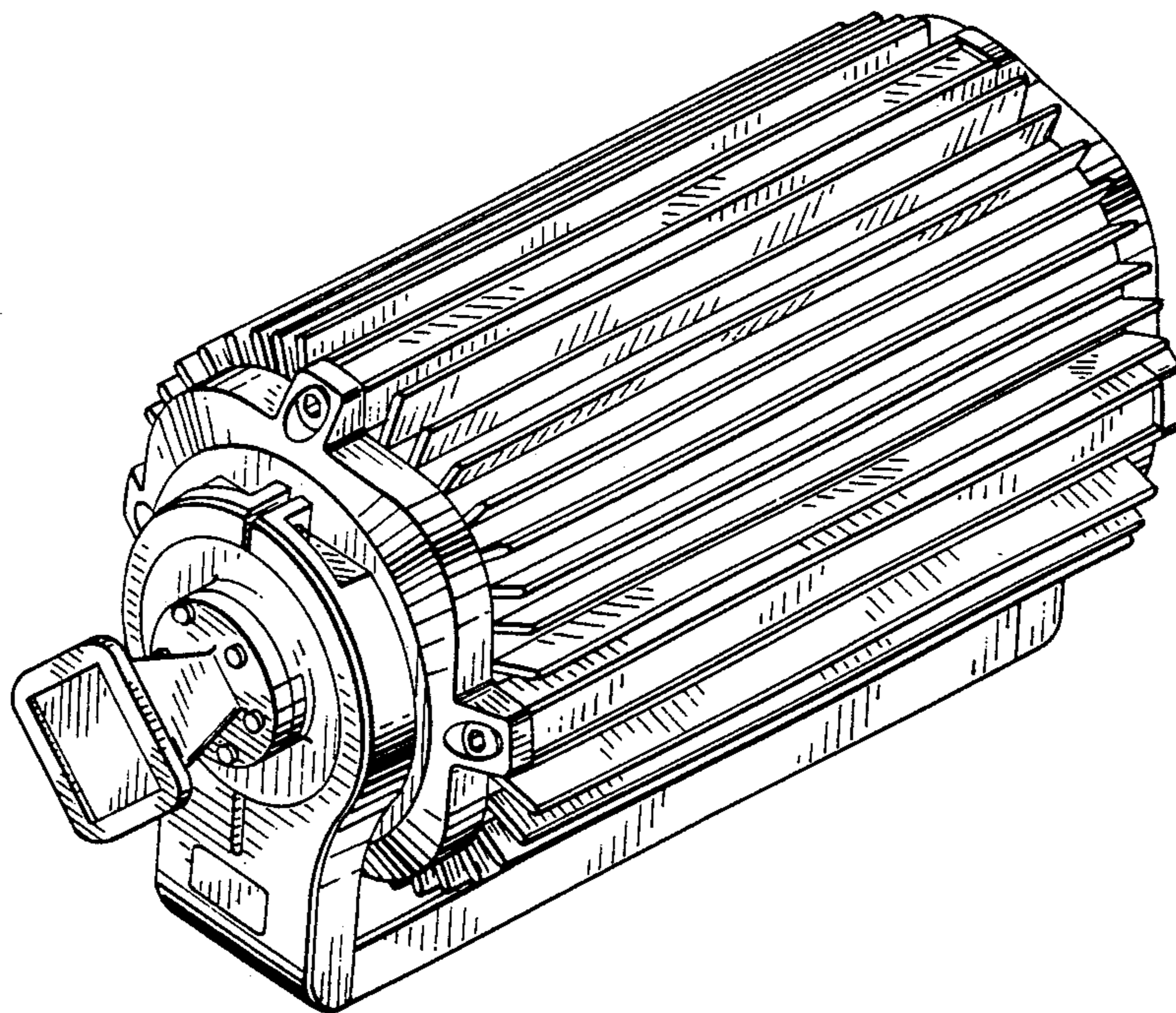

FIG. 2

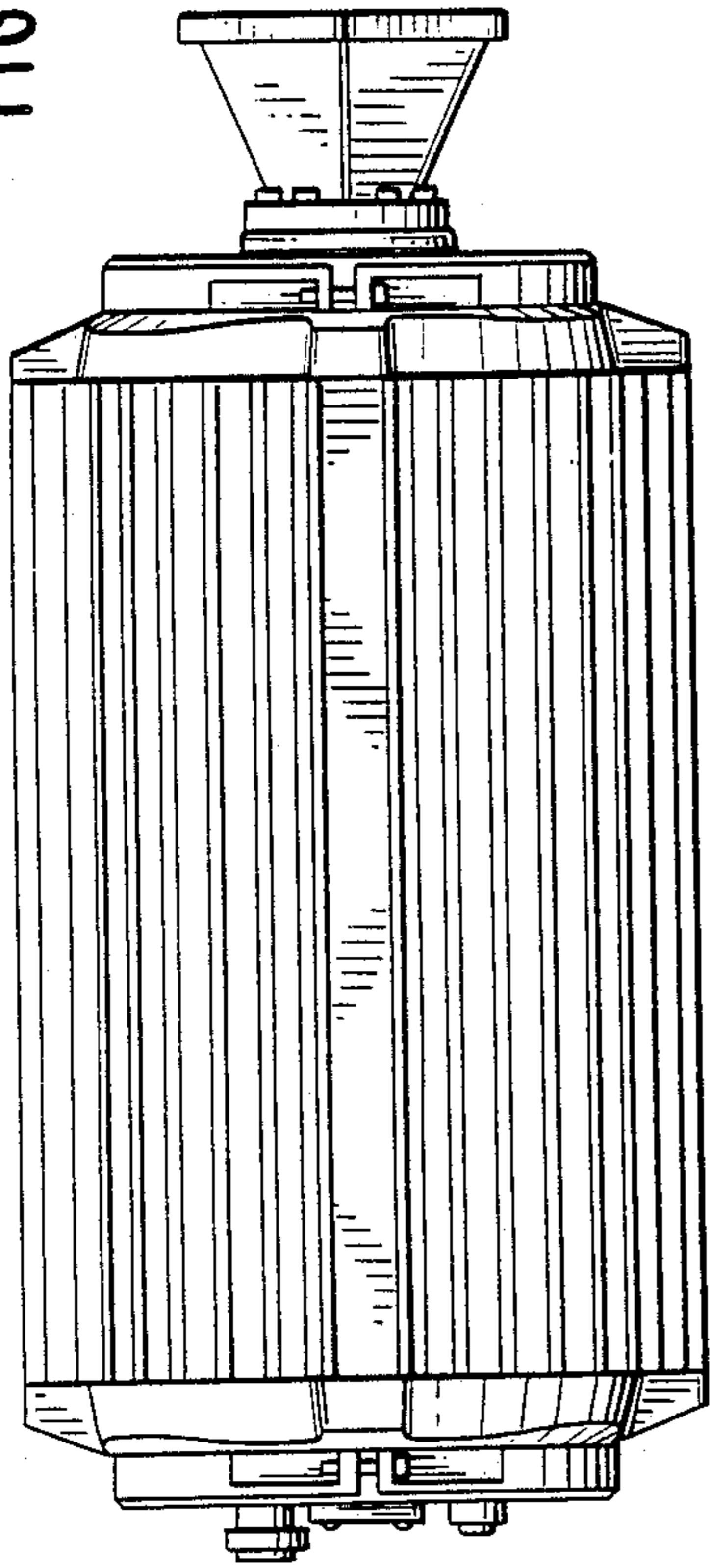

FIG. 4

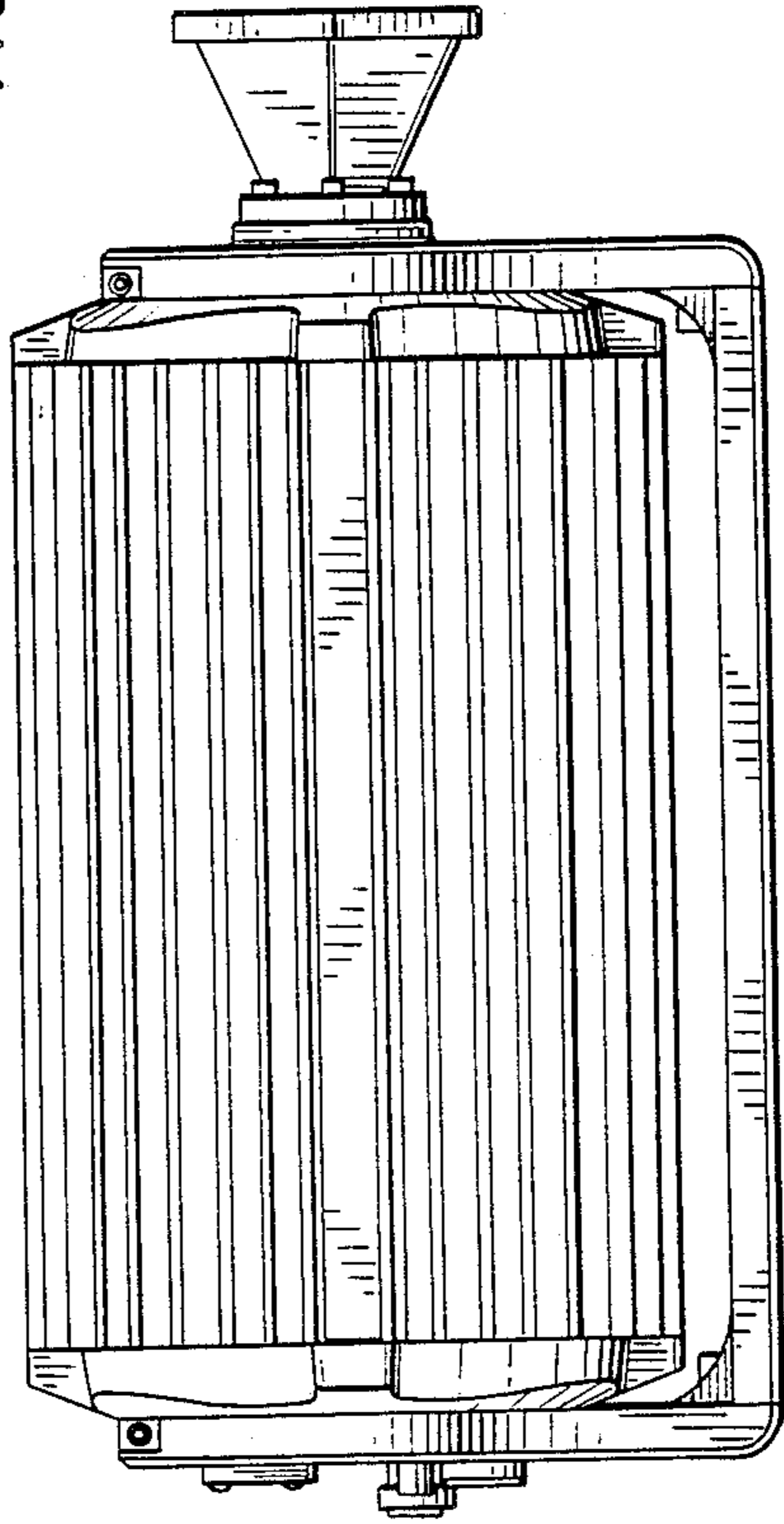

FIG. 1

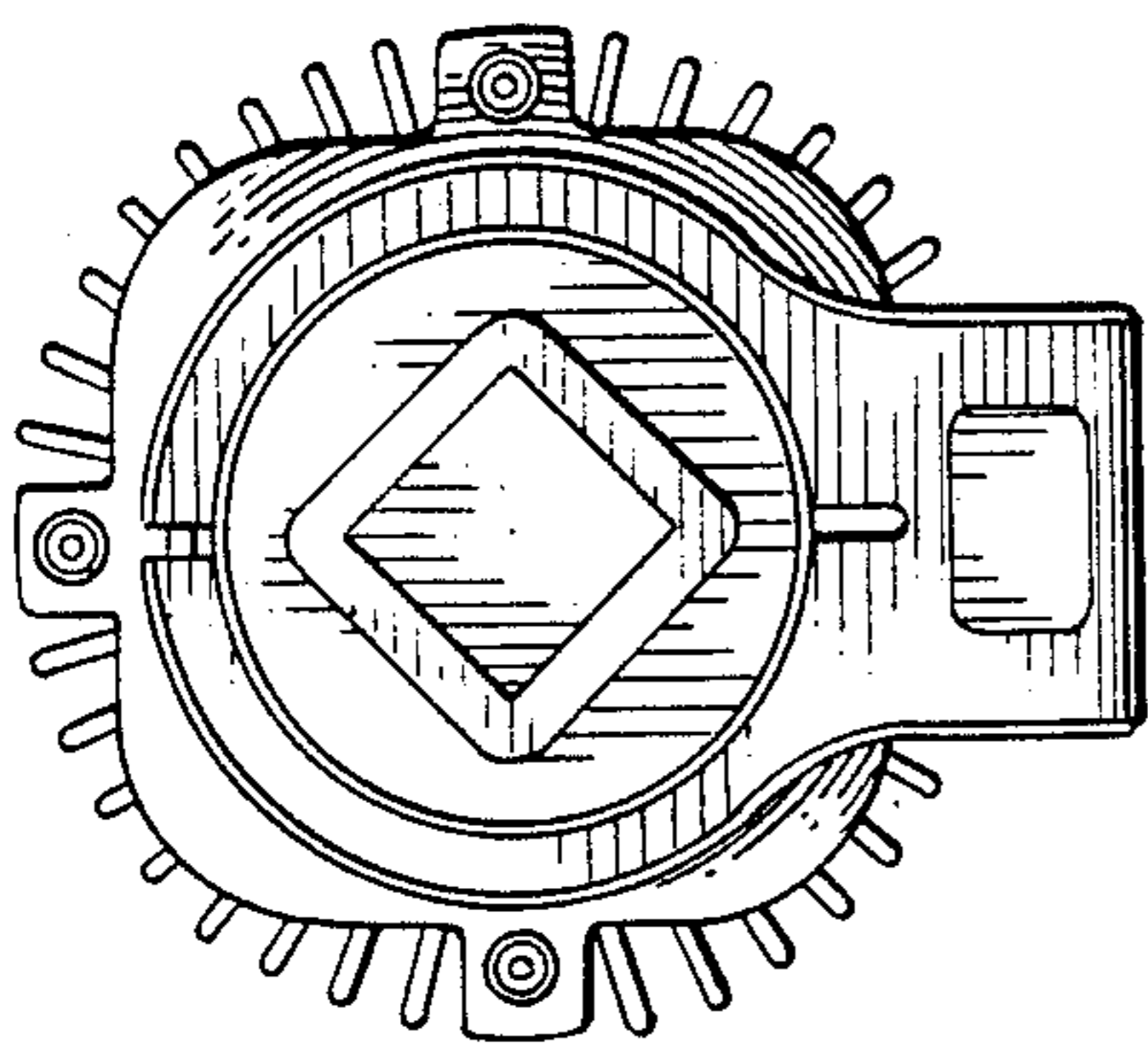

FIG. 3

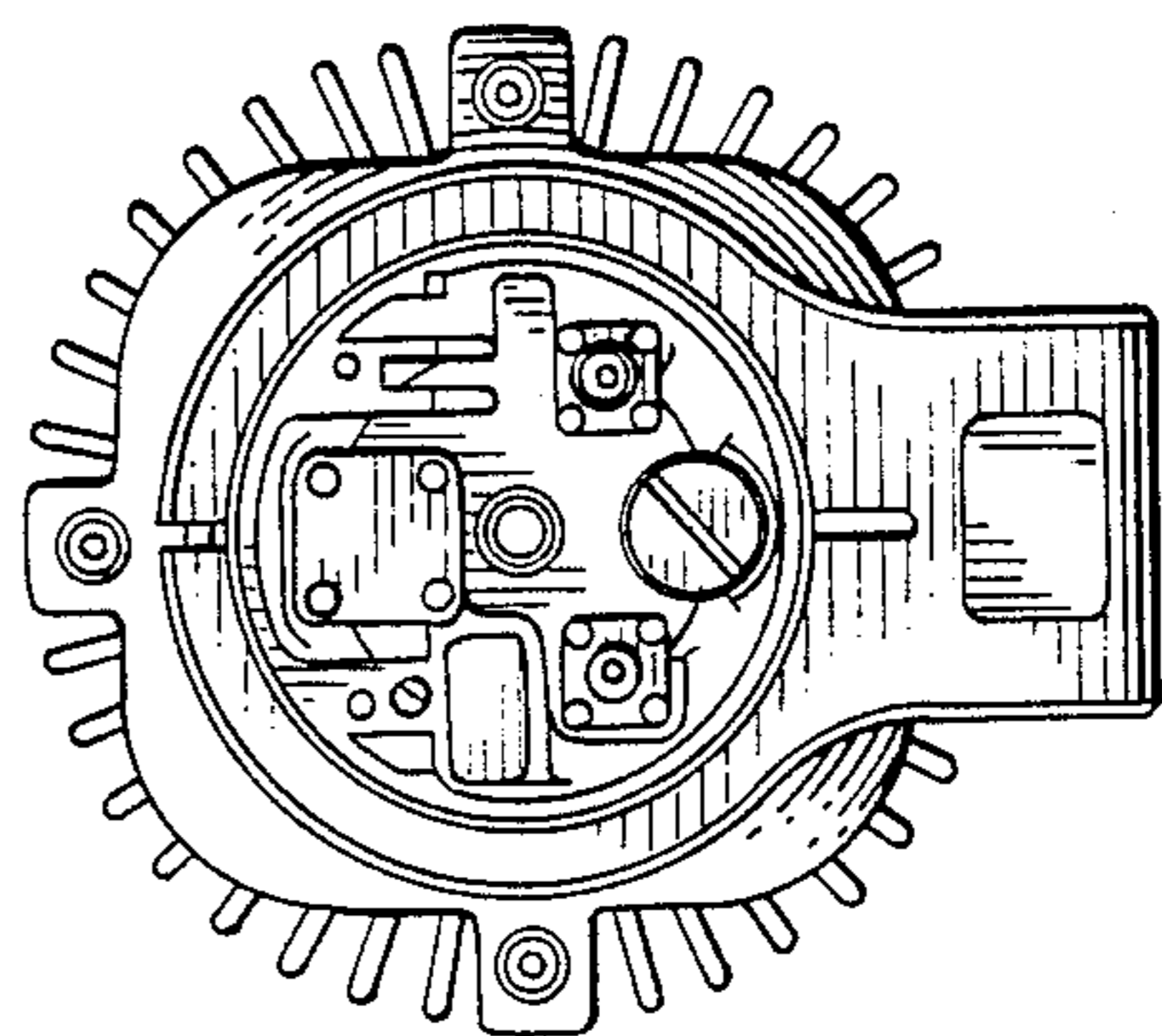

FIG. 5

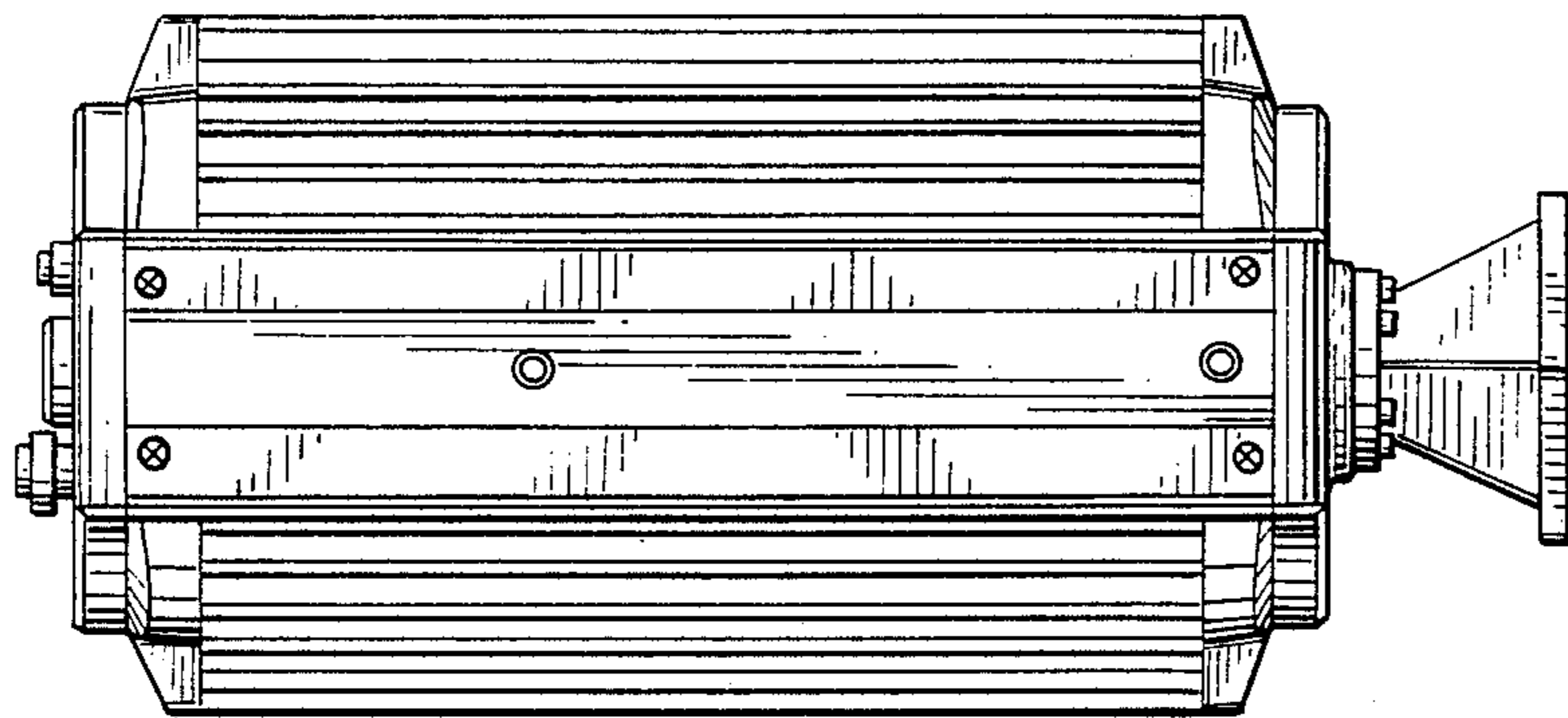
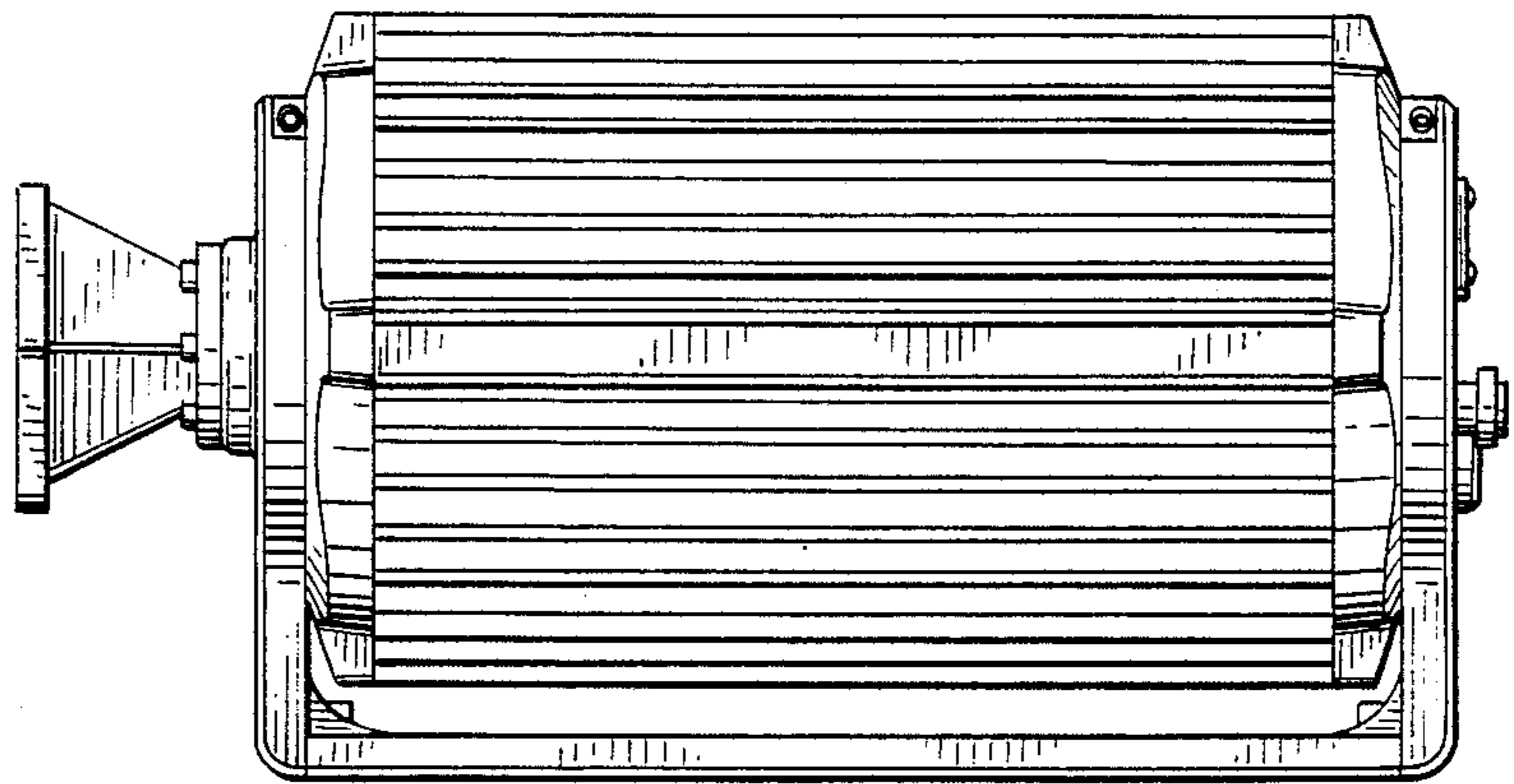

FIG. 6

FIG. 7

