

[54] TRANSMISSION AND RECEPTION UNIT FOR A MINI EARTH STATION

[75] Inventors: Yuhei Kosugi; Yoshio Minowa, both of Tokyo, Japan

[73] Assignee: NEC Corporation, Tokyo, Japan

[\*\*] Term: 14 Years

[21] Appl. No.: 16,142

[22] Filed: Feb. 18, 1987

[30] Foreign Application Priority Data

Aug. 18, 1986 [JP] Japan ..... 61-32109

[52] U.S. Cl. .... D14/231; D14/230

[58] Field of Search ..... D14/230-238; 343/720, 721, 730, 741, 746, 747, 748, 805, 806, 815, 820, 872, 873, 907, 908, 909

[56] References Cited

U.S. PATENT DOCUMENTS

- D. 212,849 12/1969 Miller ..... D14/230
- D. 283,129 3/1986 Fourcher et al. .... D14/230
- D. 288,202 2/1987 Fuhrman et al. .... D14/230
- D. 288,322 2/1987 Goodman et al. .... D14/230
- D. 293,573 1/1988 Nakayama ..... D14/231
- D. 293,575 1/1988 Sugiura ..... D14/230

OTHER PUBLICATIONS

M/A-Com, Apr. 1986.

Clearlink, Unknown.

Starcom Equatorial Assumed publication dates are prior to Japanese priority application date of Aug. 18, 1986.

Primary Examiner—Bernard Ansher

Assistant Examiner—Theodore M. Shooman

Attorney, Agent, or Firm—Sughrue, Mion, Zinn,

Macpeak & Seas

[57] CLAIM

The ornamental design for a transmission and reception unit for a mini earth station, as shown.

DESCRIPTION

FIG. 1 is a right side elevational view of a transmission and reception unit for a mini earth station showing our new design;

FIG. 2 is a left side elevational view thereof;

FIG. 3 is a top plan view thereof;

FIG. 4 is a front elevational view thereof;

FIG. 5 is a bottom plan view thereof;

FIG. 6 is a rear elevational view thereof; and

FIG. 7 is a top, rear and right side perspective view thereof.

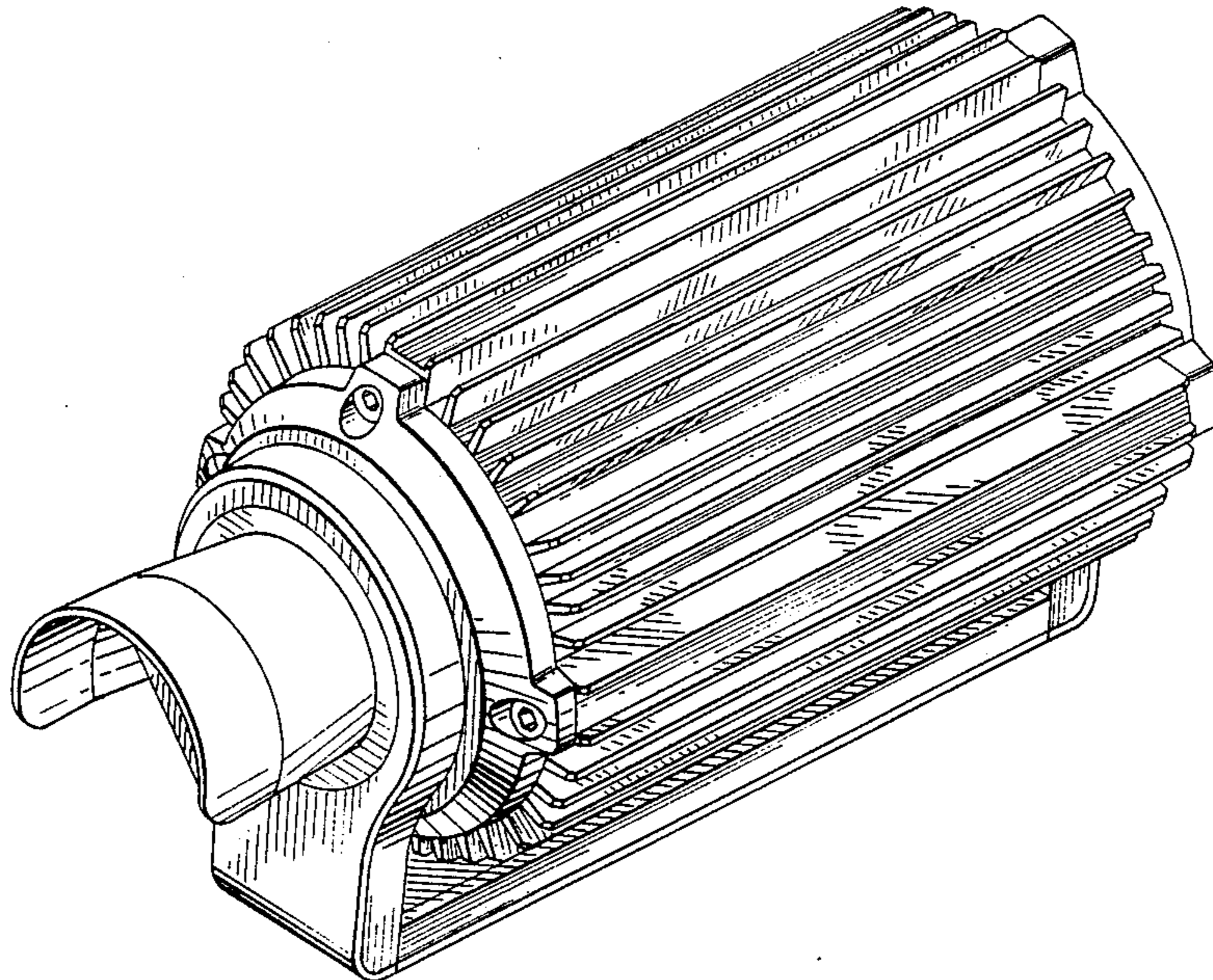

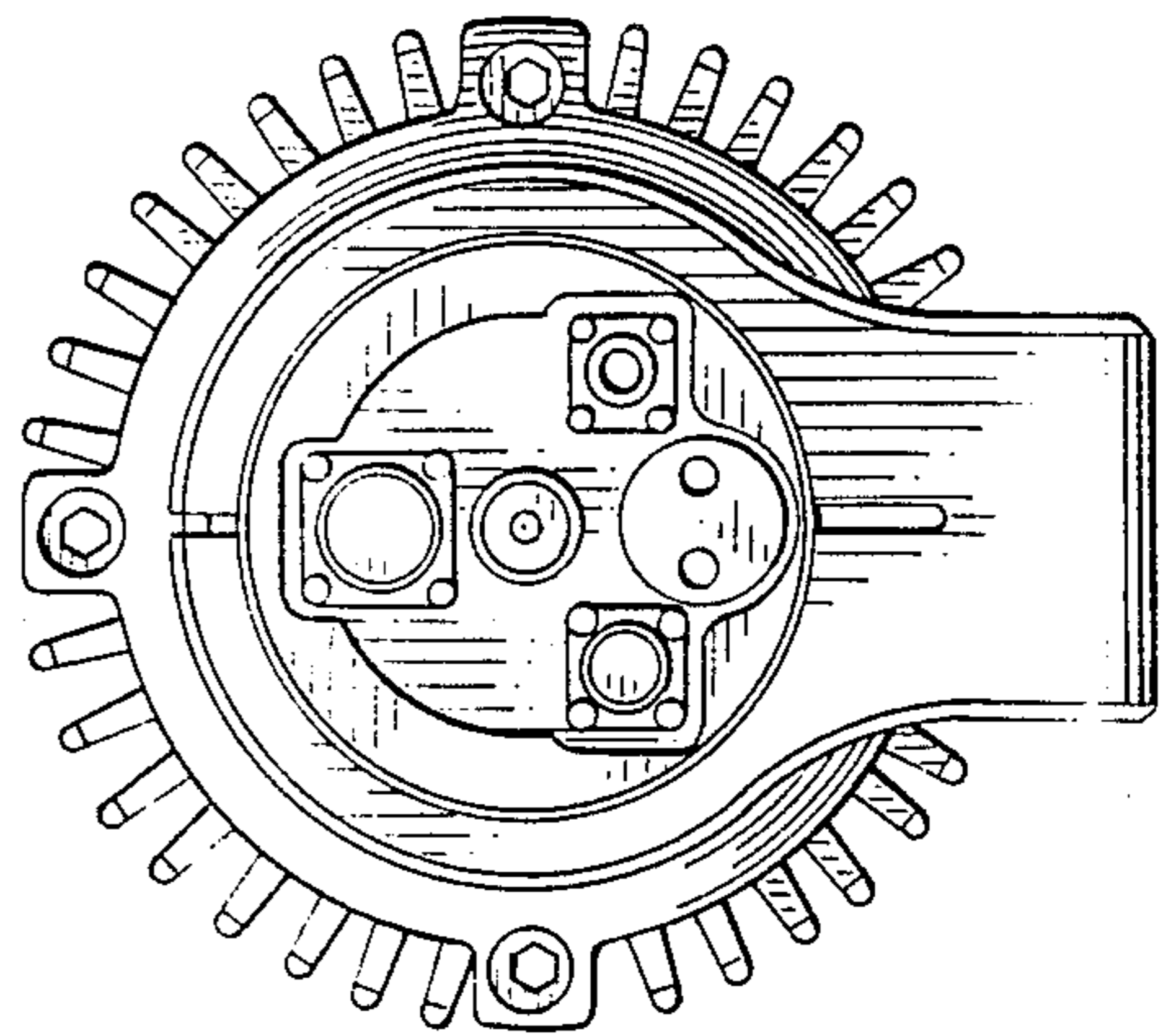
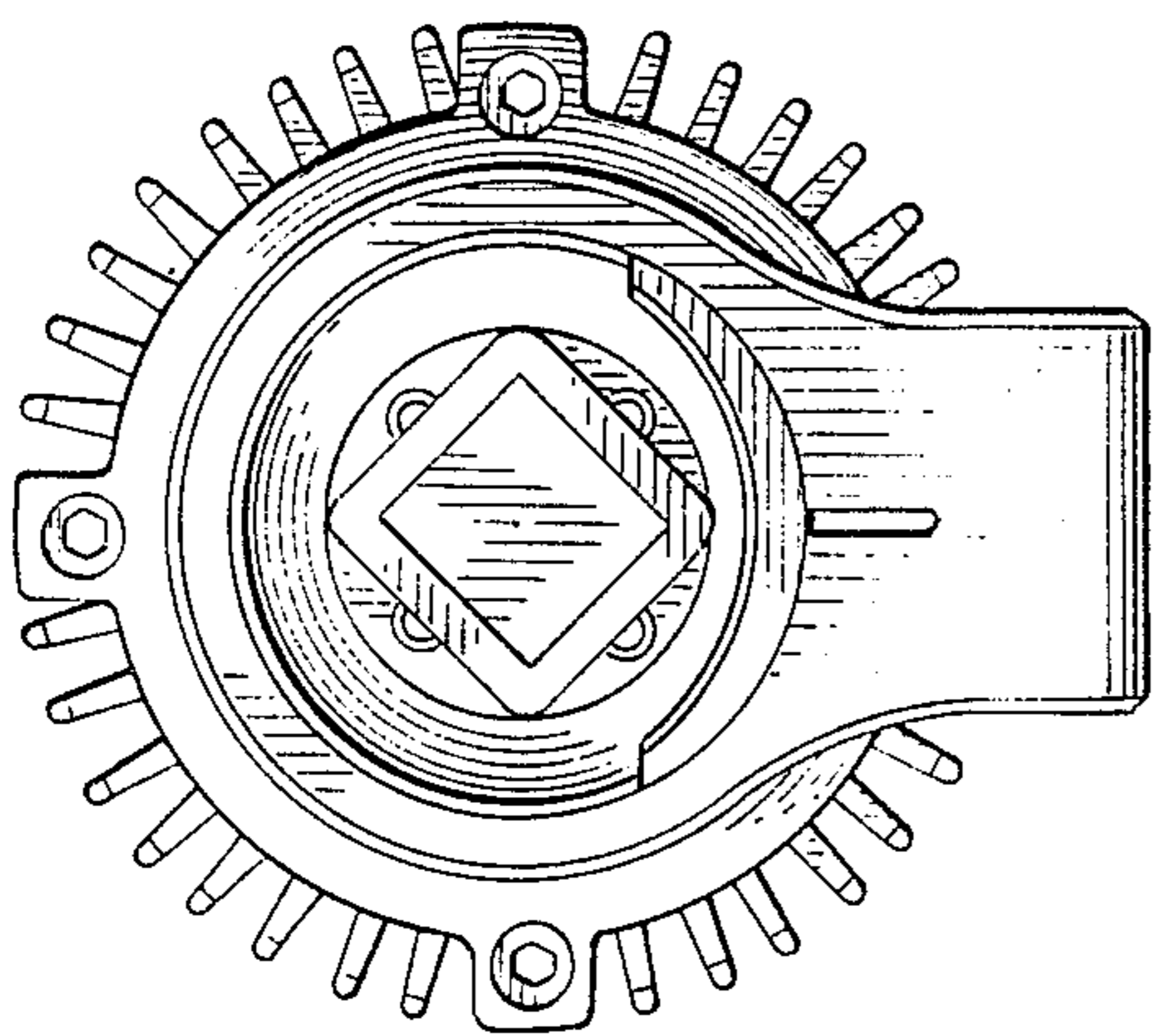
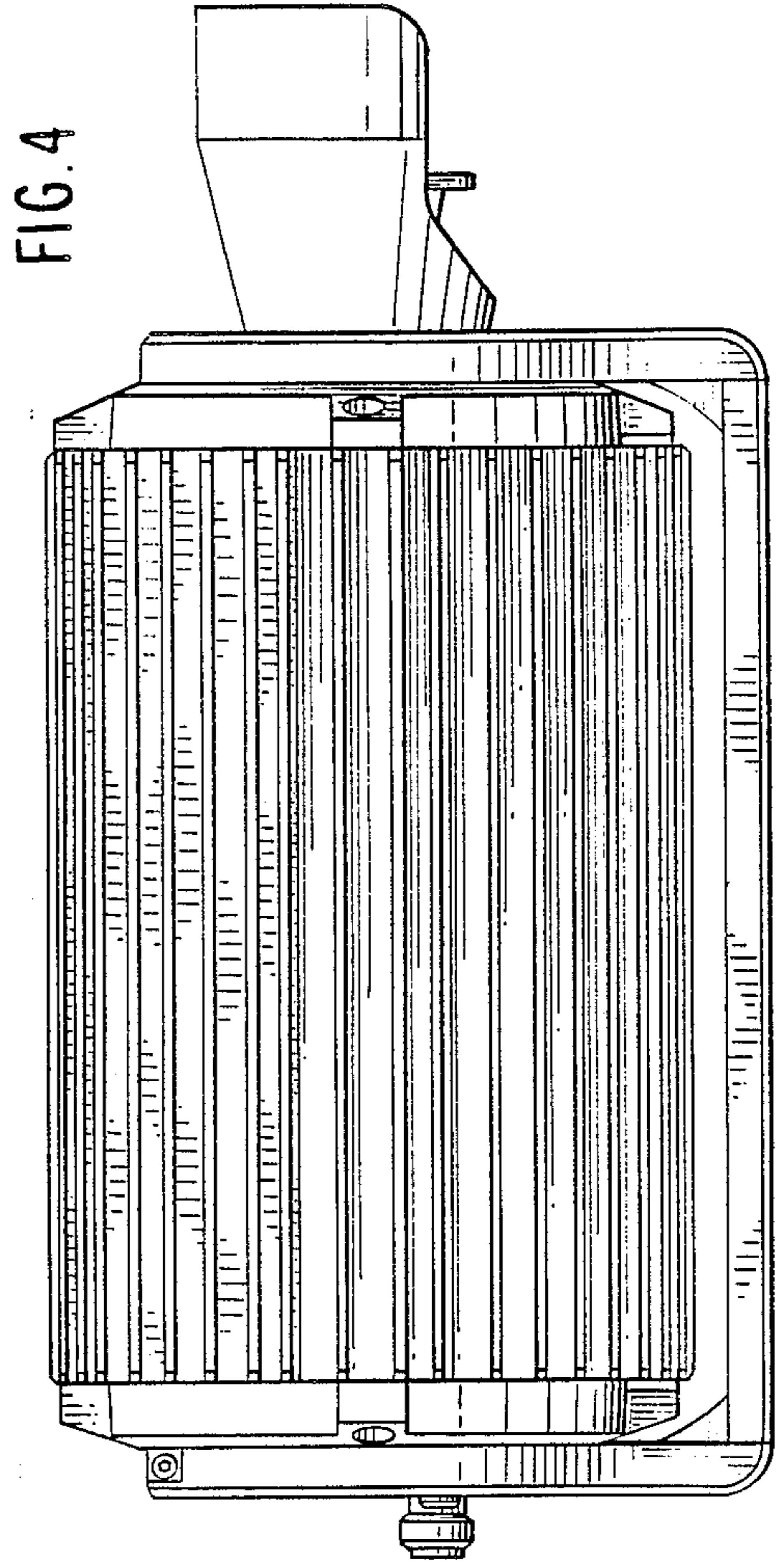
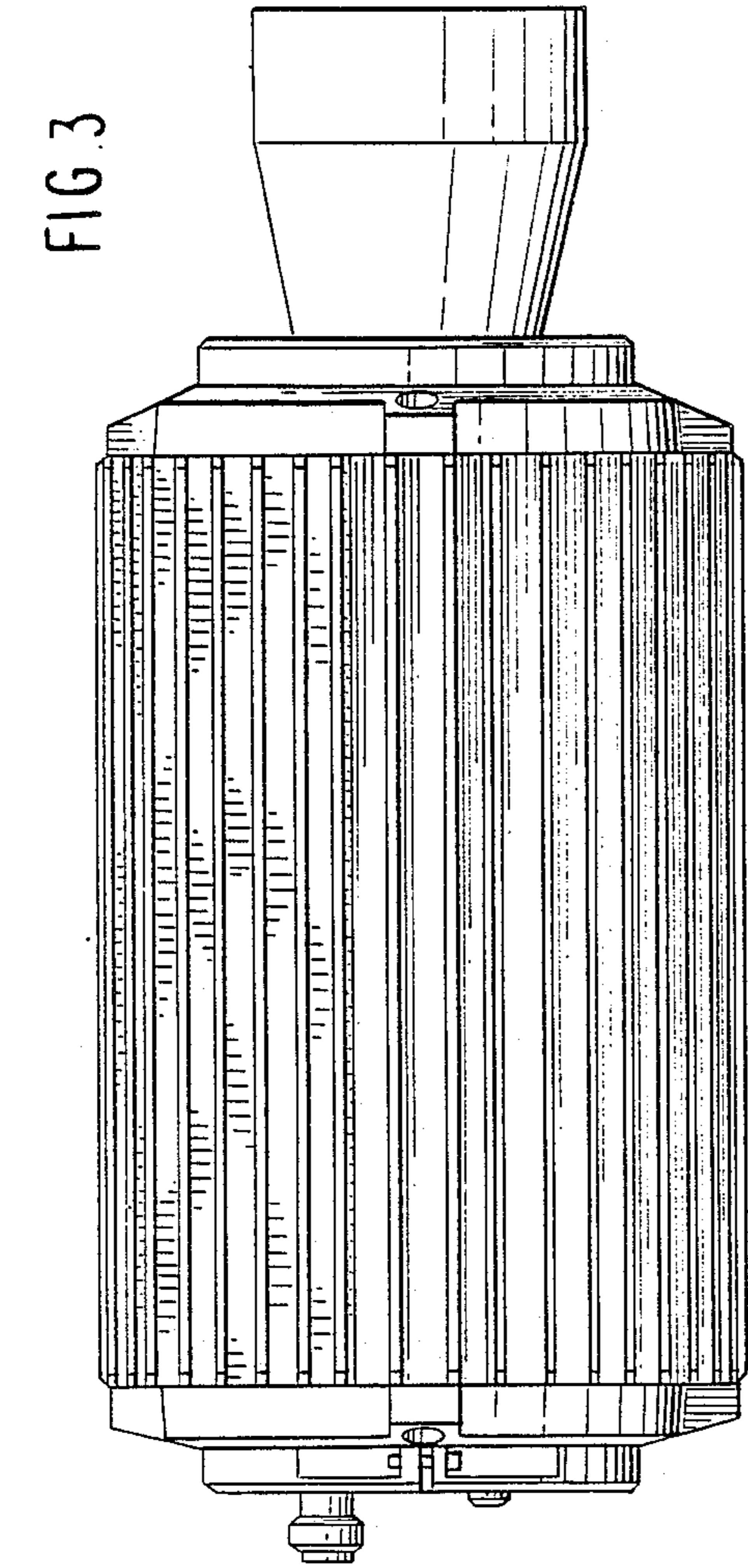

FIG. 1

FIG. 2

FIG. 5

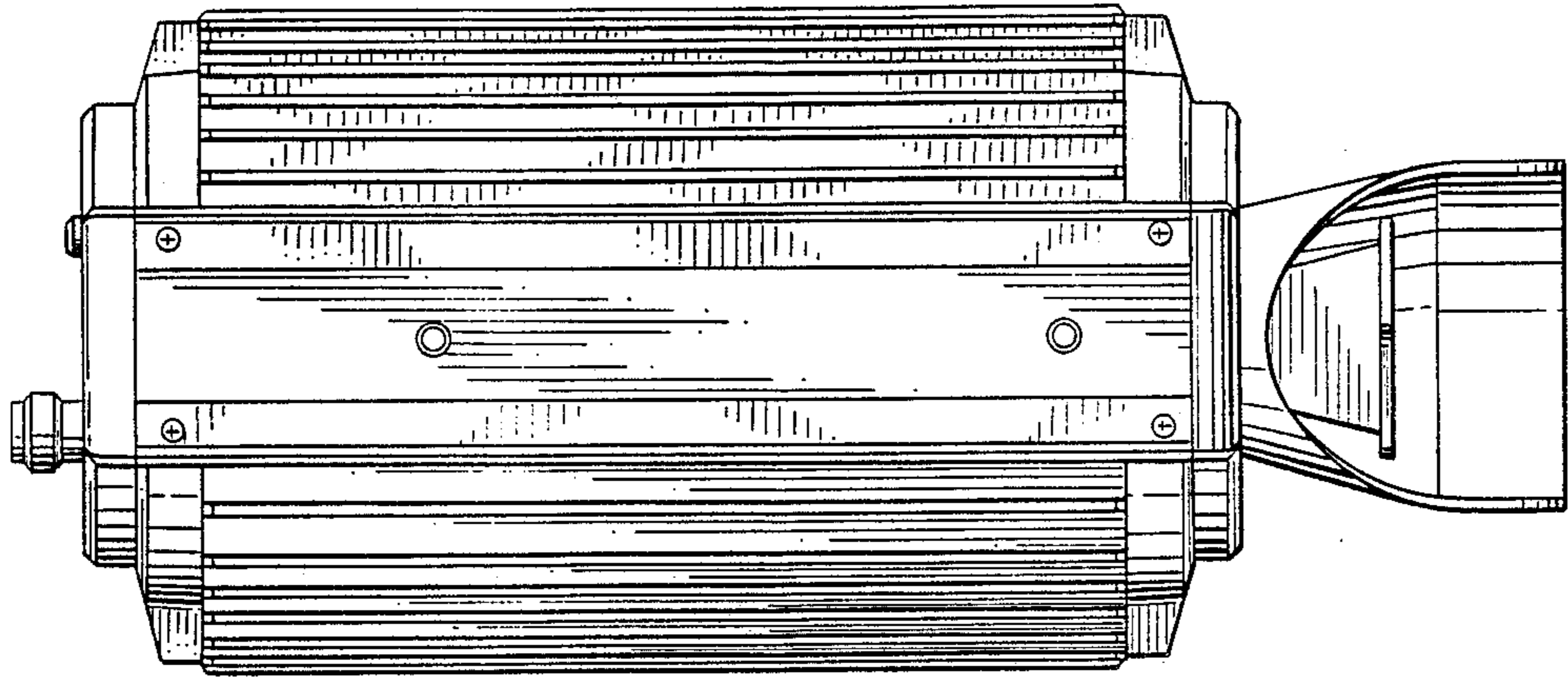

FIG. 6

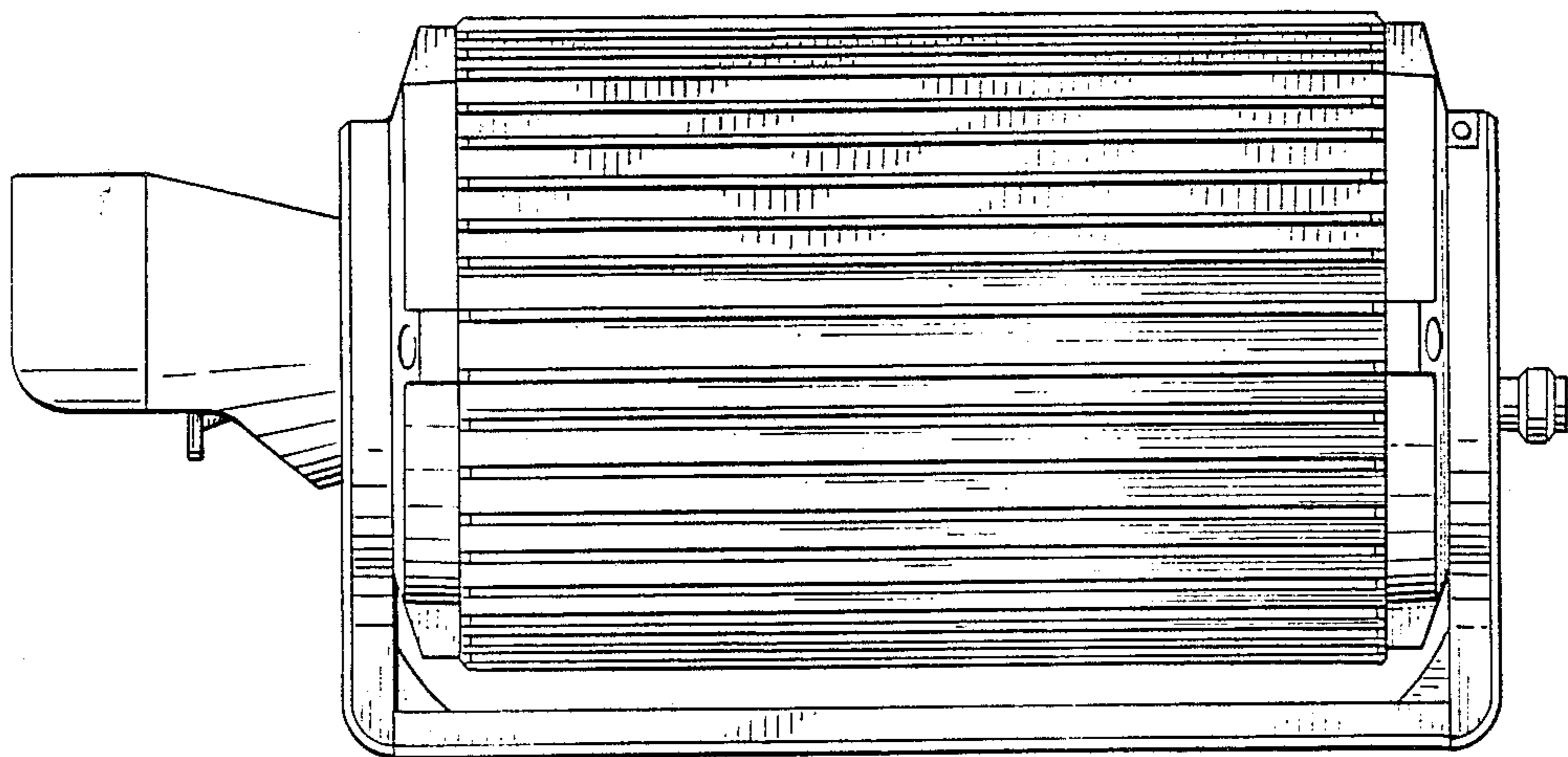

FIG. 7

