

[54] **SAILBOAT HULL**

[76] **Inventor: Bruce Kirby, 213 Rowayton Ave., Rowayton, Conn. 06853**

[**] **Term: 14 Years**

[21] **Appl. No.: 114,523**

[22] **Filed: Oct. 28, 1987**

[52] **U.S. Cl. D12/303; D12/300**

[58] **Field of Search D12/300, 303, 312; 114/39.1, 39.2, 61**

[56] **References Cited**

U.S. PATENT DOCUMENTS

D. 218,718	9/1970	Pyle	D12/303
D. 265,475	7/1982	Pape	D12/303
3,291,088	12/1966	Klose	114/39.1
4,492,175	1/1985	Johnson	114/39.1

Primary Examiner—Wallace R. Burke
Assistant Examiner—Kay H. Chin

Attorney, Agent, or Firm—St. Onge Steward Johnston & Reens

[57] **CLAIM**

The ornamental design for a sailboat hull, as shown and described.

DESCRIPTION

FIG. 1 is a right side elevational view of a sailboat hull showing my new design, the broken lines are for illustrative purposes only and form no part of the claimed design;

FIG. 2 is a top plan view thereof;

FIG. 3 is a left side elevational view thereof;

FIG. 4 is a bottom plan view thereof;

FIG. 5 is a rear elevational view thereof;

FIG. 6 is a front elevational view thereof;

FIG. 7 is an enlarged fragmentary perspective view of the aft portion of the cockpit thereof;

FIG. 8 is a cross sectional view thereof taken along lines 8—8 of FIG. 3;

FIGS 9 through 19 are peripheral outline views thereof taken along lines 9—9 through 19—19 of FIG. 3.

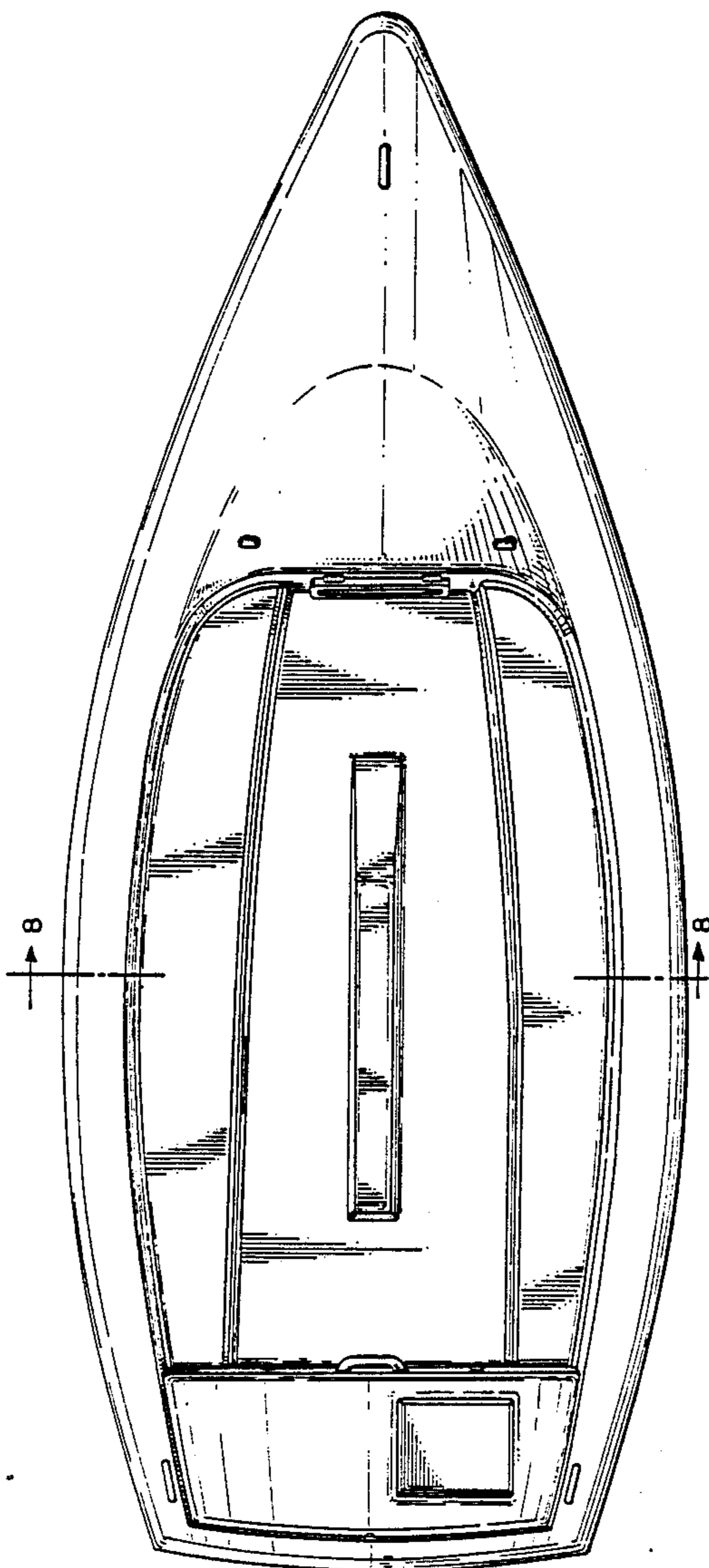

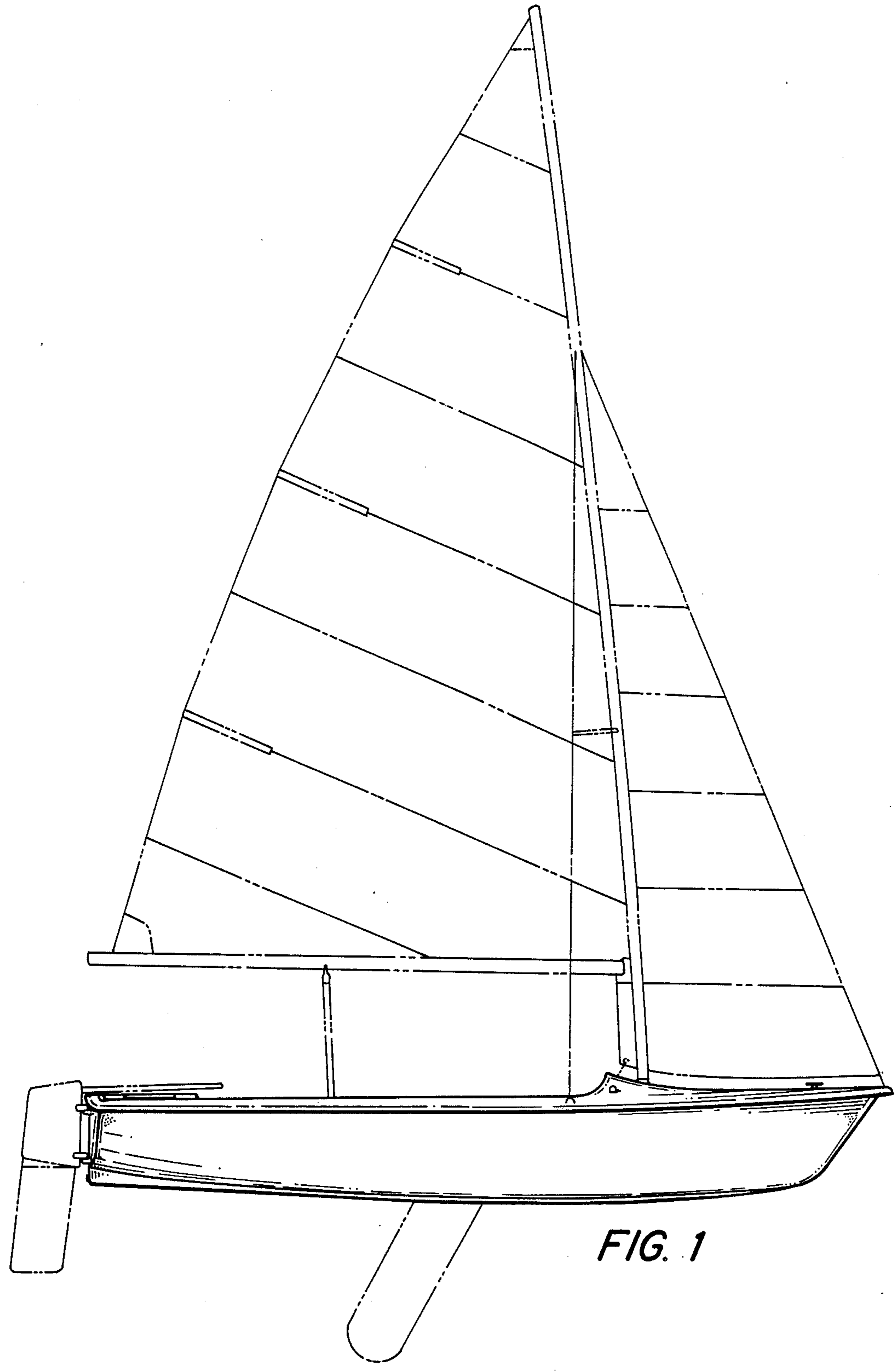

FIG. 1

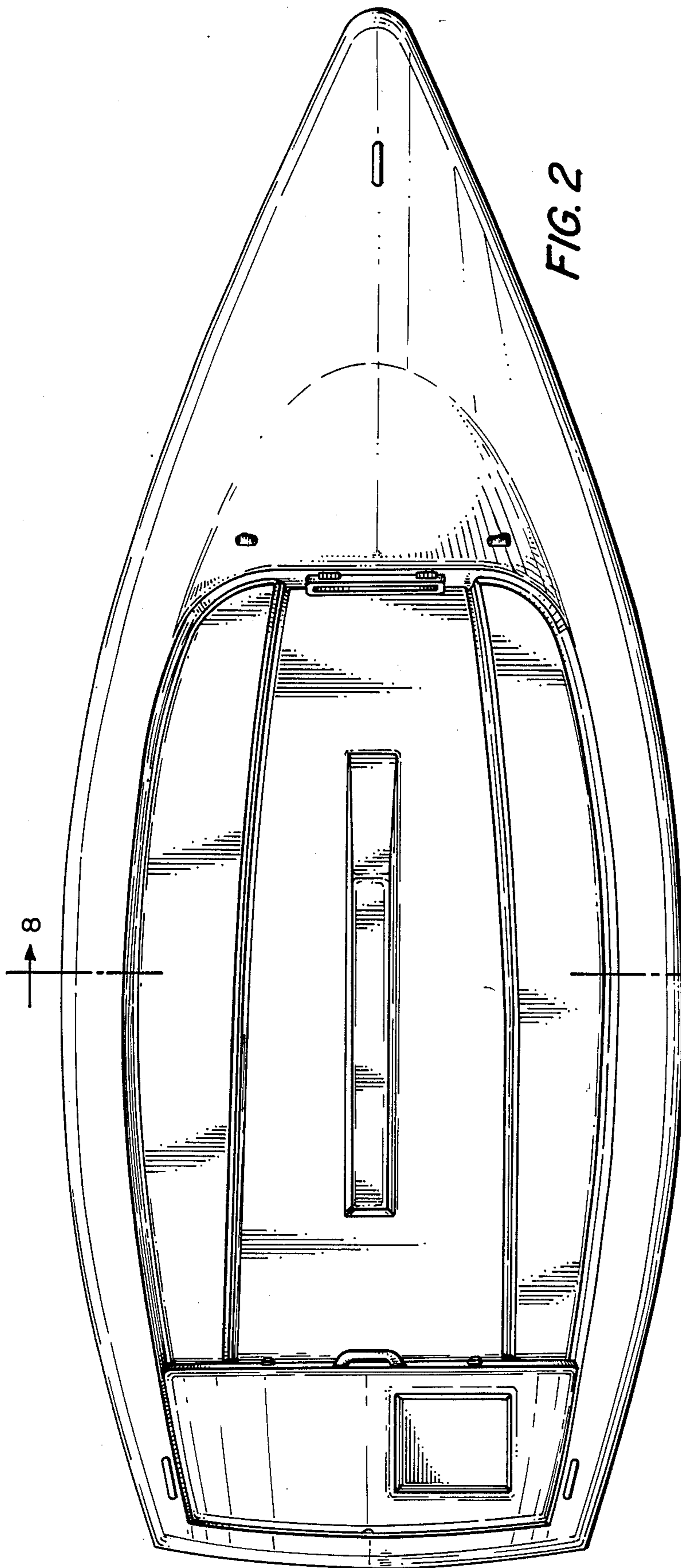

FIG. 2

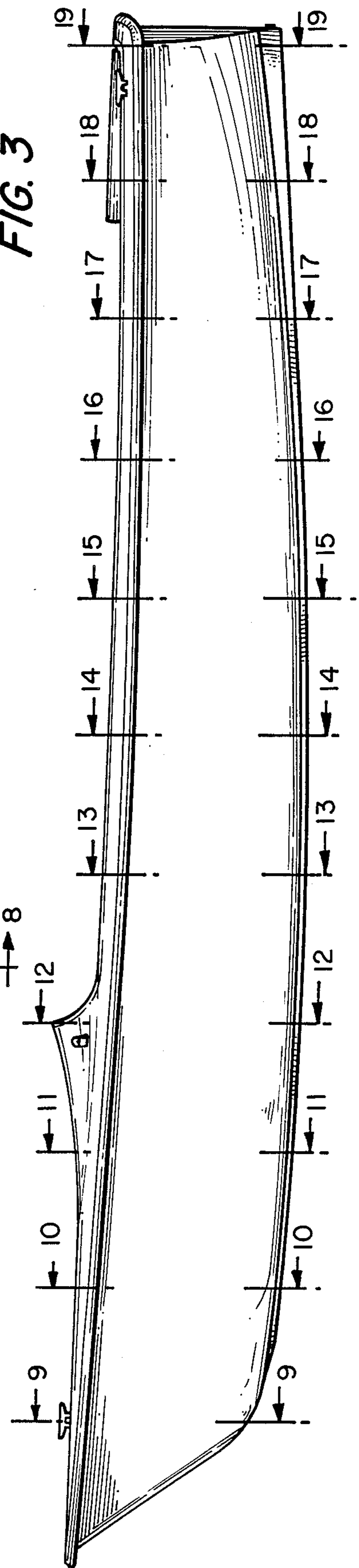

FIG. 3

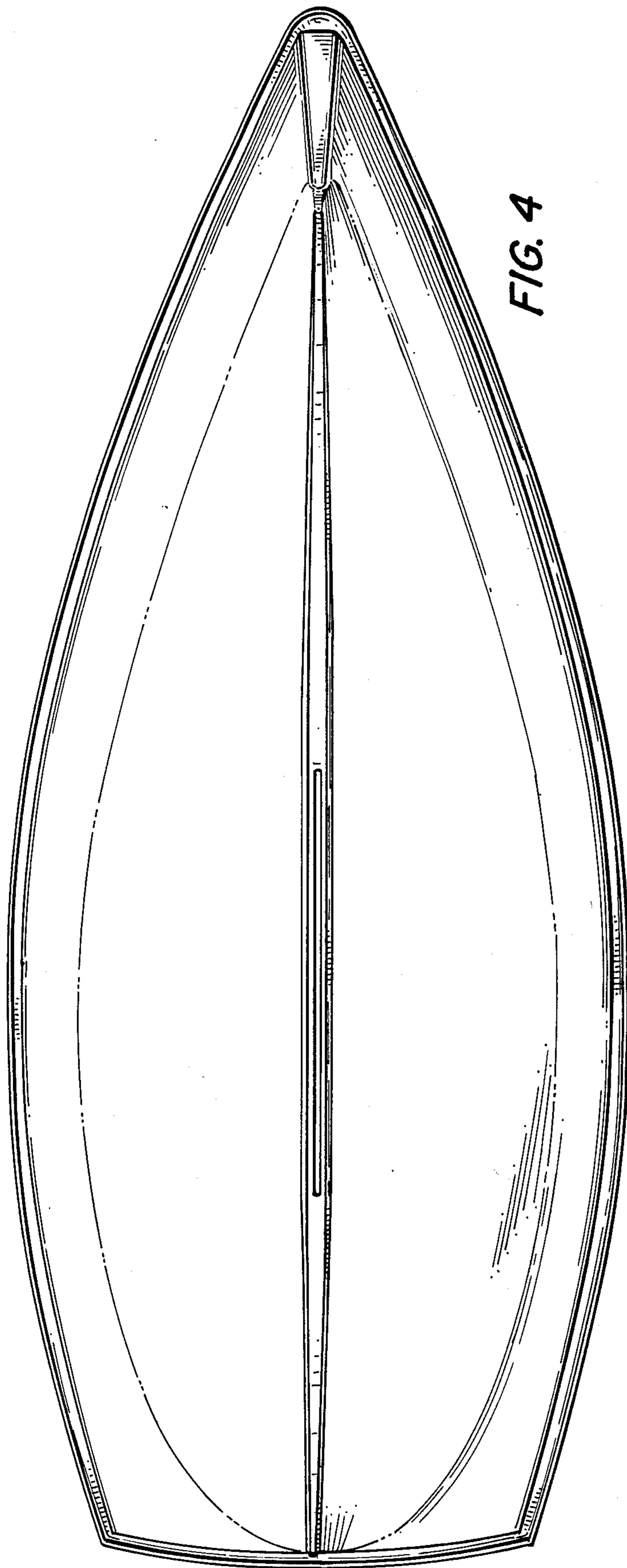

FIG. 4

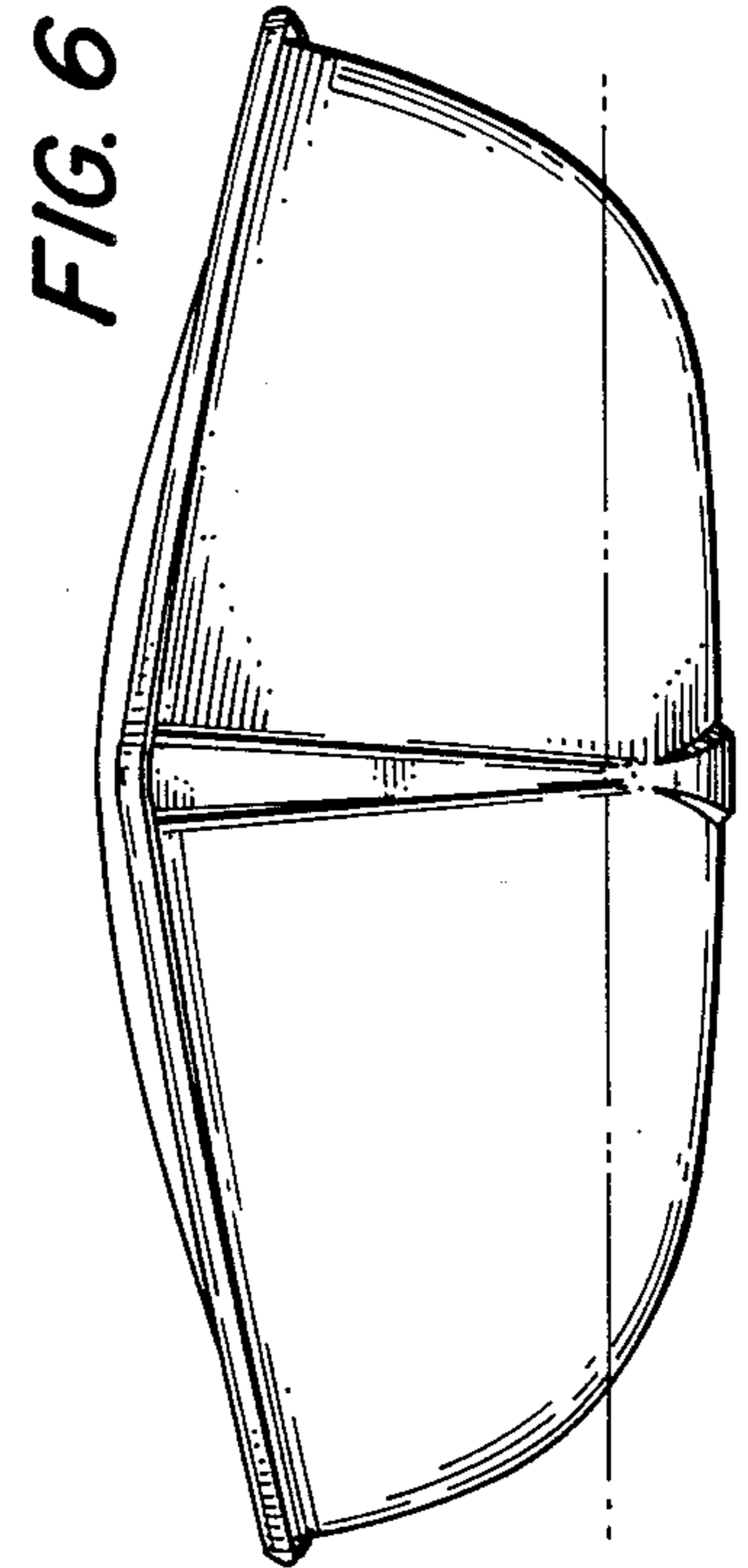

FIG. 6

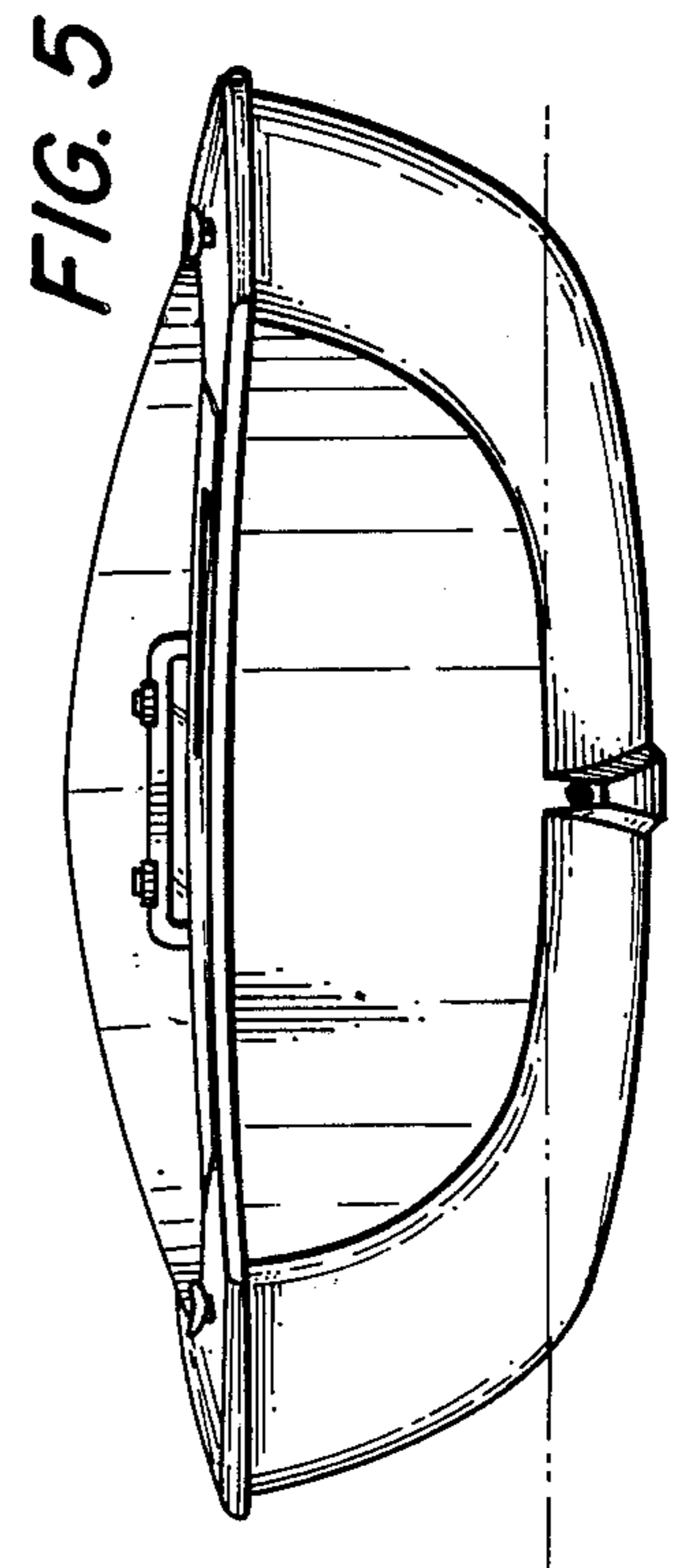

FIG. 5

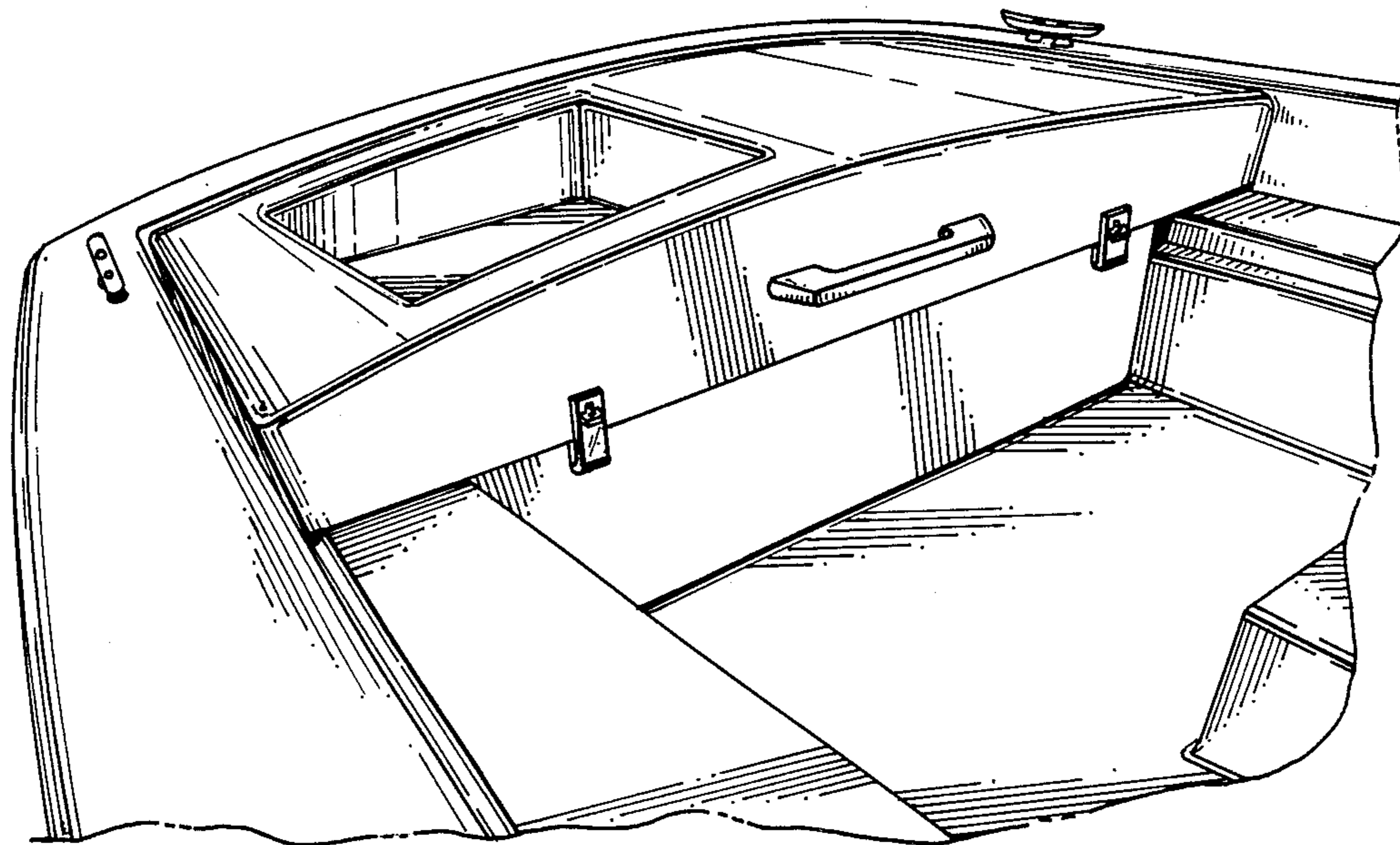

FIG. 7

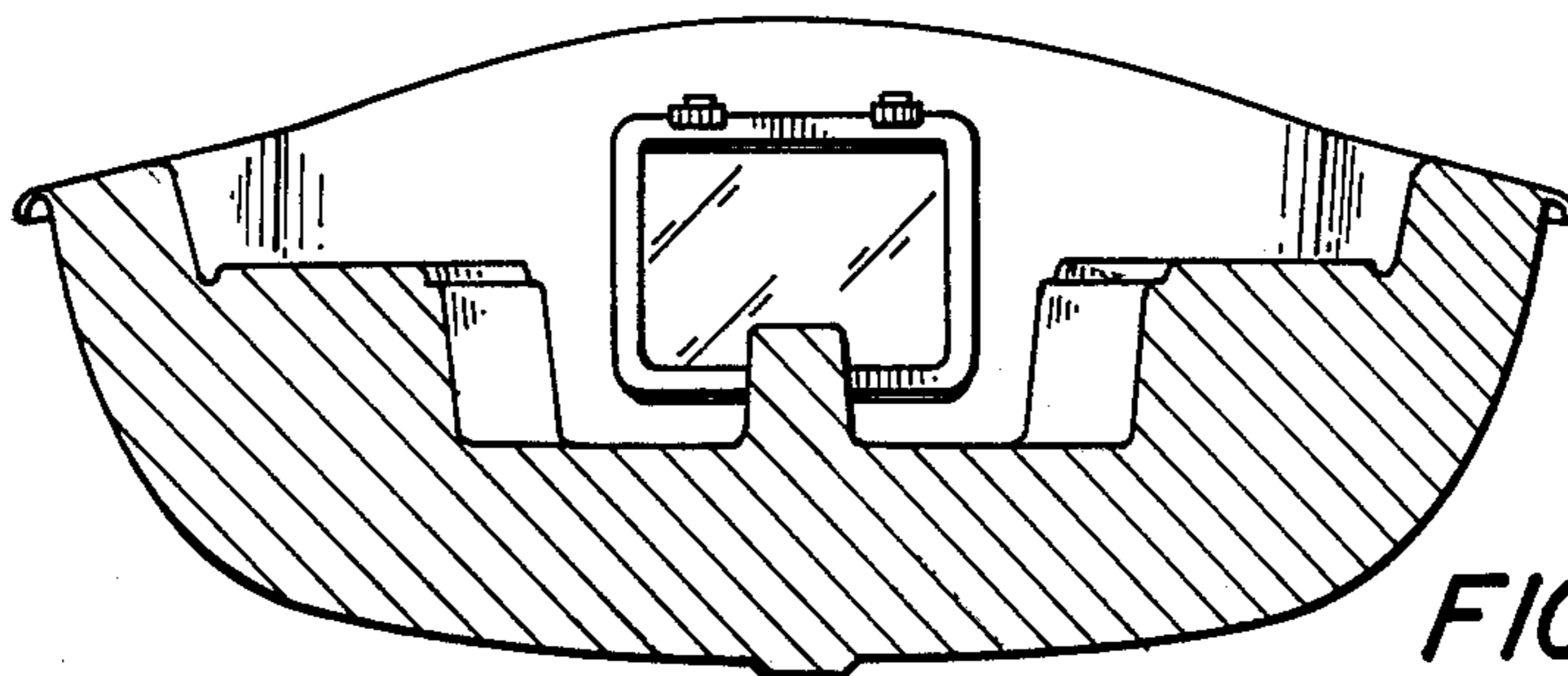

FIG. 8

ROTATED 90°

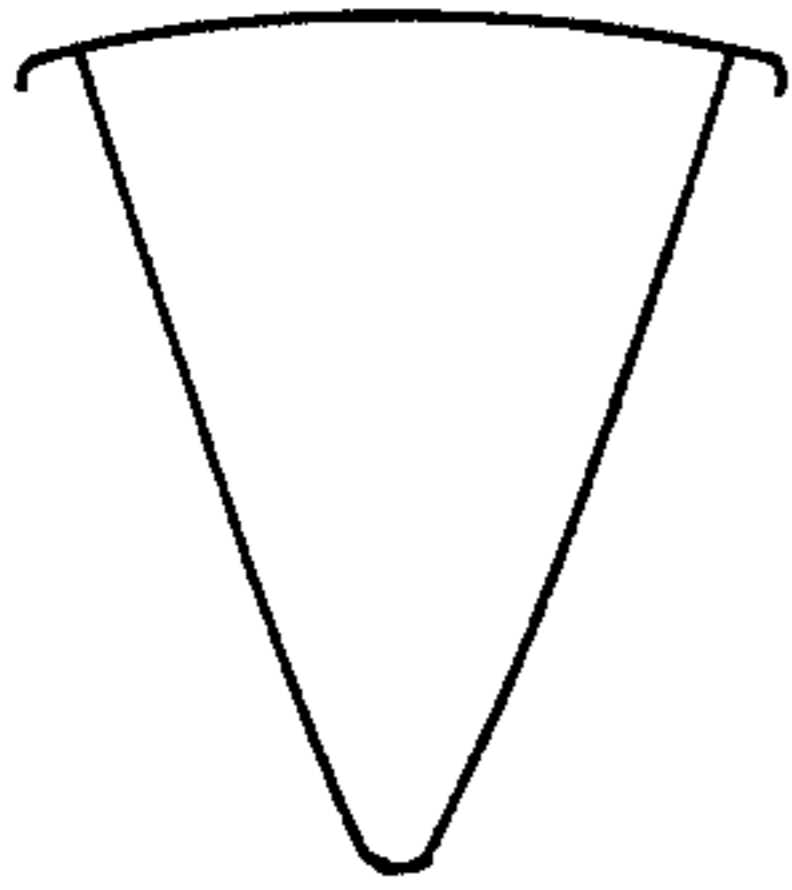

FIG. 9

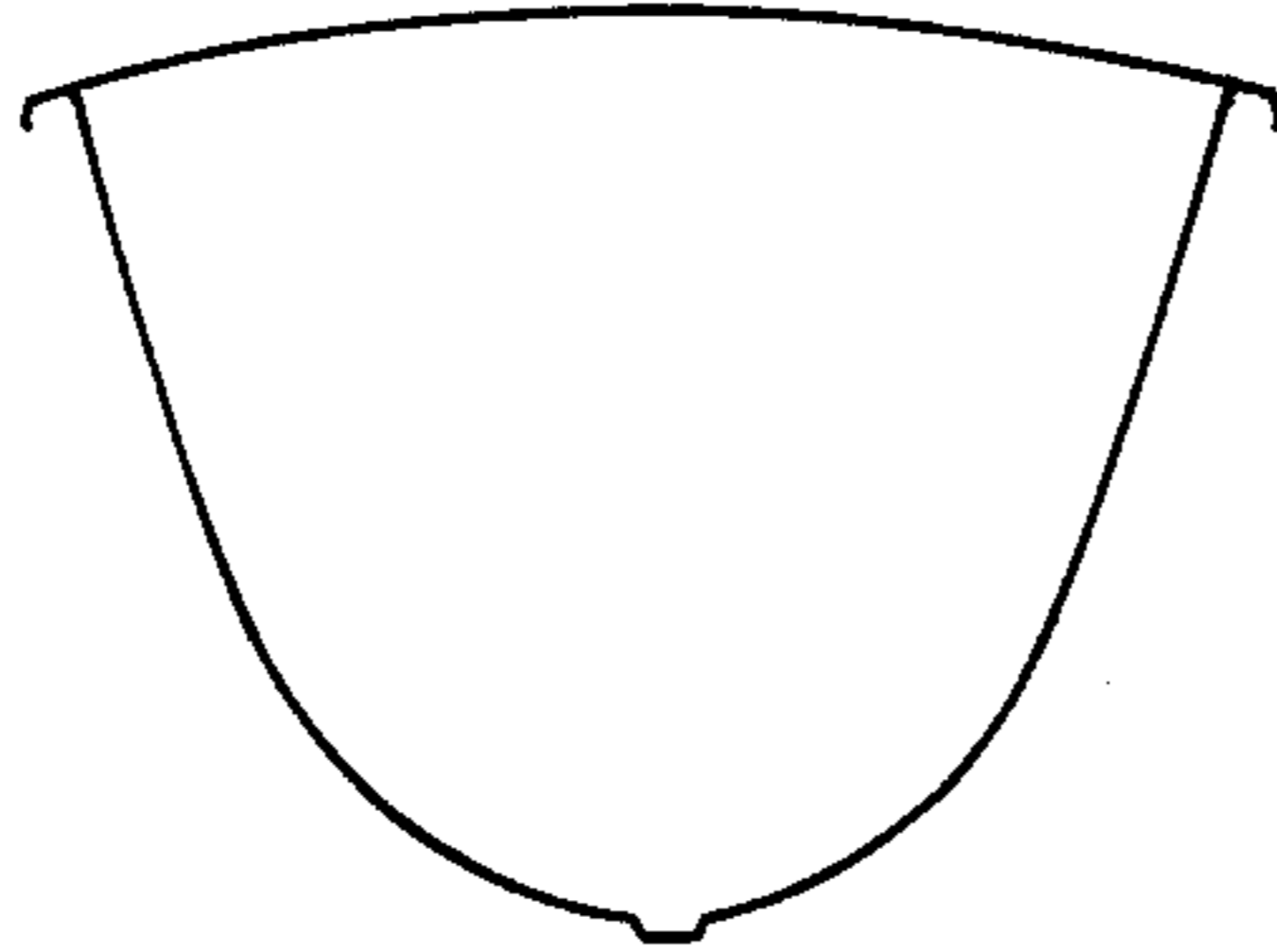

FIG. 10

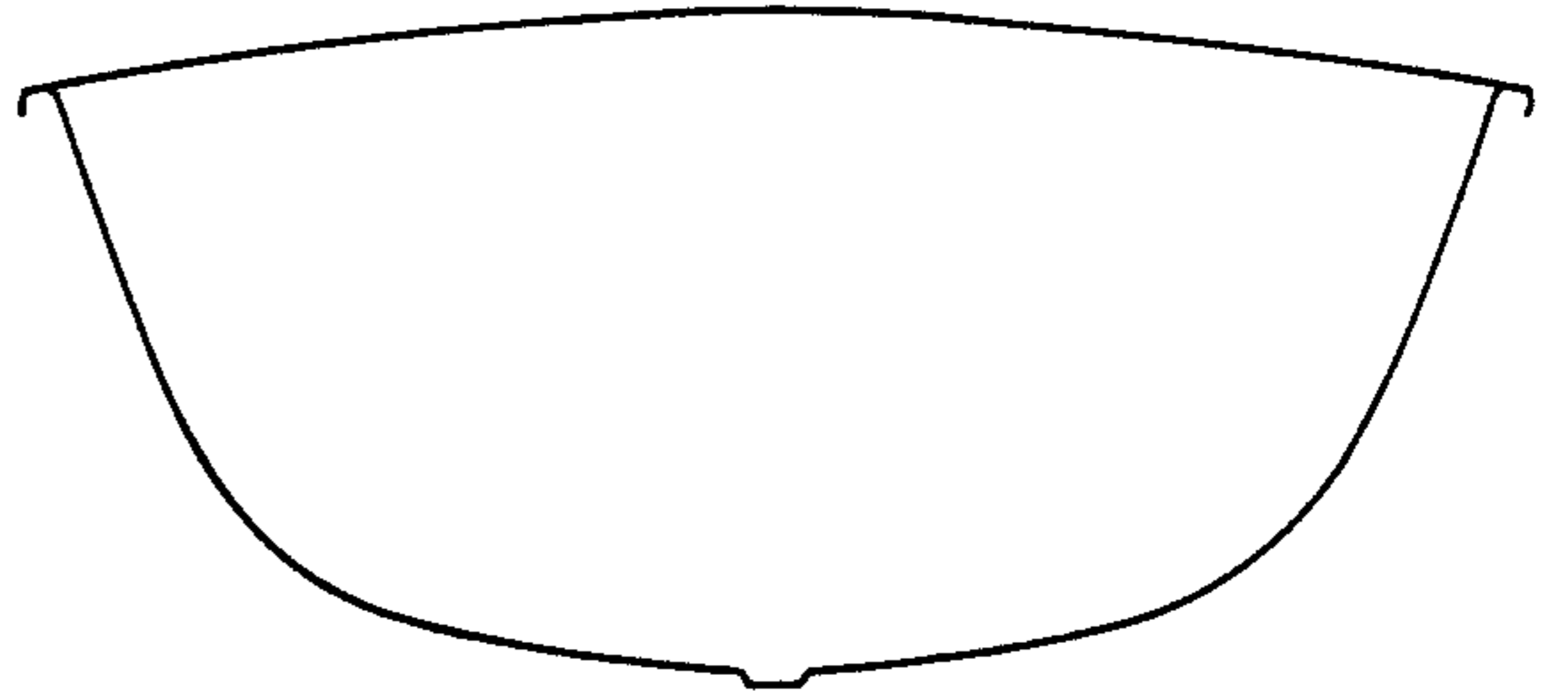

FIG. 11

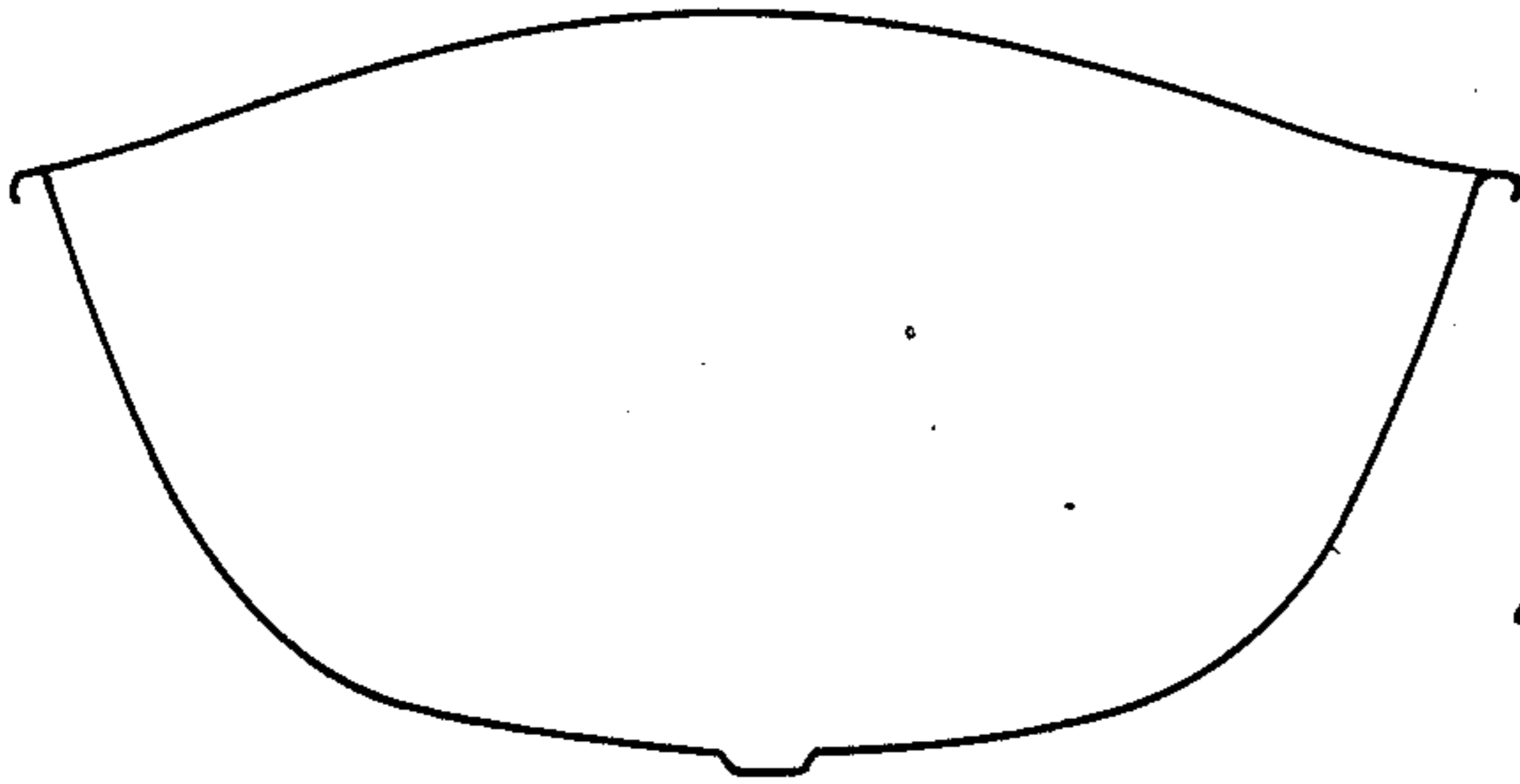

FIG. 12



FIG. 13

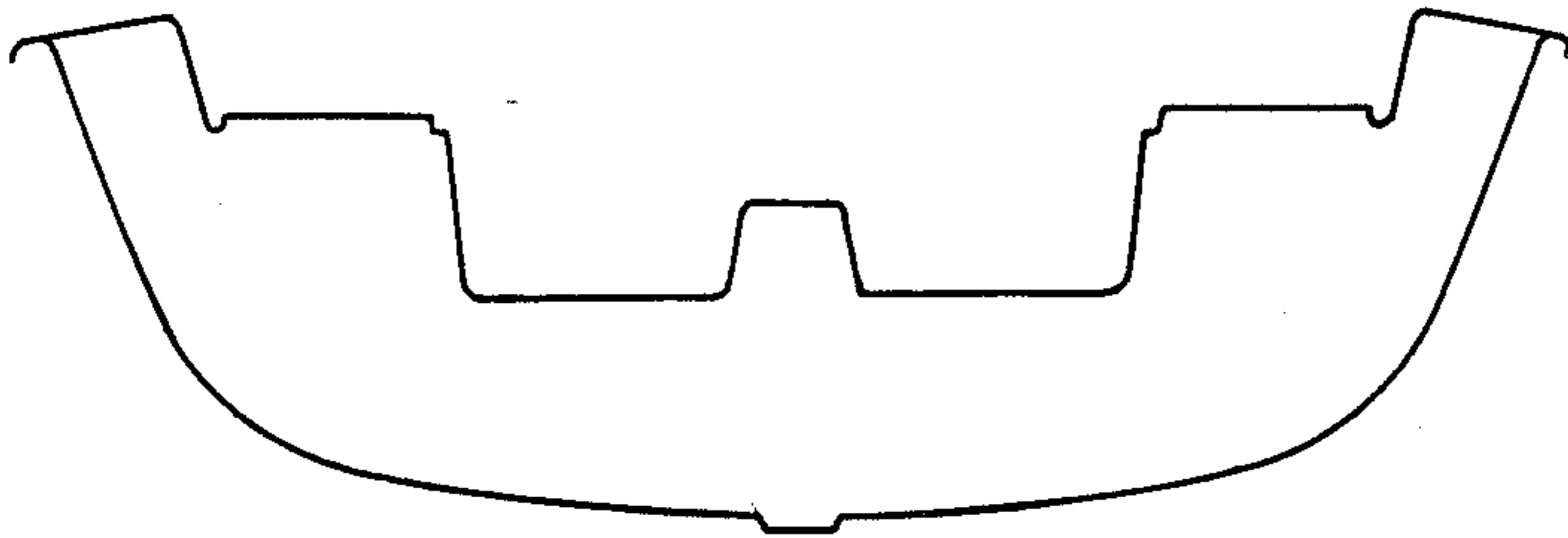

FIG. 14

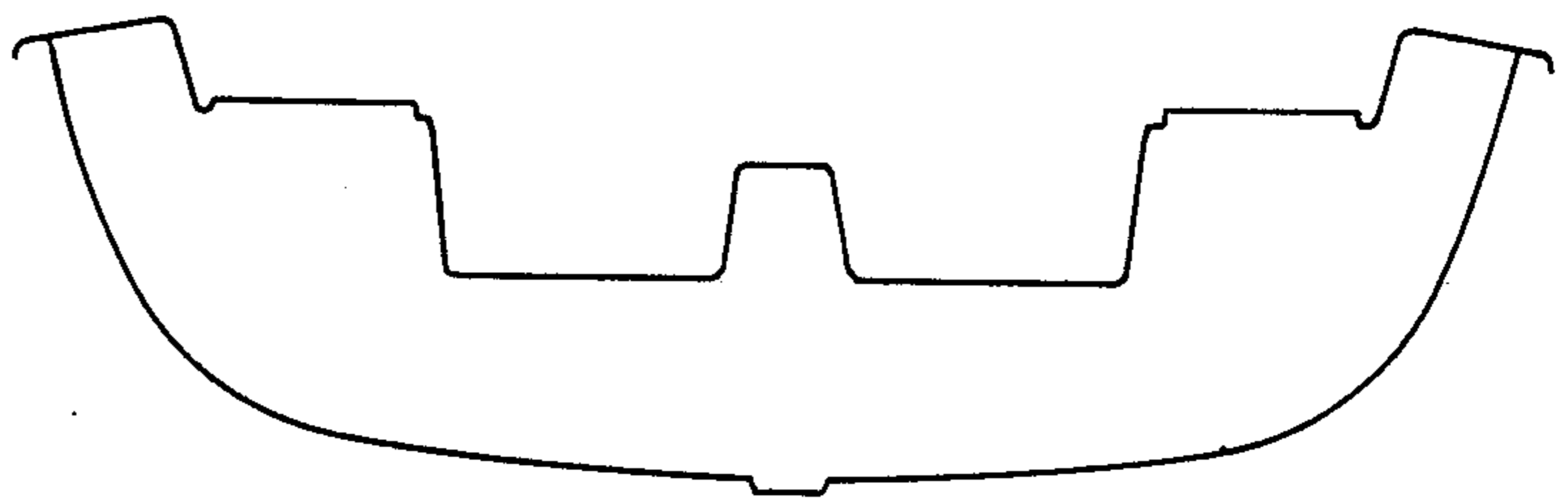
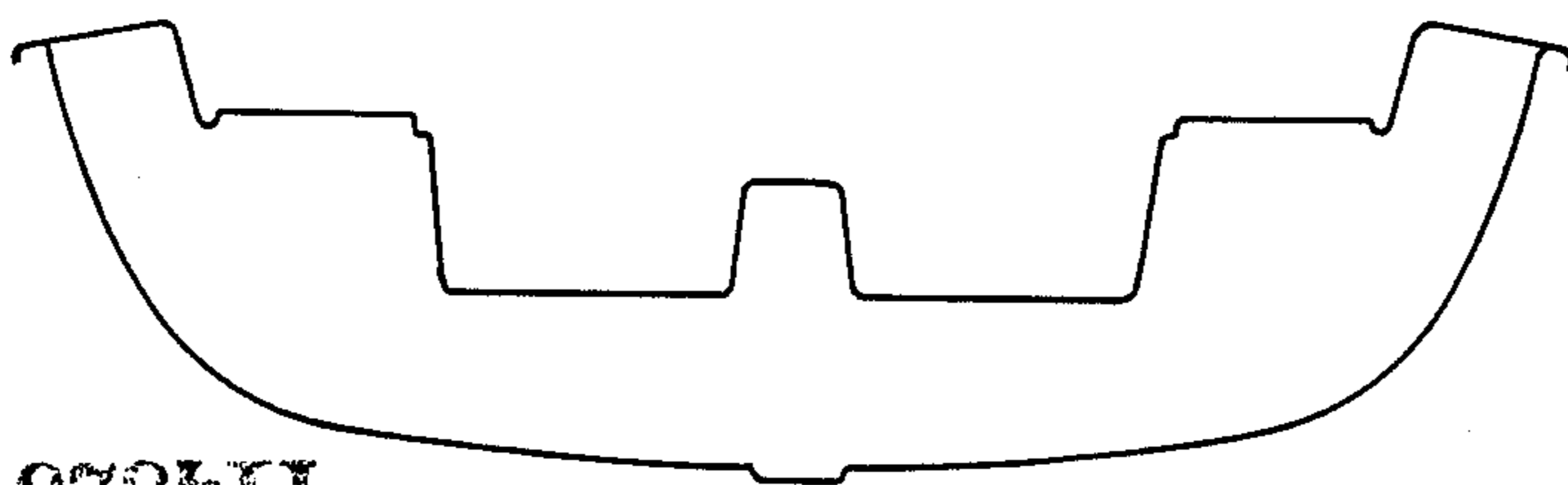

FIG. 15



11/57

FIG. 16

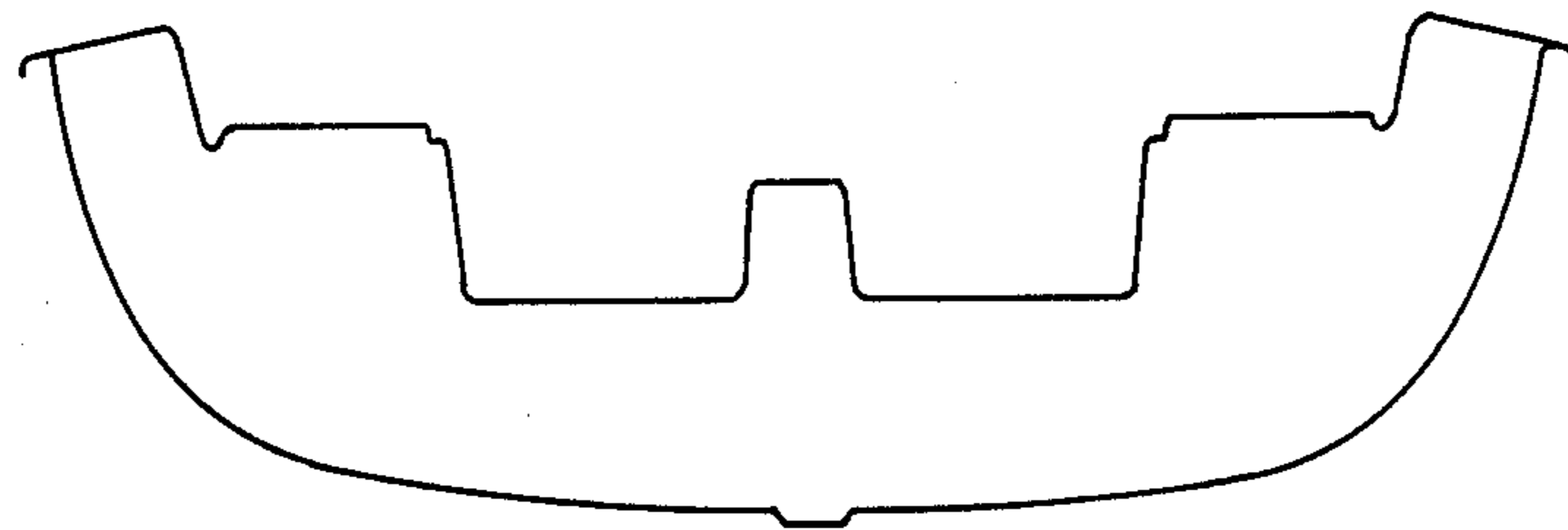

FIG. 17

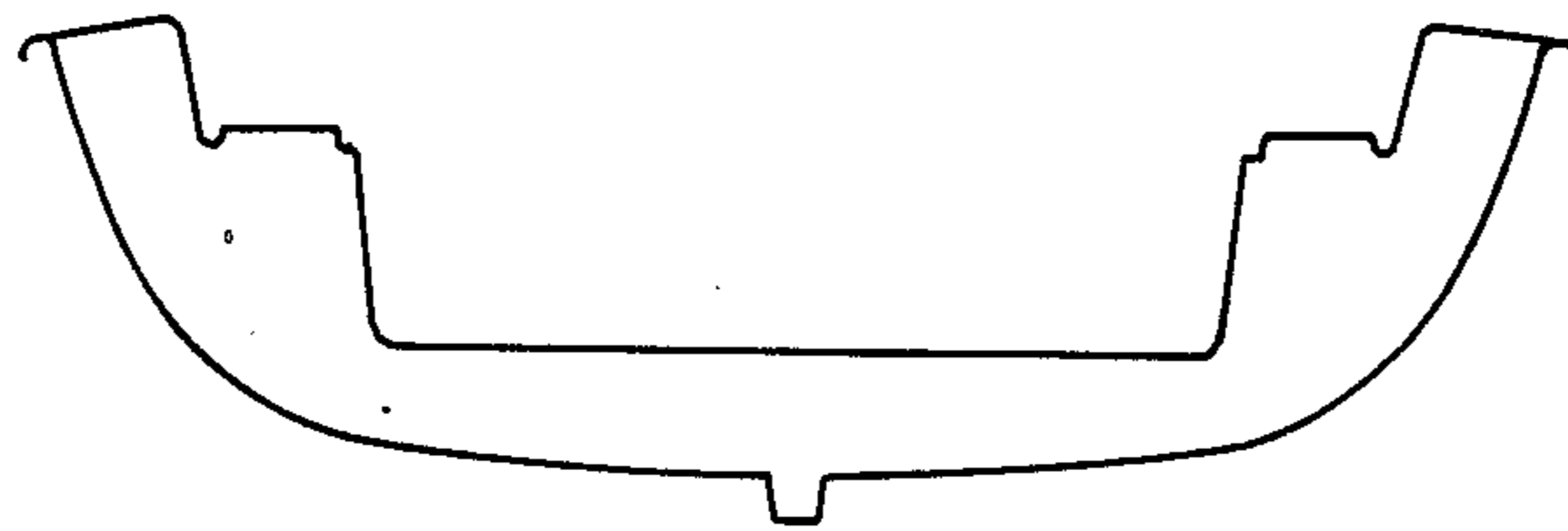

FIG. 18

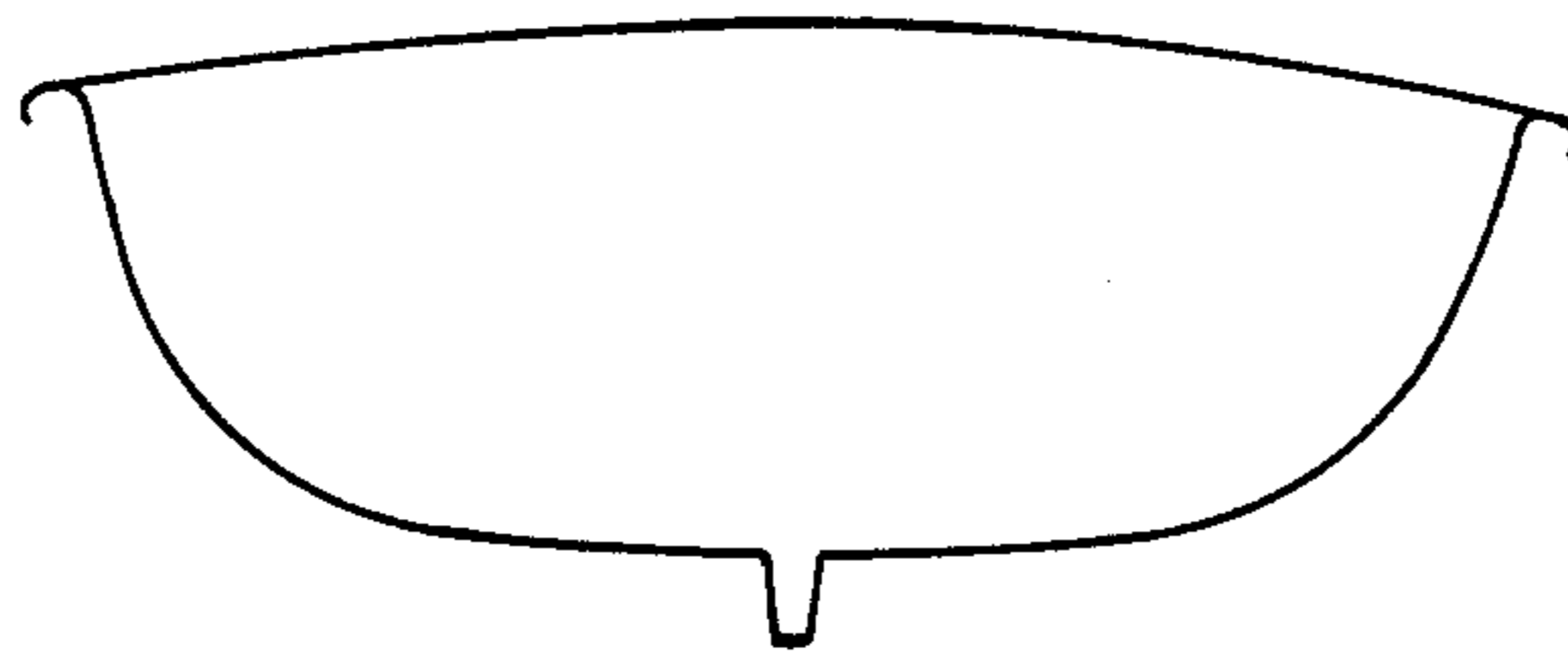

FIG. 19