

[54] **CAN OPENER**  
[75] **Inventor: Gilles Miquelot, Rumilly, France**  
[73] **Assignee: Tefal S.A., Rumilly, France**  
[\*\*] **Term: 14 Years**  
[21] **Appl. No.: 65,571**  
[22] **Filed: Jun. 24, 1987**

[30] **Foreign Application Priority Data**  
Jan. 7, 1987 [FR] France ..... 870057  
[52] **U.S. Cl. .... D8/39**  
[58] **Field of Search .... D8/41, 39-40,**  
**D8/33; 30/400, 409, 426, 427, 404, 424**

[56] **References Cited**  
**U.S. PATENT DOCUMENTS**  
D. 282,521 2/1986 Steinko ..... D8/39

*Primary Examiner—Bernard Ansher*  
*Assistant Examiner—Terry A. Pfeffer*  
*Attorney, Agent, or Firm—Young & Thompson*

[57] **CLAIM**

The ornamental design for a can opener, as shown and described.

**DESCRIPTION**

FIG. 1 is a top plan view of a can opener showing my new design;  
FIG. 2 is a bottom plan view thereof;  
FIG. 3 is a right side elevational view thereof;  
FIG. 4 is a left side elevational view thereof;  
FIG. 5 is a front elevational view thereof;  
FIG. 6 is a rear elevational view thereof;  
FIG. 7 is a top perspective view thereof; and  
FIG. 8 is a bottom perspective view thereof in an open position.

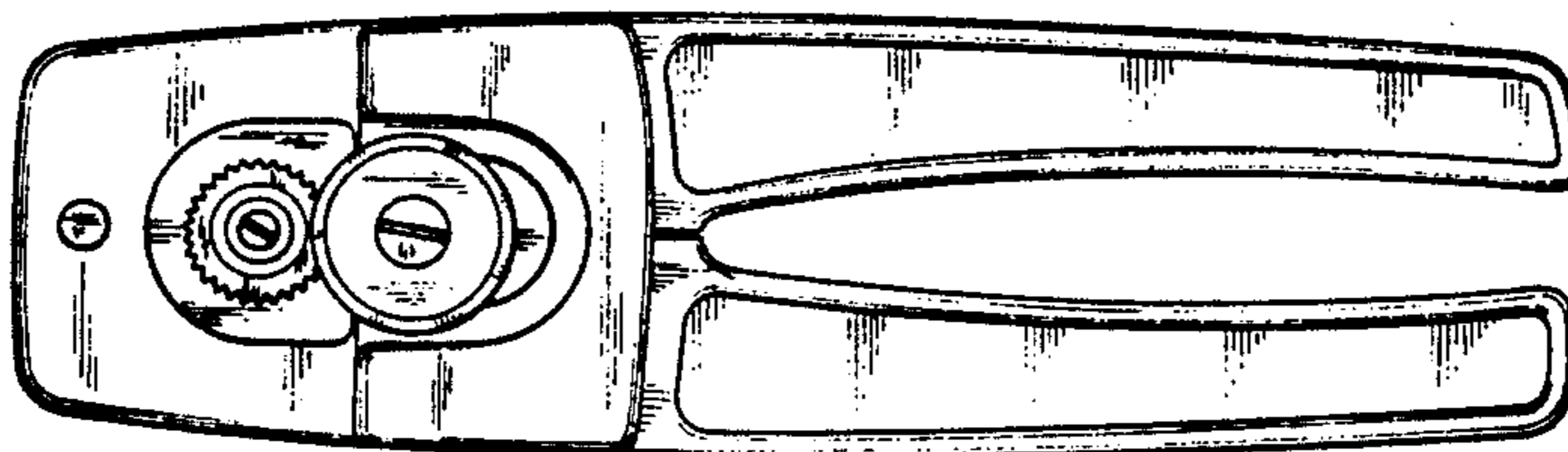
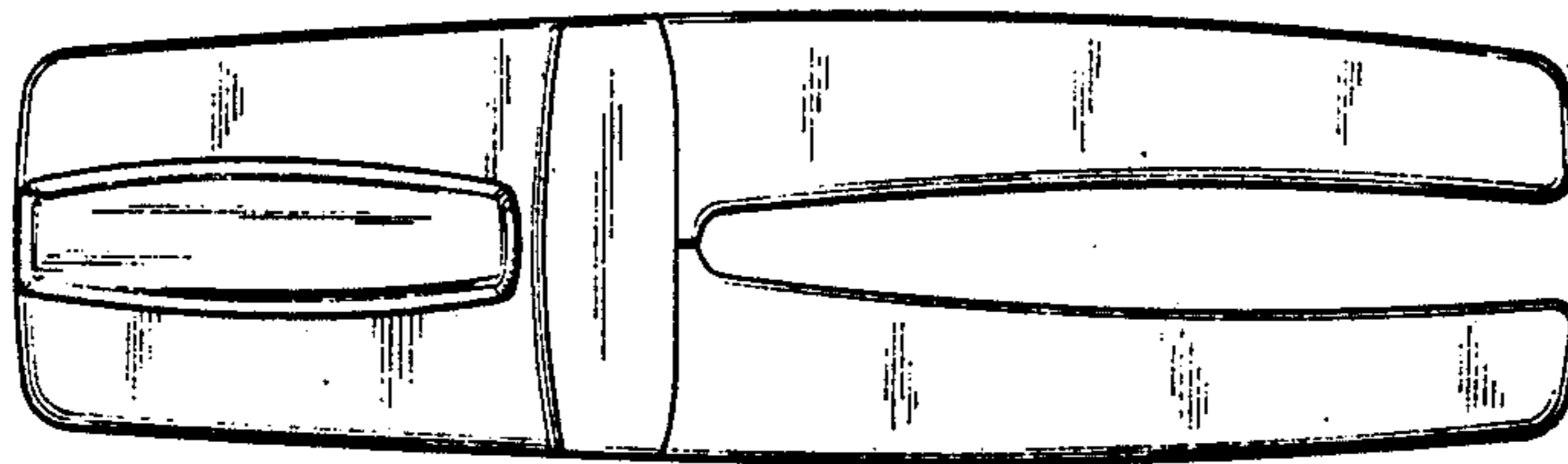

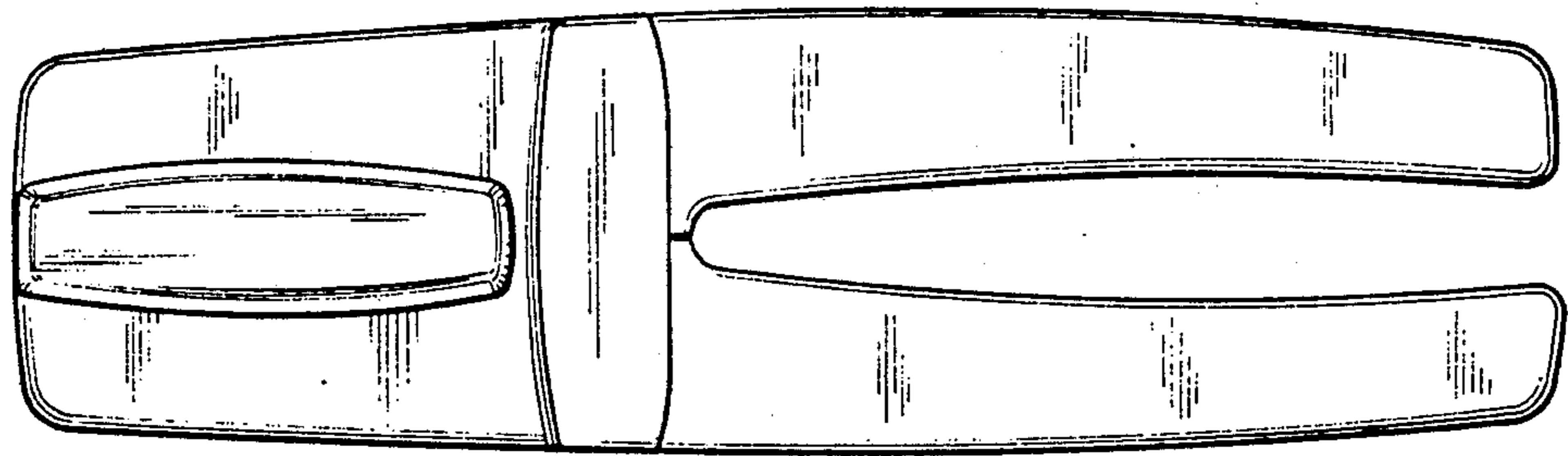

FIG. 1

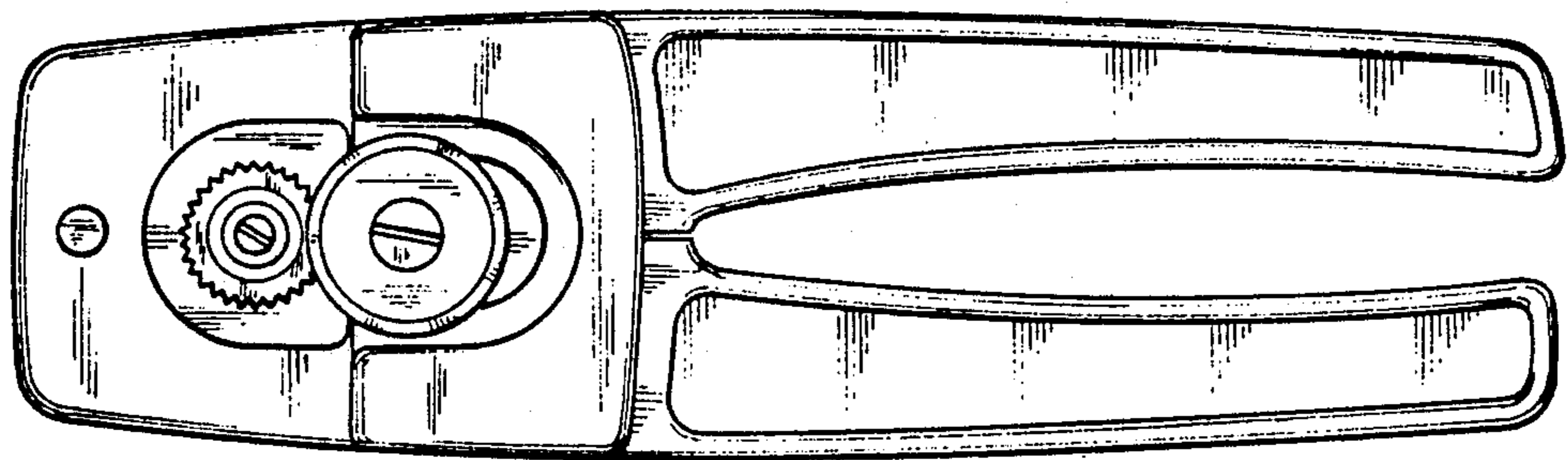

FIG. 2

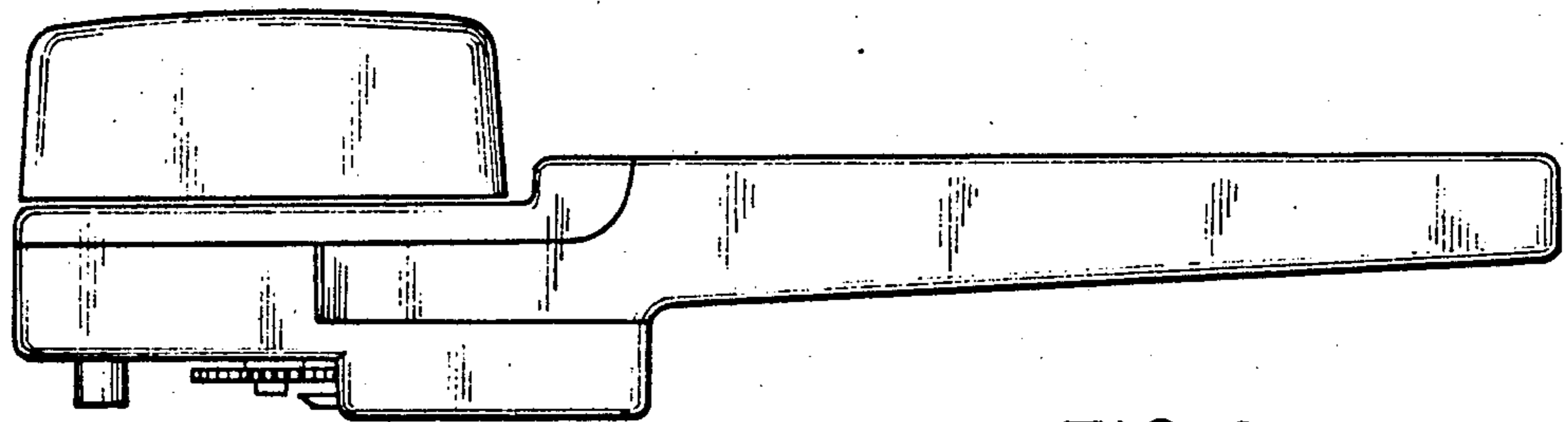

FIG. 3

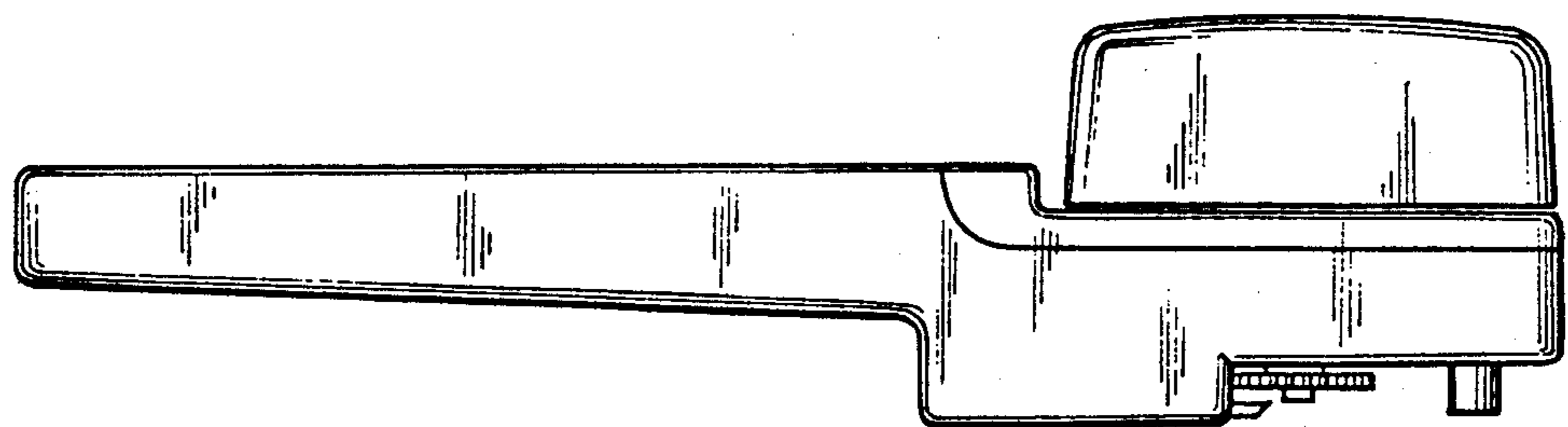

FIG. 4

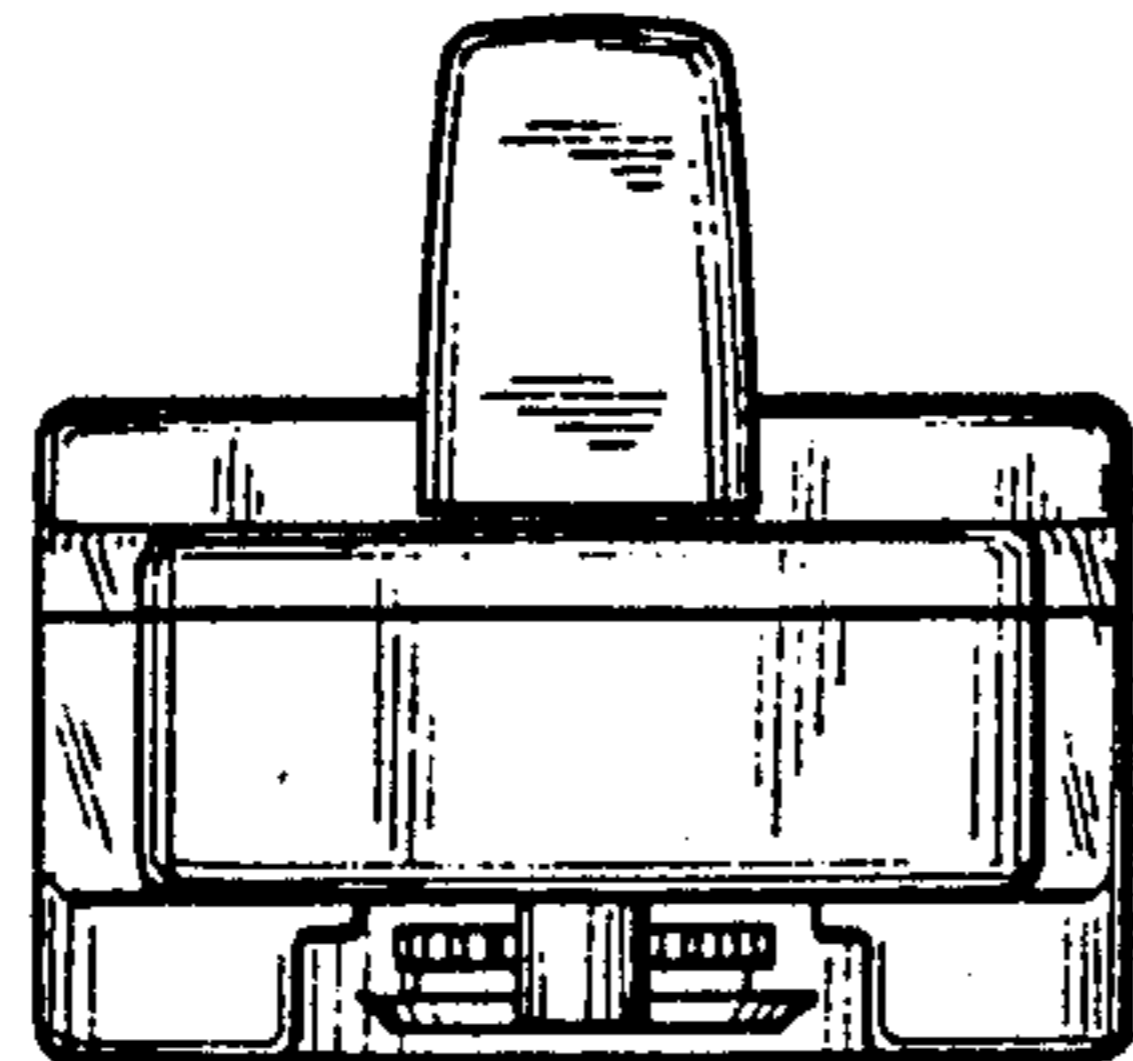

FIG. 5

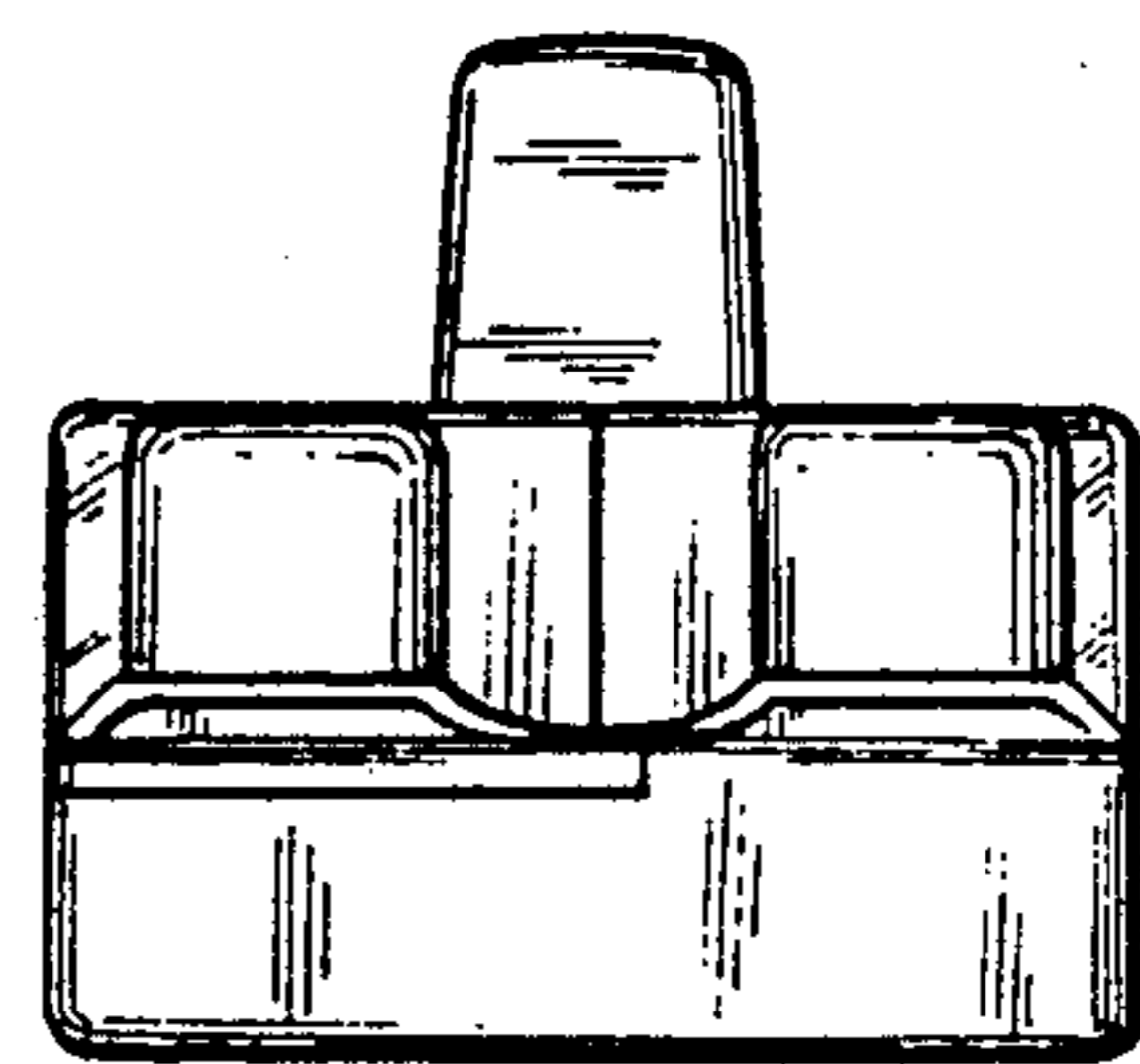

FIG. 6

FIG. 7

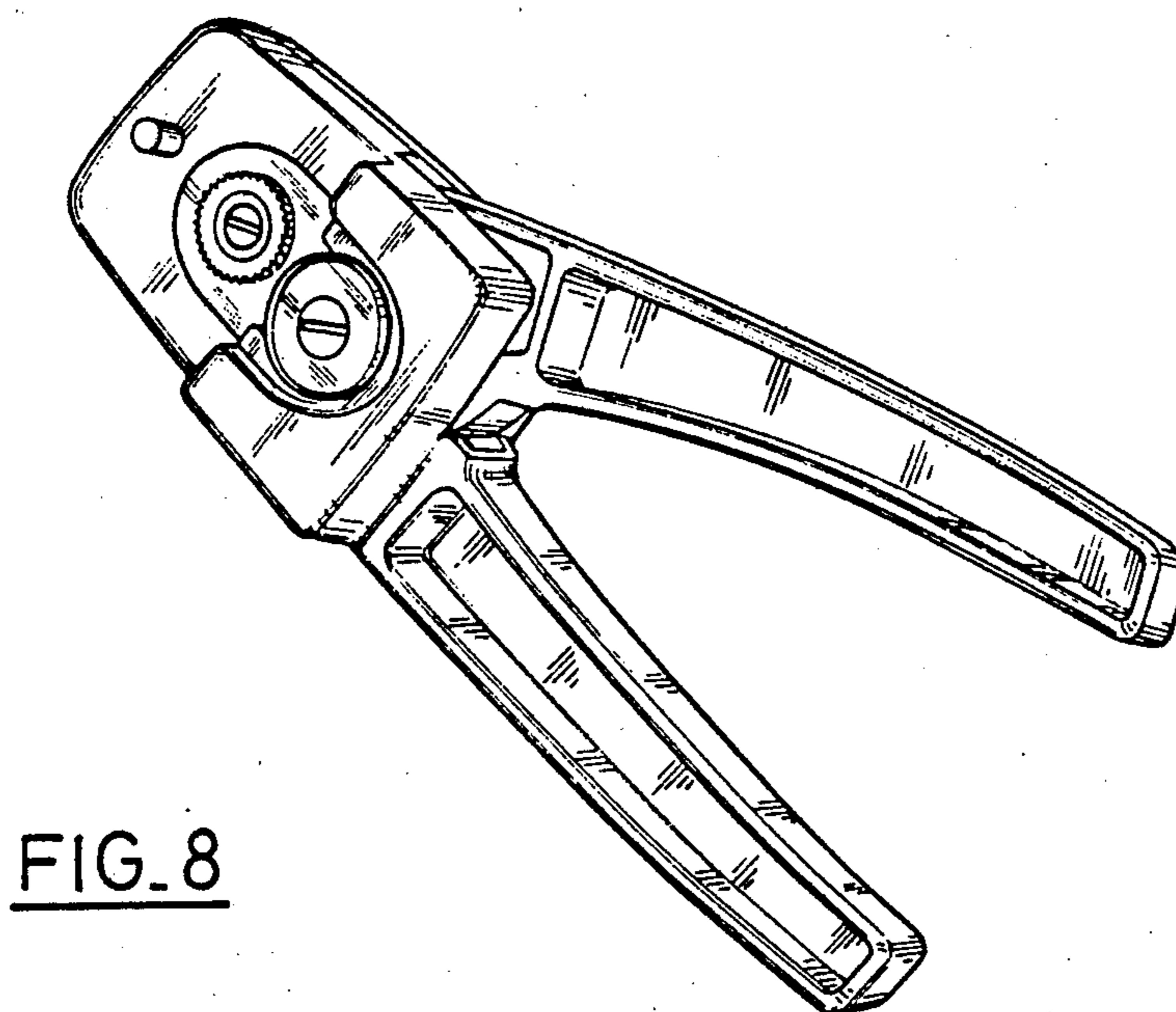
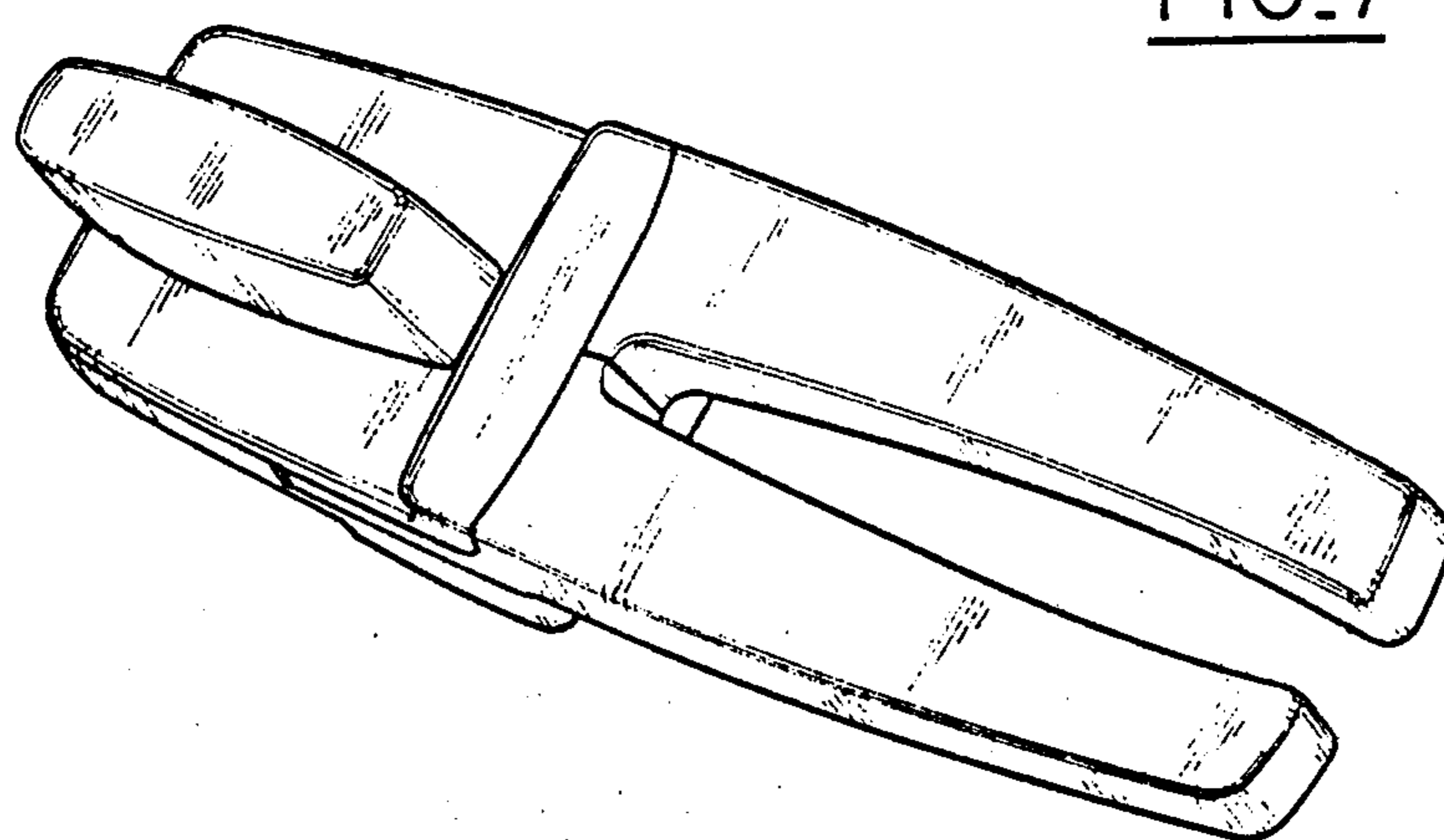

FIG. 8