

[54] 35 MM CAMERA

[75] Inventor: Susumu Koshino, Tokyo, Japan

[73] Assignee: Asahi Kogaku Kogyo Kabushiki Kaisha, Tokyo, Japan

[**] Term: 14 Years

[21] Appl. No.: 1,492

[22] Filed: Jan. 8, 1987

[30] Foreign Application Priority Data

Sep. 1, 1986 [JP] Japan 61-34504
[52] U.S. Cl. D16/209
[58] Field of Search D16/200, 208, 209, 217,
D16/218; 354/126, 127.11, 149.1, 149.11, 202,
288

[56] References Cited

U.S. PATENT DOCUMENTS

D. 284,197 6/1986 Yamamoto et al. D16/209
D. 285,450 9/1986 Soda D16/209
D. 289,175 4/1987 Noda D16/209

D. 293,917 1/1988 Tanaka et al. D16/209
D. 296,703 7/1988 Goto et al. D16/209

OTHER PUBLICATIONS

Evans Catalog 1984-1985, p. 343, (Item 3 top-center, Nikon L35AF).

Primary Examiner—Bernard Ansher
Assistant Examiner—Adir Aronovich
Attorney, Agent, or Firm—Sughrue, Mion, Zinn,
Macpeak & Seas

[57] CLAIM

The ornamental design for a 35 mm camera, as shown.

DESCRIPTION

FIG. 1 is a front, top and right side perspective view of a 35 mm camera showing my new design; FIG. 2 is a front elevational view thereof; FIG. 3 is a rear elevational view thereof; FIG. 4 is a left side elevational view thereof; FIG. 5 is a right side elevational view thereof; FIG. 6 is a top plan view thereof; and FIG. 7 is a bottom plan view thereof.

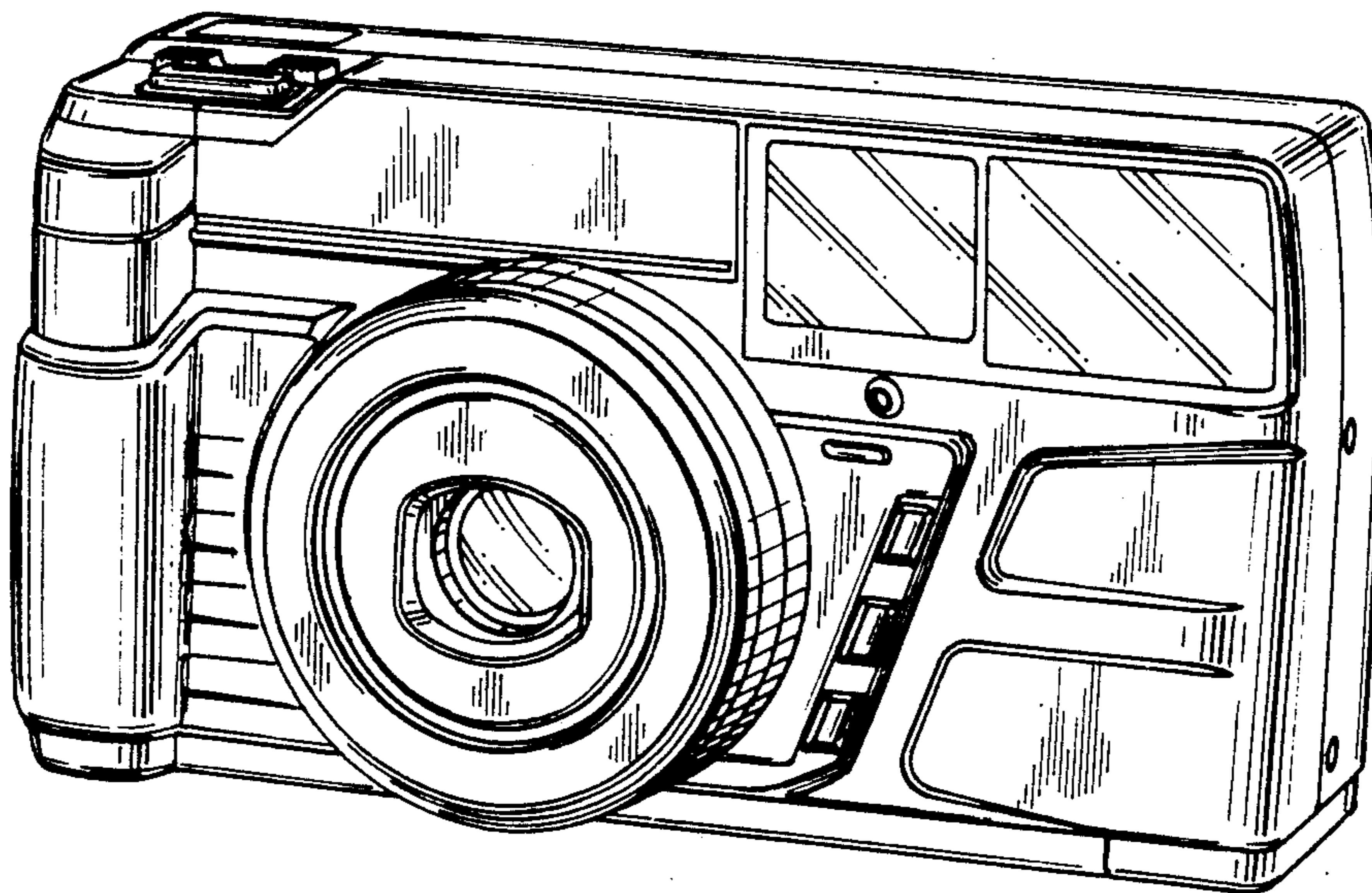

FIG. 1

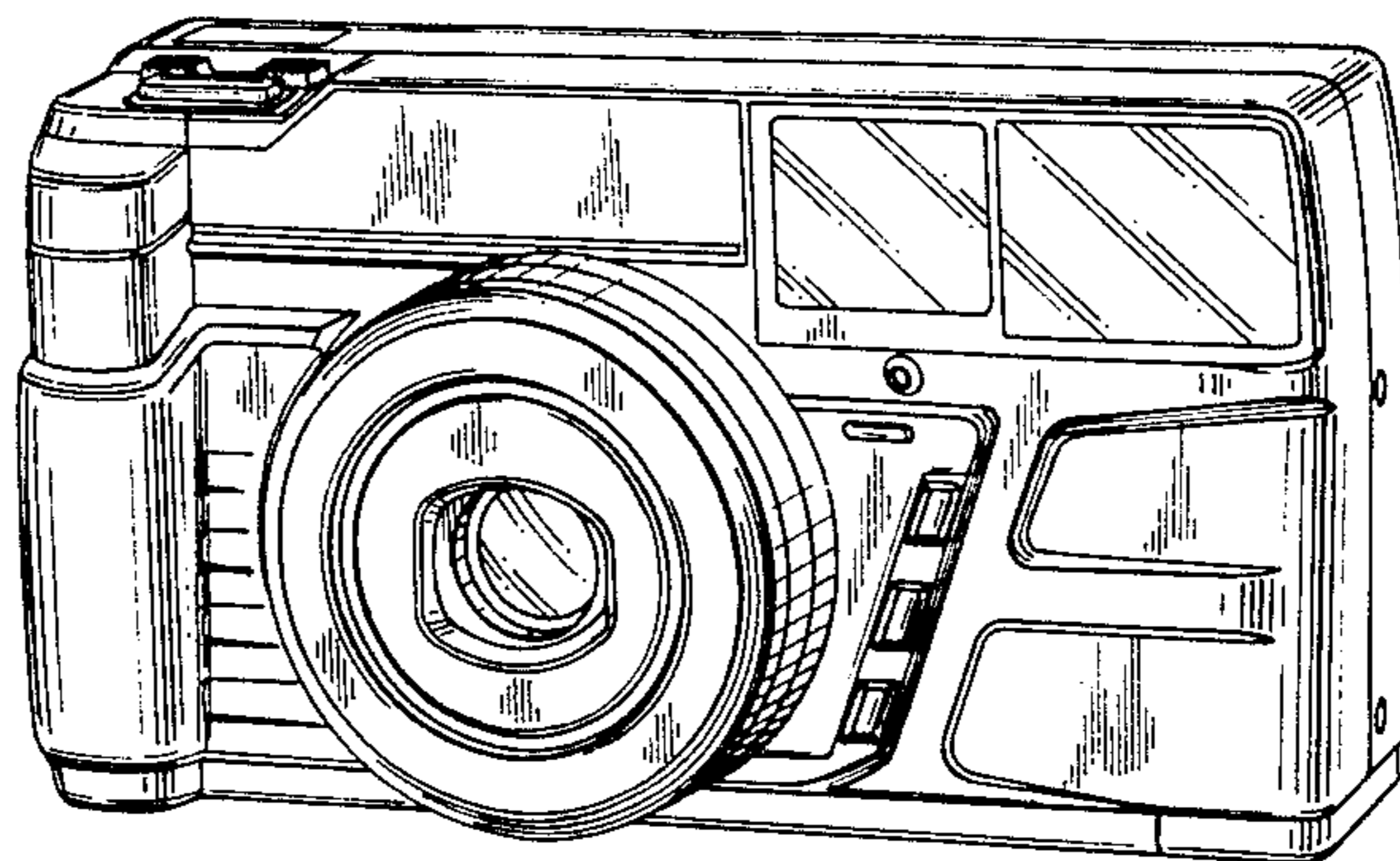

FIG. 2

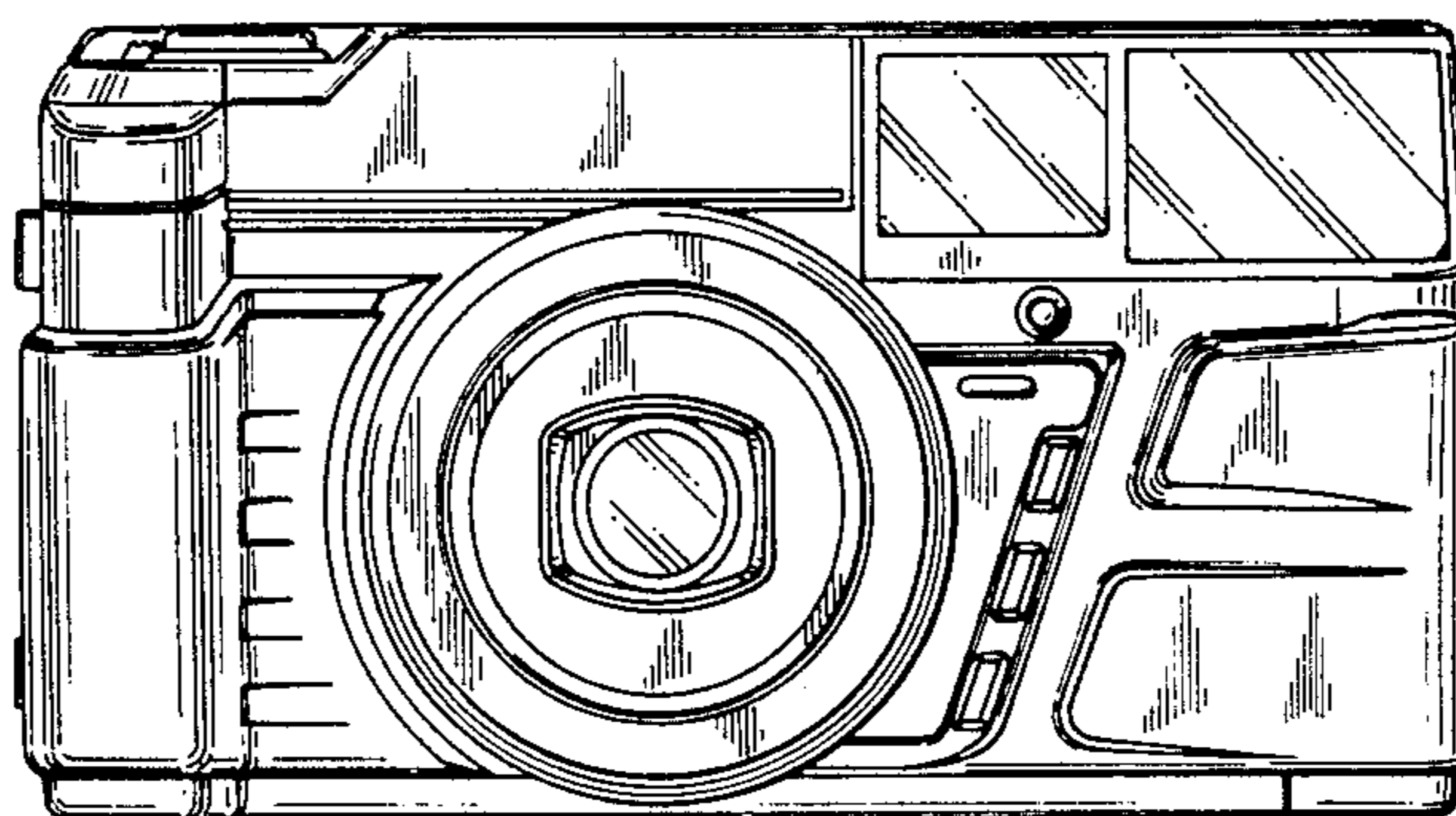

FIG. 3

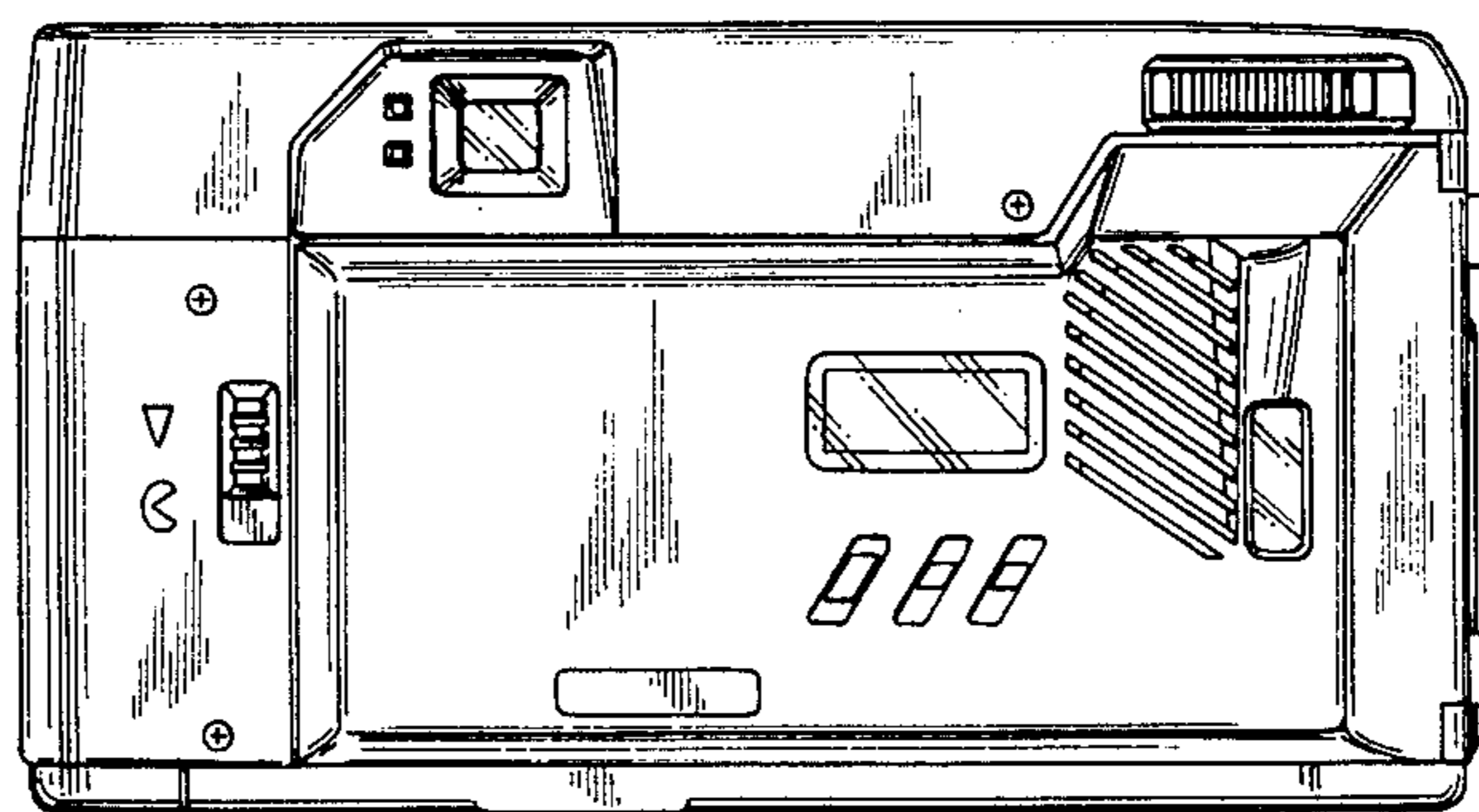

FIG. 4

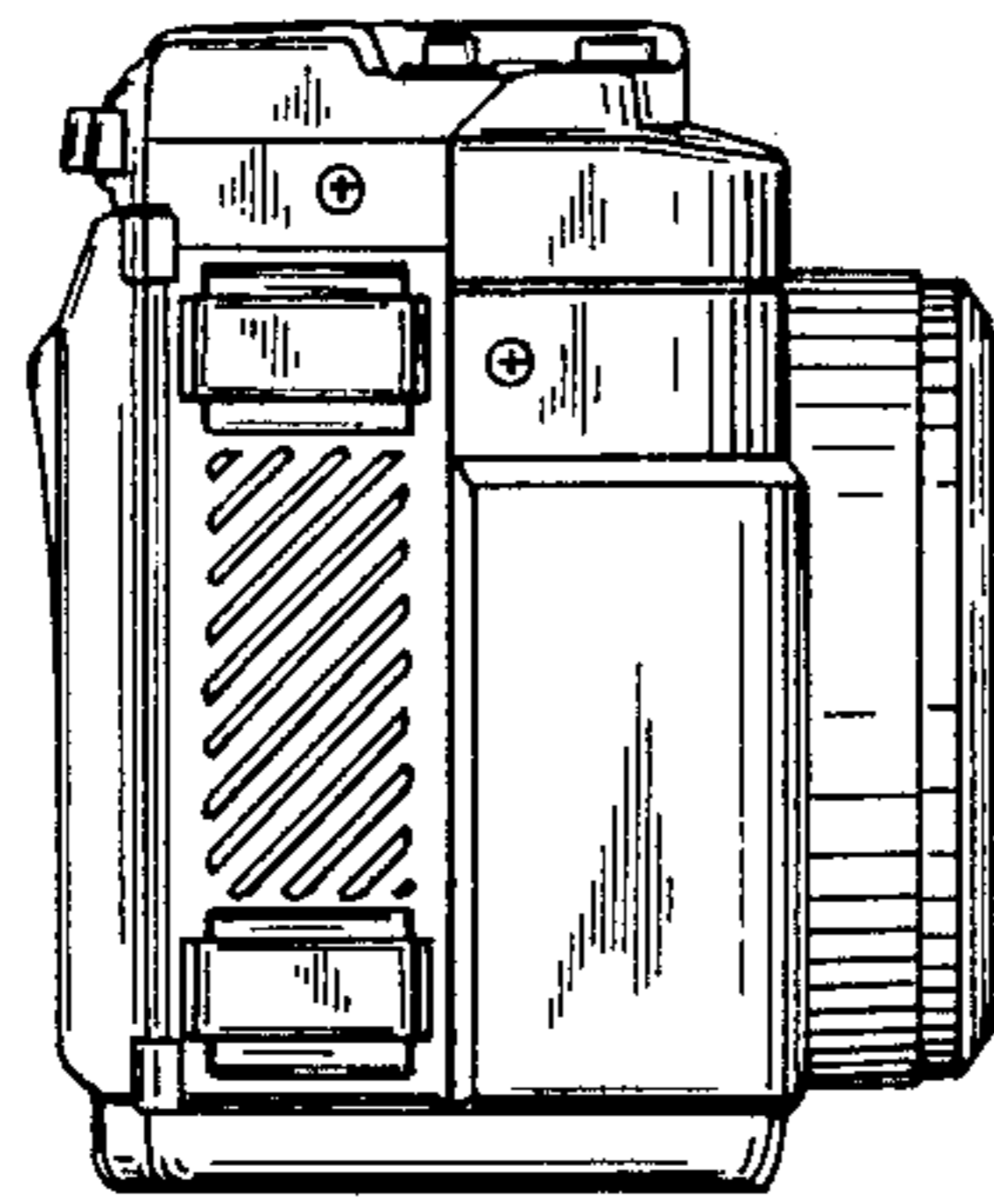

FIG. 5

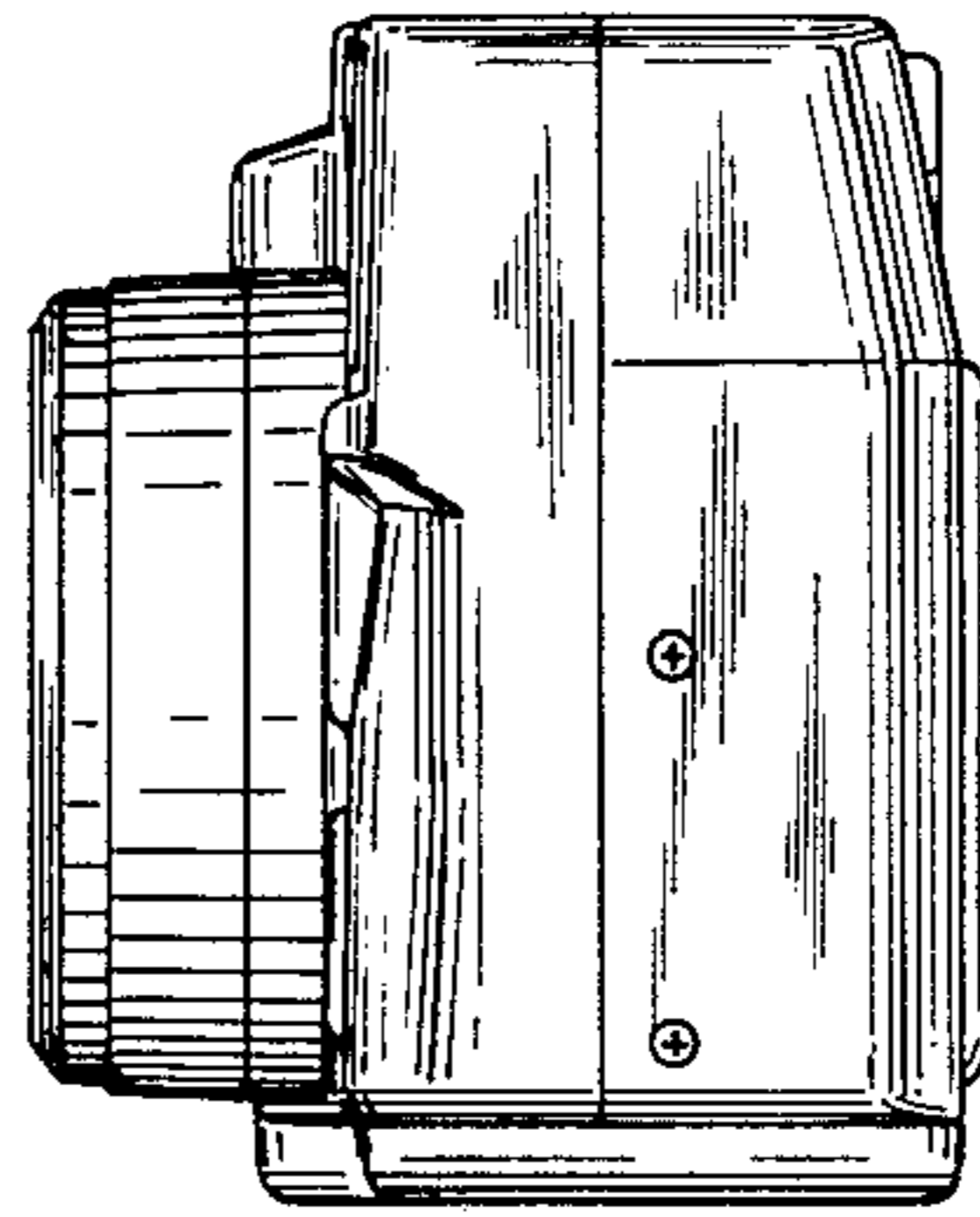

FIG. 6

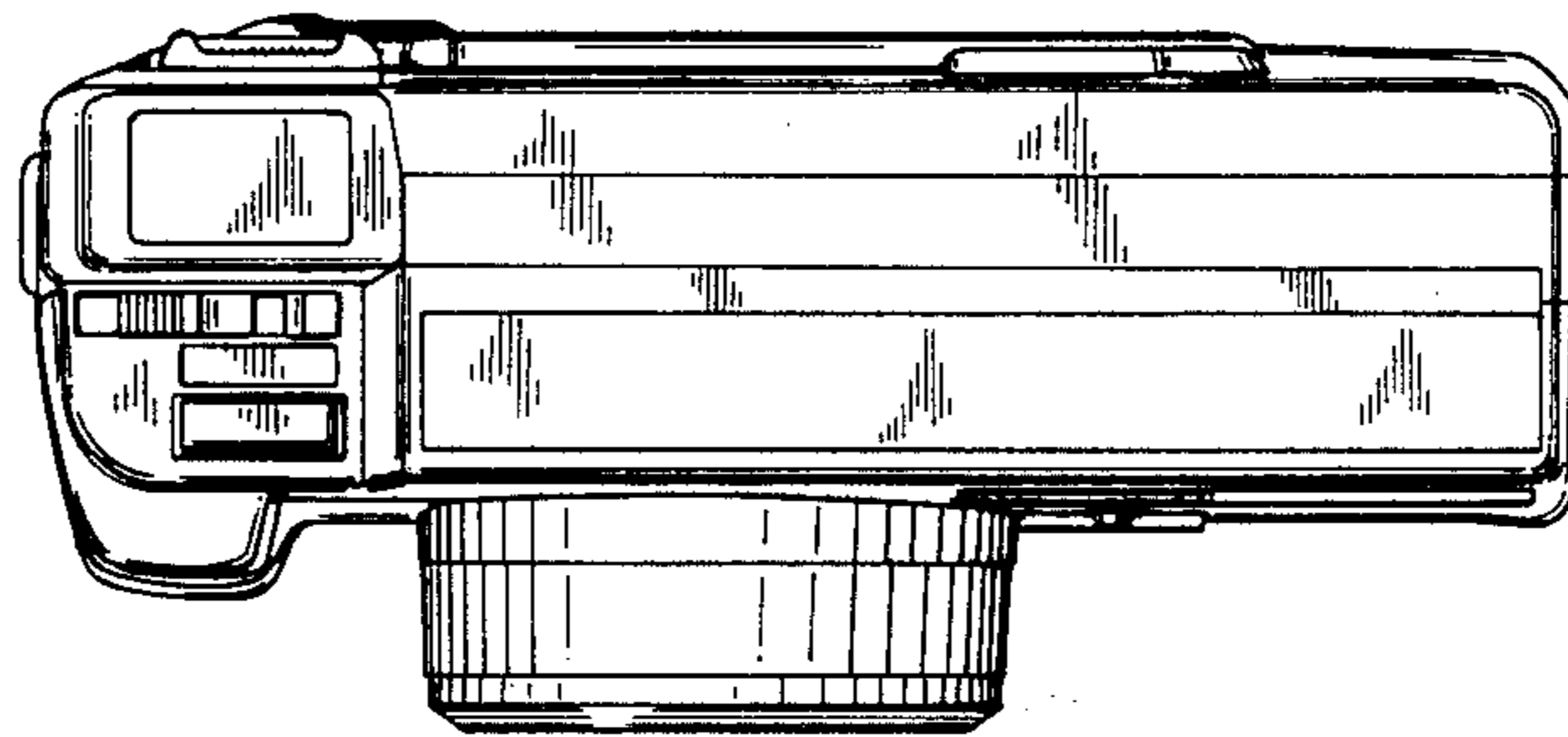

FIG. 7

