

[54] TELEPHONE SET

[76] Inventor: Ping Kwan Ng, Flat 1506, 15th Floor, Block N, Kornhill, No. 14, Hong On Street, Quarry Bay, Hong Kong

[**] Term: 14 Years

[21] Appl. No.: 145,778

[22] Filed: Jan. 19, 1988

[30] Foreign Application Priority Data

Oct. 14, 1987 [GB] United Kingdom 1045613

[52] U.S. Cl. D14/140; D14/149; D14/248; D14/151

[58] Field of Search D14/53, 62, 64, 63; 379/433, 419, 440, 436, 435

[56] References Cited

U.S. PATENT DOCUMENTS

- D. 283,708 5/1986 Tamura D14/62 X
- D. 284,657 7/1986 Marshall D14/63 X
- D. 285,921 9/1986 Beese D14/63 X
- D. 286,283 10/1986 Nichols D14/60 X
- D. 291,565 8/1987 Okuda D14/53
- D. 297,138 8/1988 Culver et al. D14/53 X

- D. 298,239 10/1988 Hirose et al. D14/53 X
- D. 298,320 11/1988 Hirose et al. D14/53
- D. 298,619 11/1988 Kuo D14/57 X
- D. 298,937 12/1988 Dunsoll et al. D14/58
- D. 299,132 12/1988 Asaki et al. D14/62 X

Primary Examiner—Horace B. Fay, Jr.
Attorney, Agent, or Firm—Darby & Darby

[57] CLAIM

The ornamental design for telephone set, as shown and described.

DESCRIPTION

FIG. 1 is a front elevational view of a telephone set showing my new design;
 FIG. 2 is a rear elevational view thereof;
 FIGS. 3 and 4 are respectively right and left side elevational views thereof;
 FIGS. 5 and 6 are respectively top and bottom plan views thereof;
 FIG. 7 is a front perspective view of the set is assembled position with the handset cradled upon its stand; and
 FIG. 8 is a similar front perspective view thereof with the handset inverted and spaced apart from the stand for clarity of representation of the handset and stand.

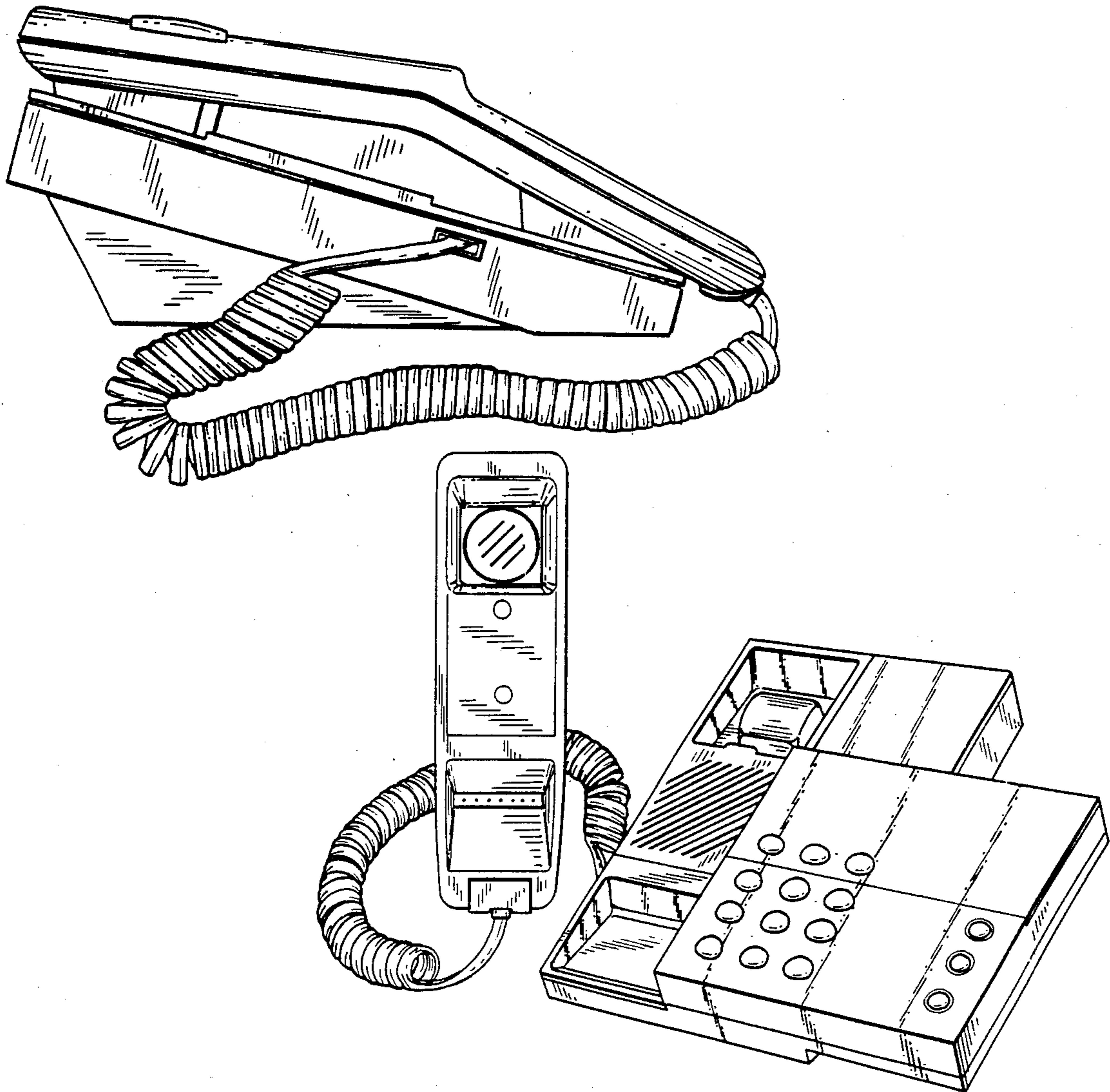

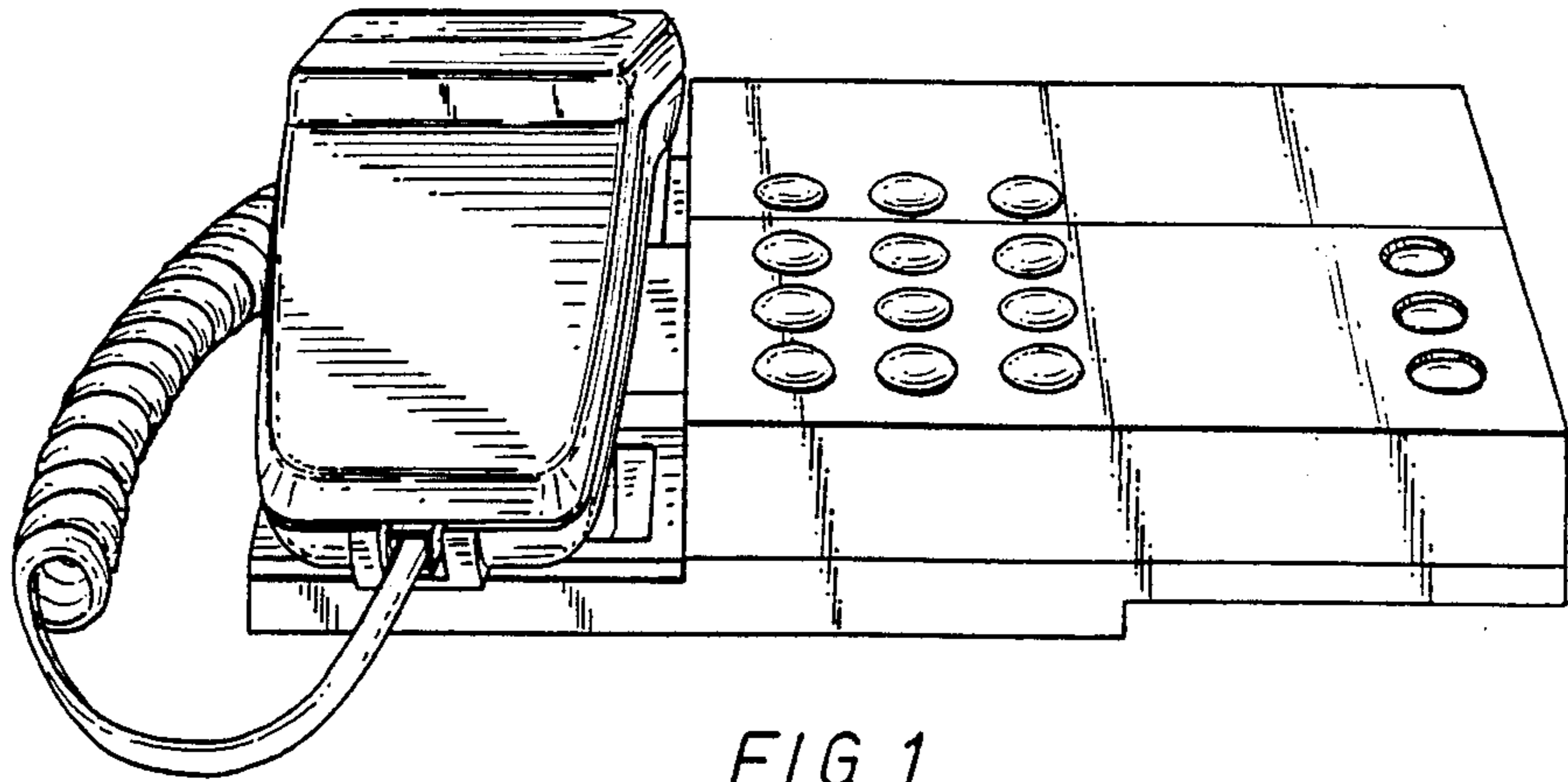

FIG. 1.

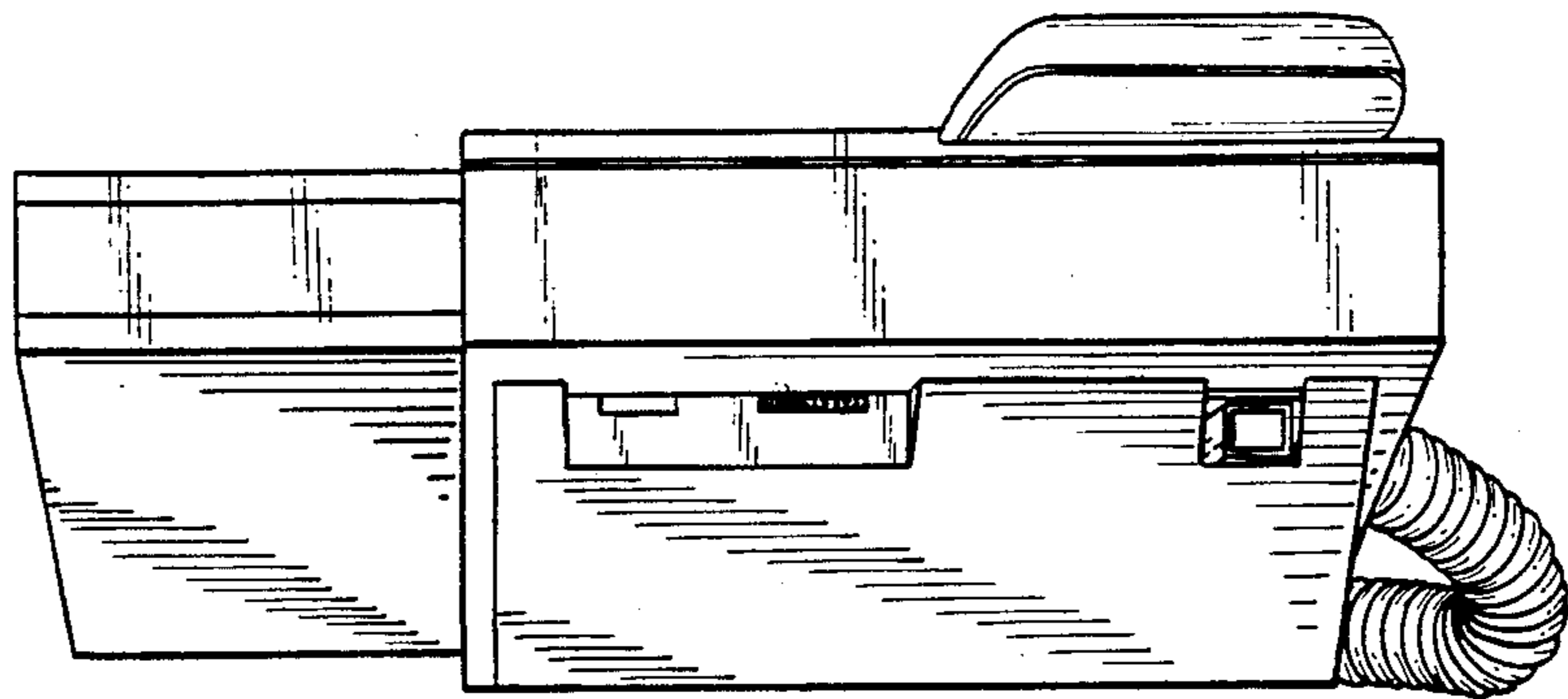

FIG. 2.

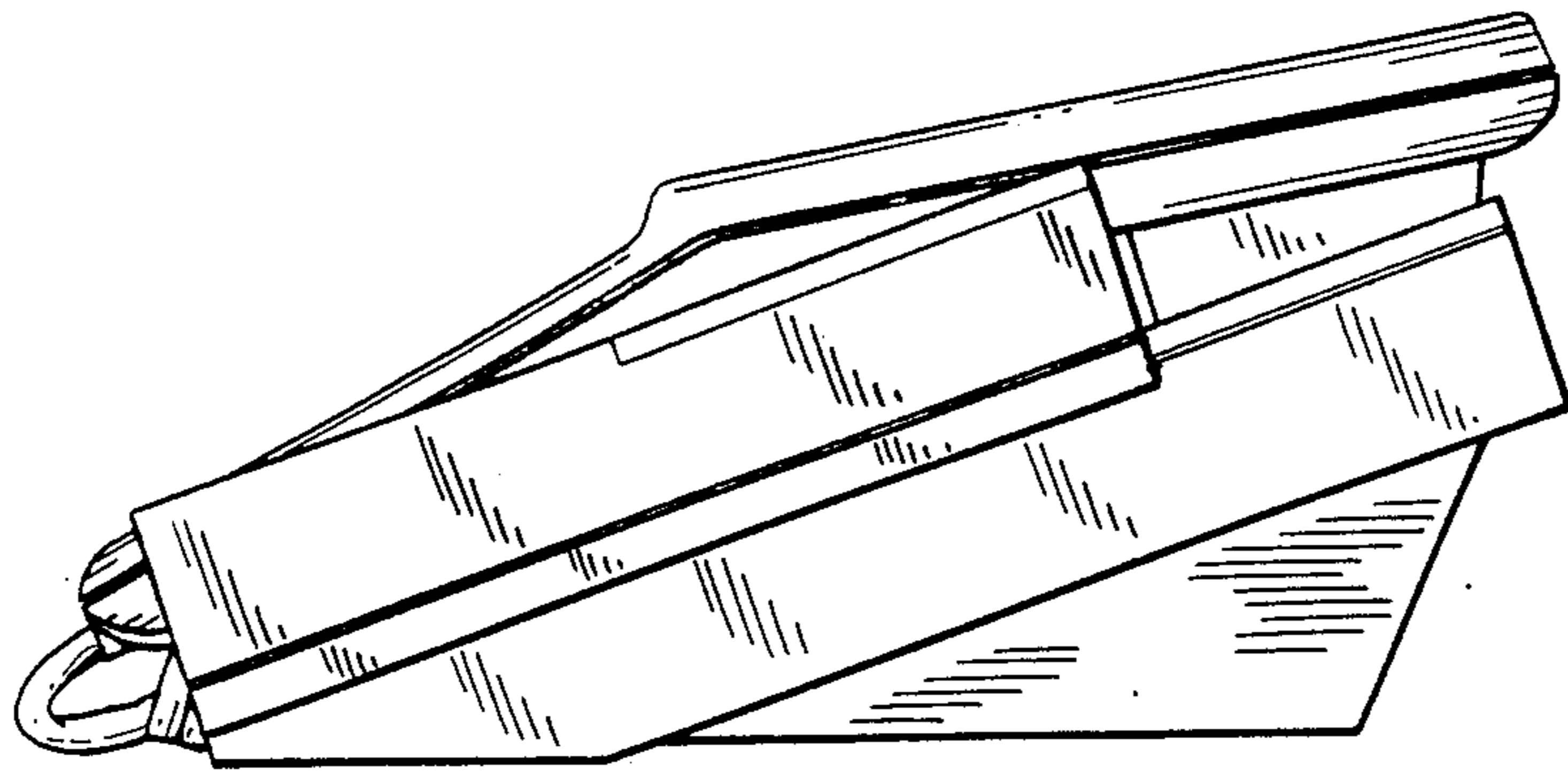

FIG. 3.

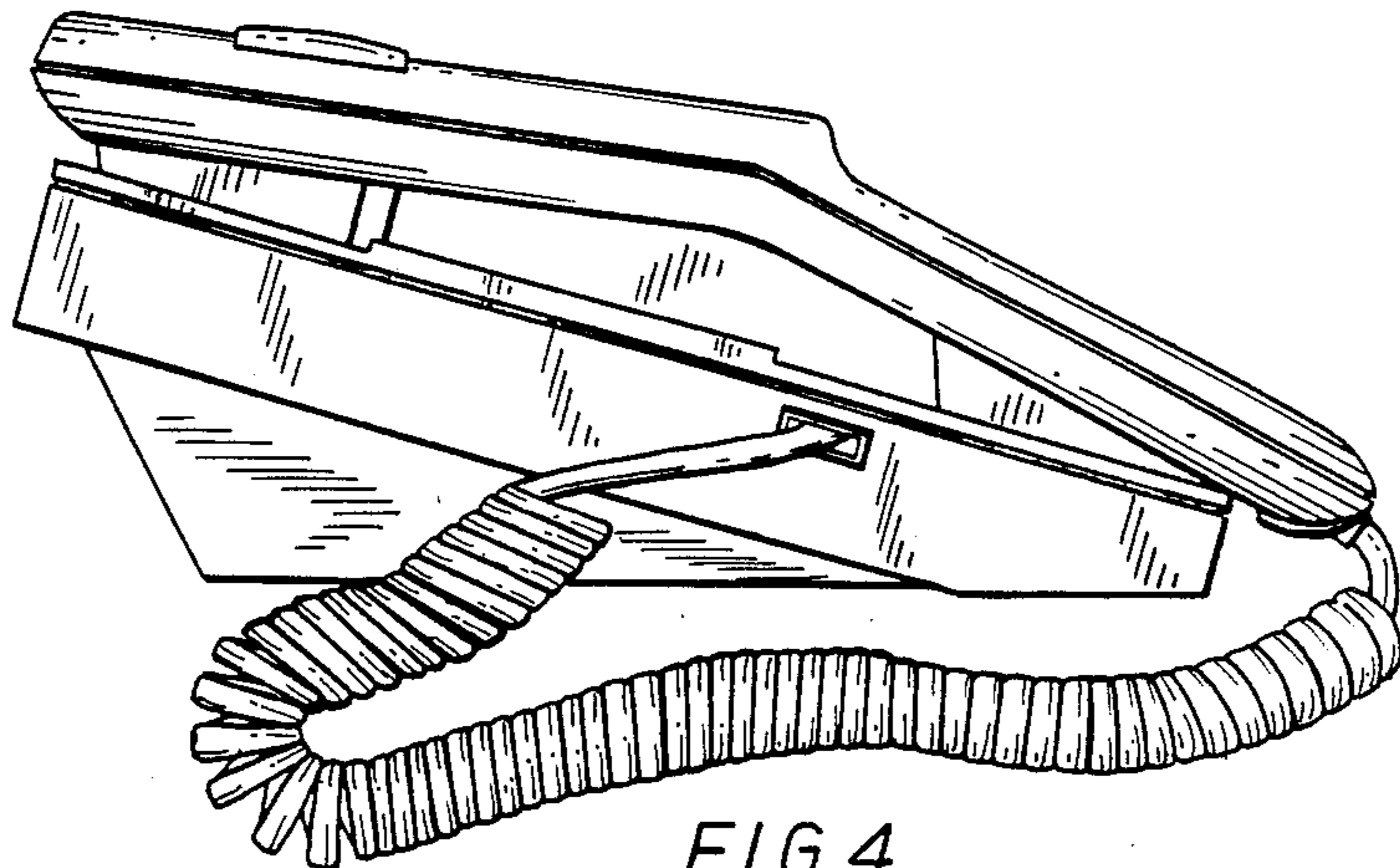
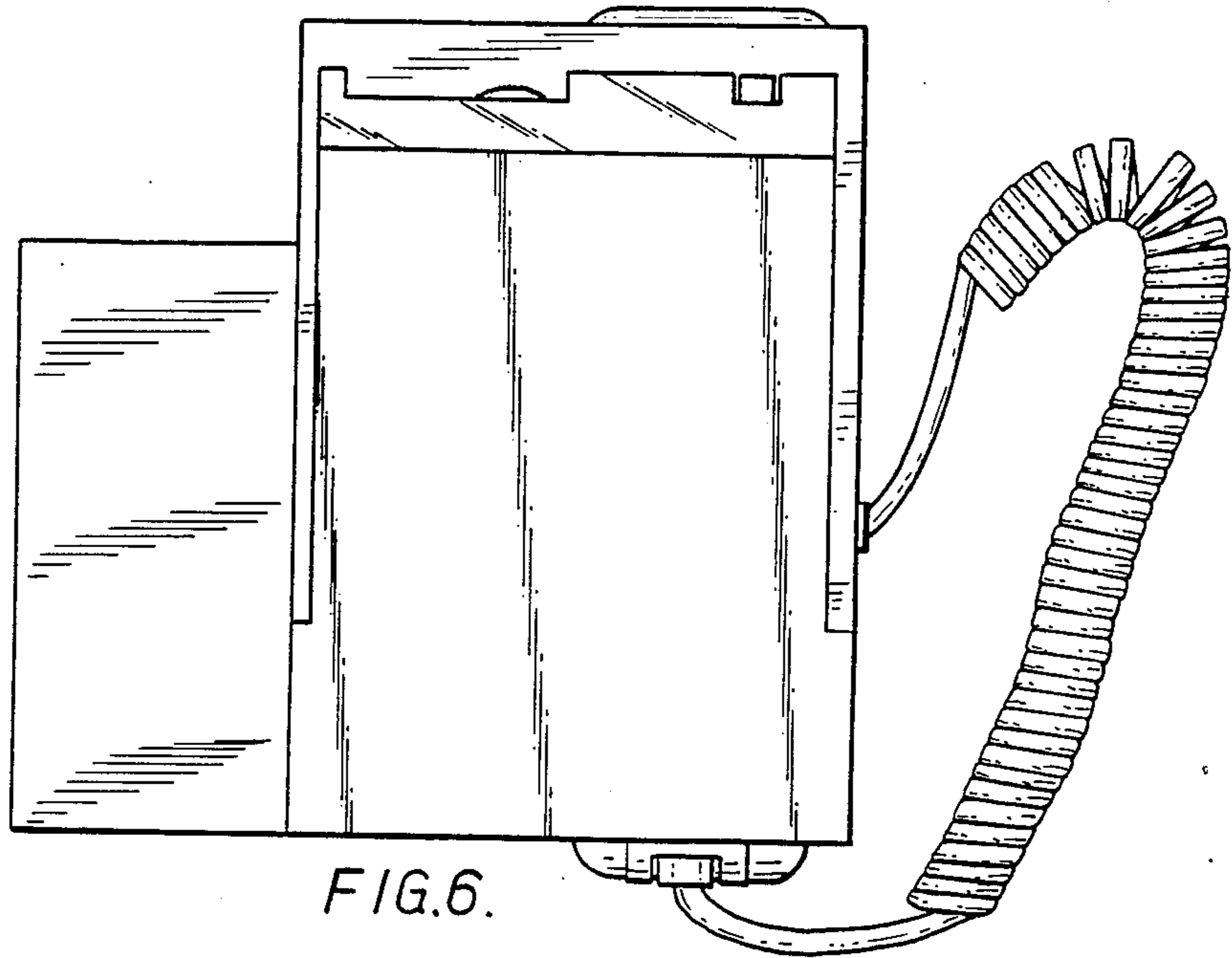
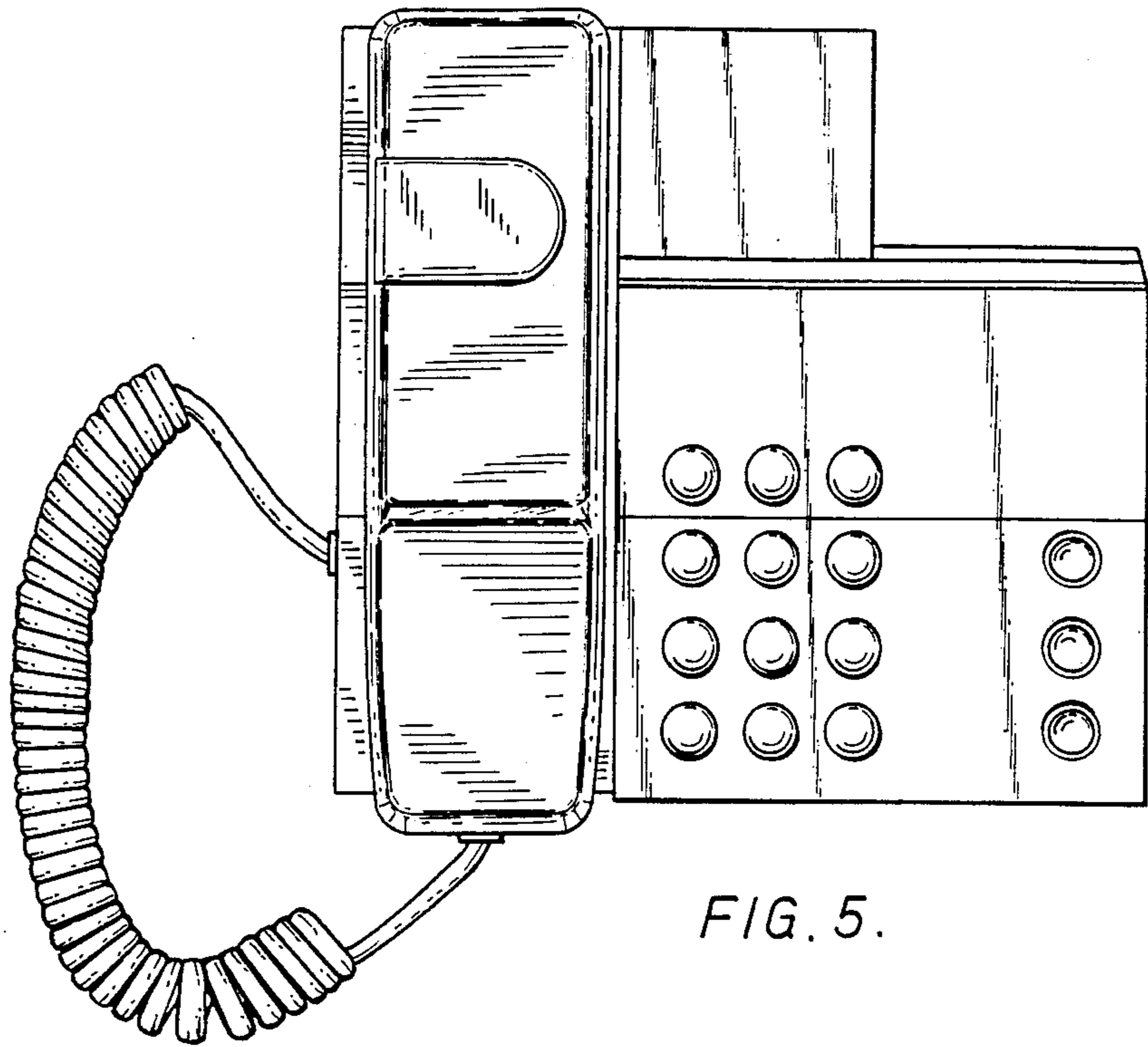

FIG. 4.



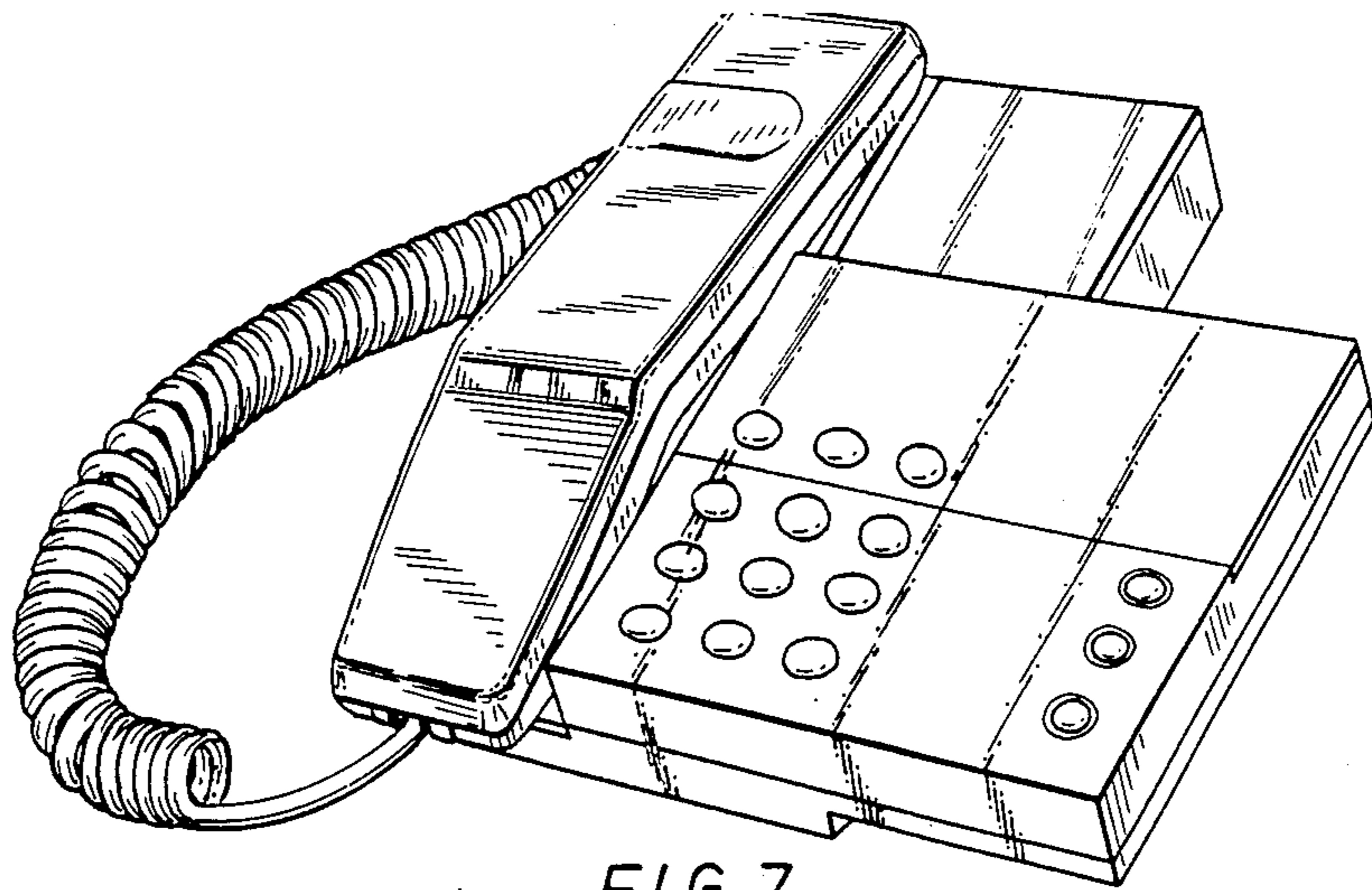

FIG. 7.

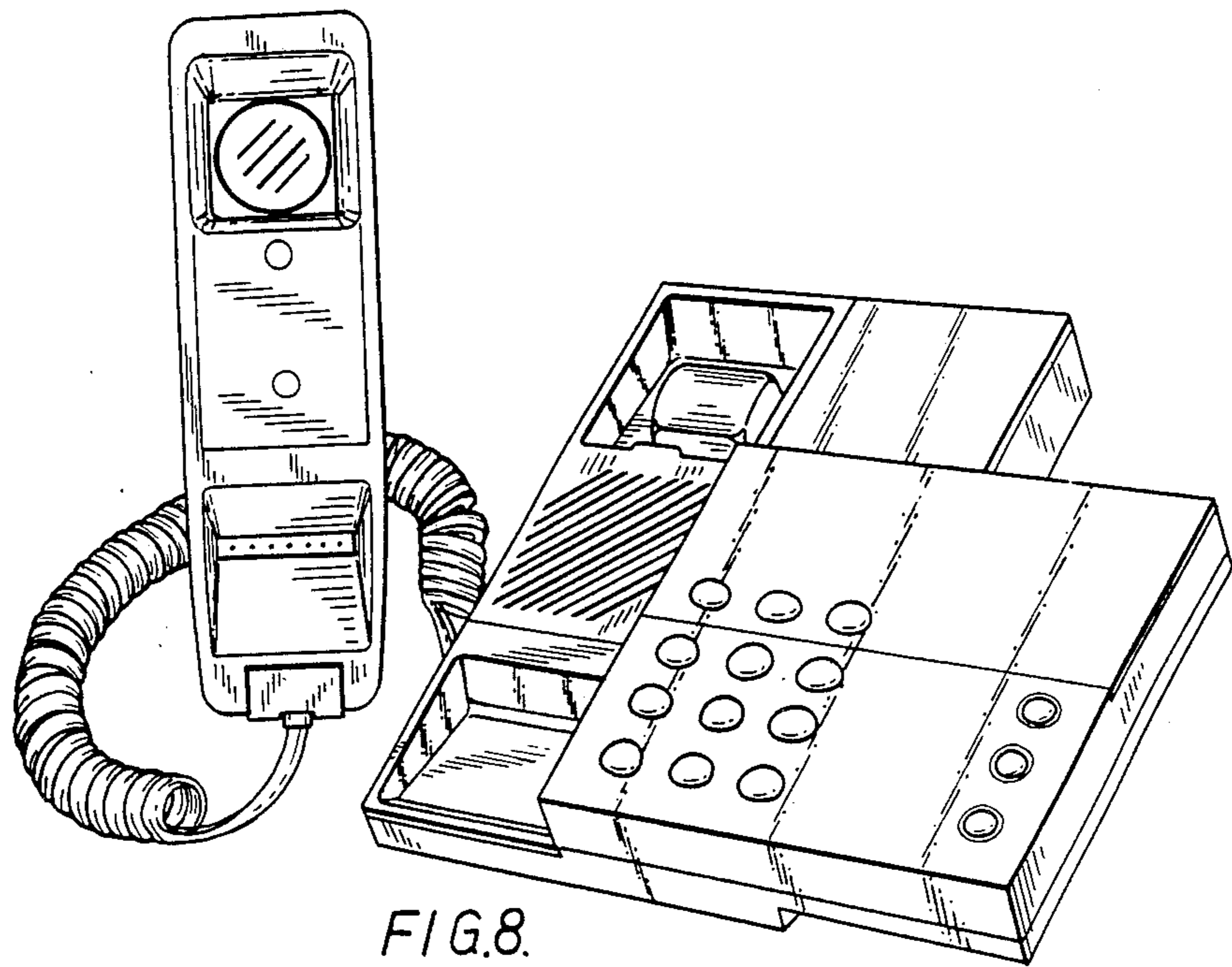

FIG. 8.