

[54] COMBINED REAR SPOILER AND LIGHT

[75] Inventors: Leif H. Chapman, Sylvan Lake; Richard F. Ruzzin, Grosse Pointe, both of Mich.

[73] Assignee: General Motors Corporation, Detroit, Mich.

[**] Term: 14 Years

[21] Appl. No.: 95,935

[22] Filed: Sep. 14, 1987

[52] U.S. Cl. D12/181; D26/34

[58] Field of Search D12/181; D26/34; 296/180.1, 91

[56] References Cited

PUBLICATIONS

Motor Trend, 6/85, p. 45, Rear Spoiler of Camaro GTZ, bottom right side of page.

Motor Trend, 4/86, p. 28, Rear Spoiler & Light of Dodge Daytona, center right side of page.

Motor Trend, 4/86, p. 29, Rear Spoiler of Pontiac Trans Am, center of page.

Primary Examiner—James M. Gandy

Attorney, Agent, or Firm—Herbert Furman

[57] CLAIM

The ornamental design for a combined rear spoiler and light, as shown and described.

DESCRIPTION

FIG. 1 is a perspective view of a combined rear spoiler and light showing our new design it being understood that the fragmentary broken line illustration of an automobile is for illustrative purposes only and forms no part of the claimed design;

FIG. 2 is an enlarged top plan view thereof;

FIG. 3 is a rear elevational view taken along line 3—3 of FIG. 2;

FIG. 4 is a side elevational view taken along line 4—4 of FIG. 2;

FIG. 5 is an enlarged sectional view taken along line 5—5 of FIG. 2;

FIG. 6 is an enlarged sectional view taken along line 6—6 of FIG. 2;

FIG. 7 is an enlarged sectional view taken along line 7—7 of FIG. 2;

FIG. 8 is an enlarged sectional view taken along line 8—8 of FIG. 2;

FIG. 9 is an enlarged sectional view taken along line 9—9 of FIG. 2; and

FIG. 10 is an enlarged sectional view taken along line 10—10 of FIG. 2.

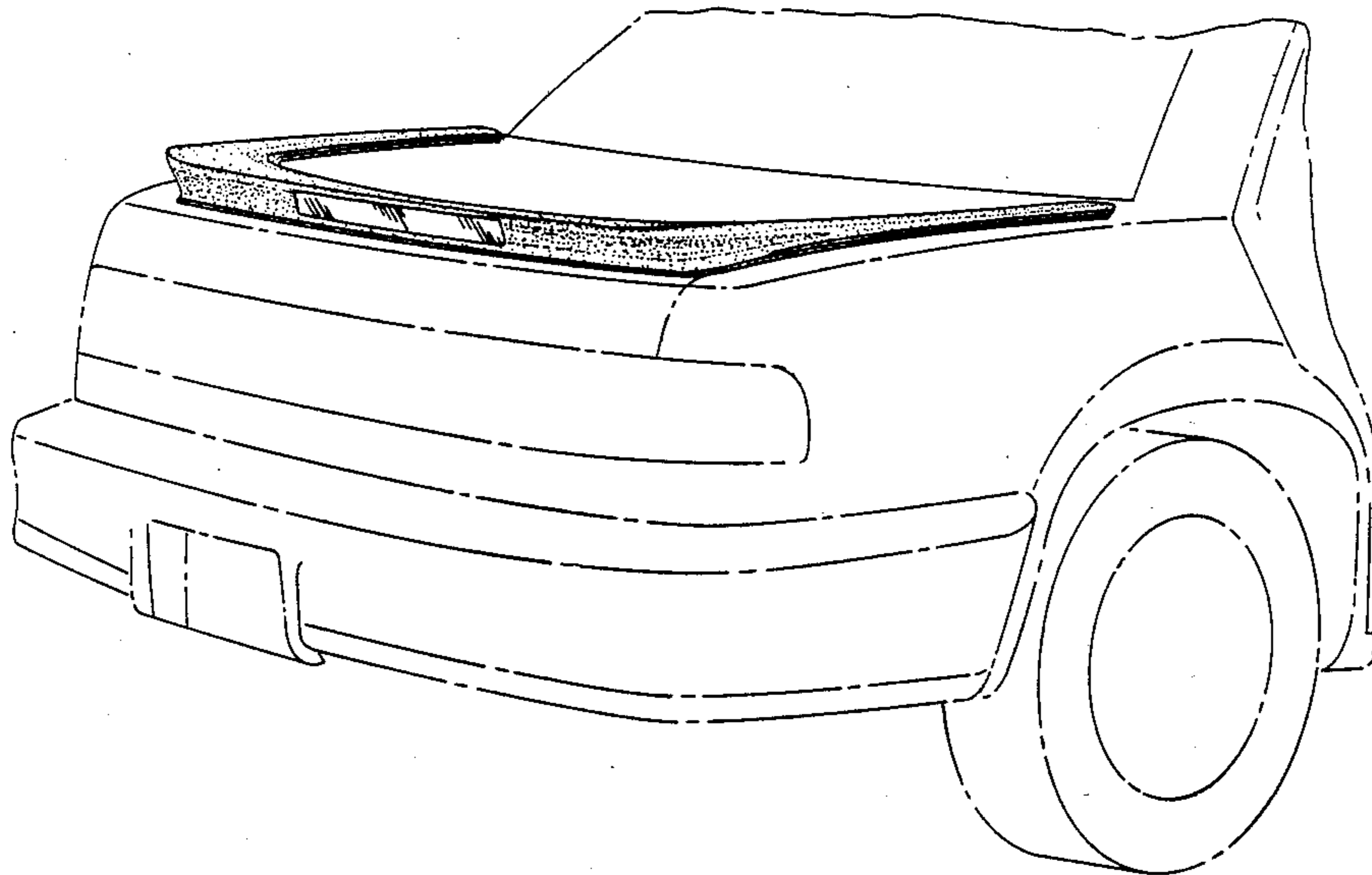

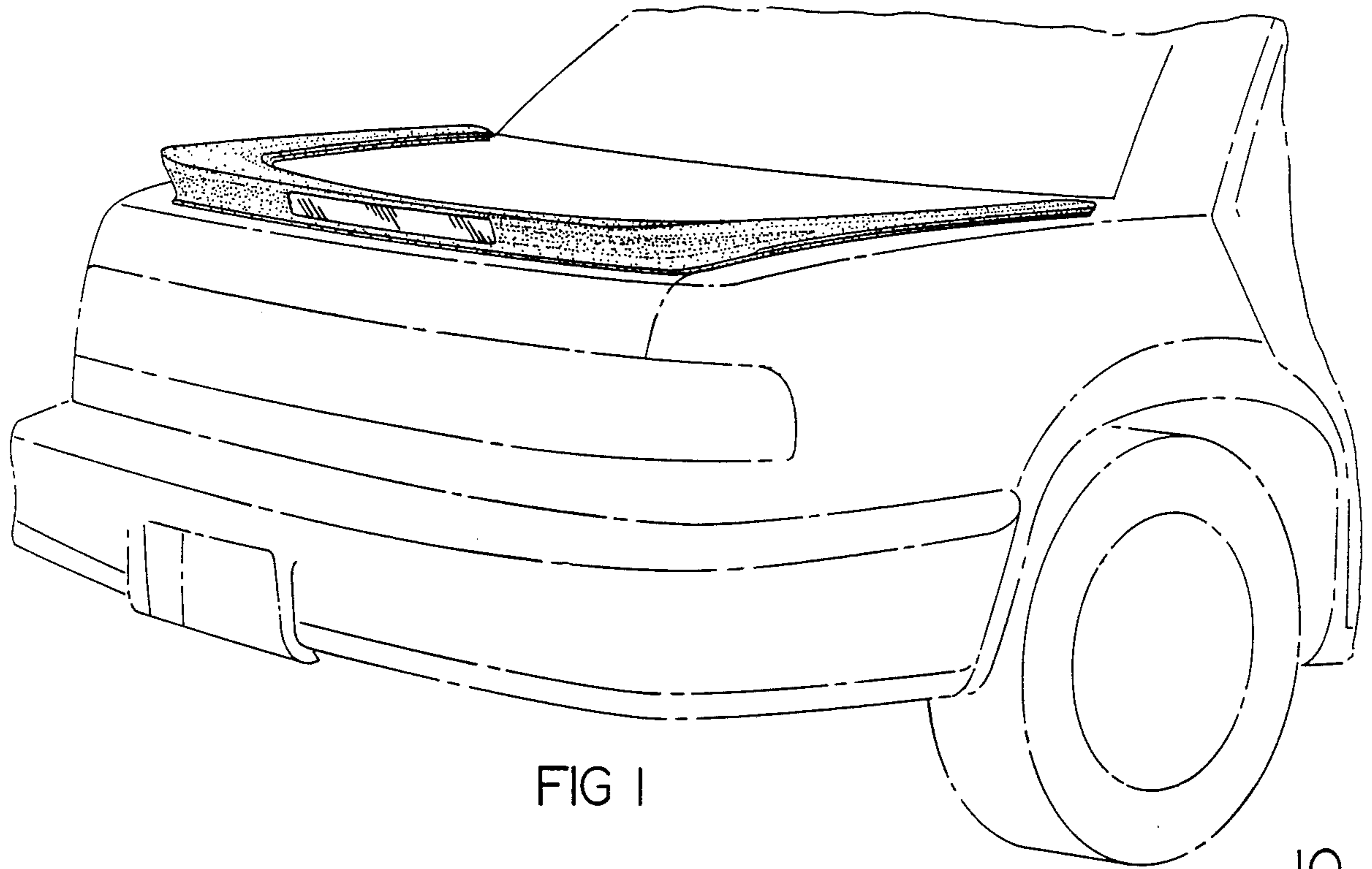

FIG 1

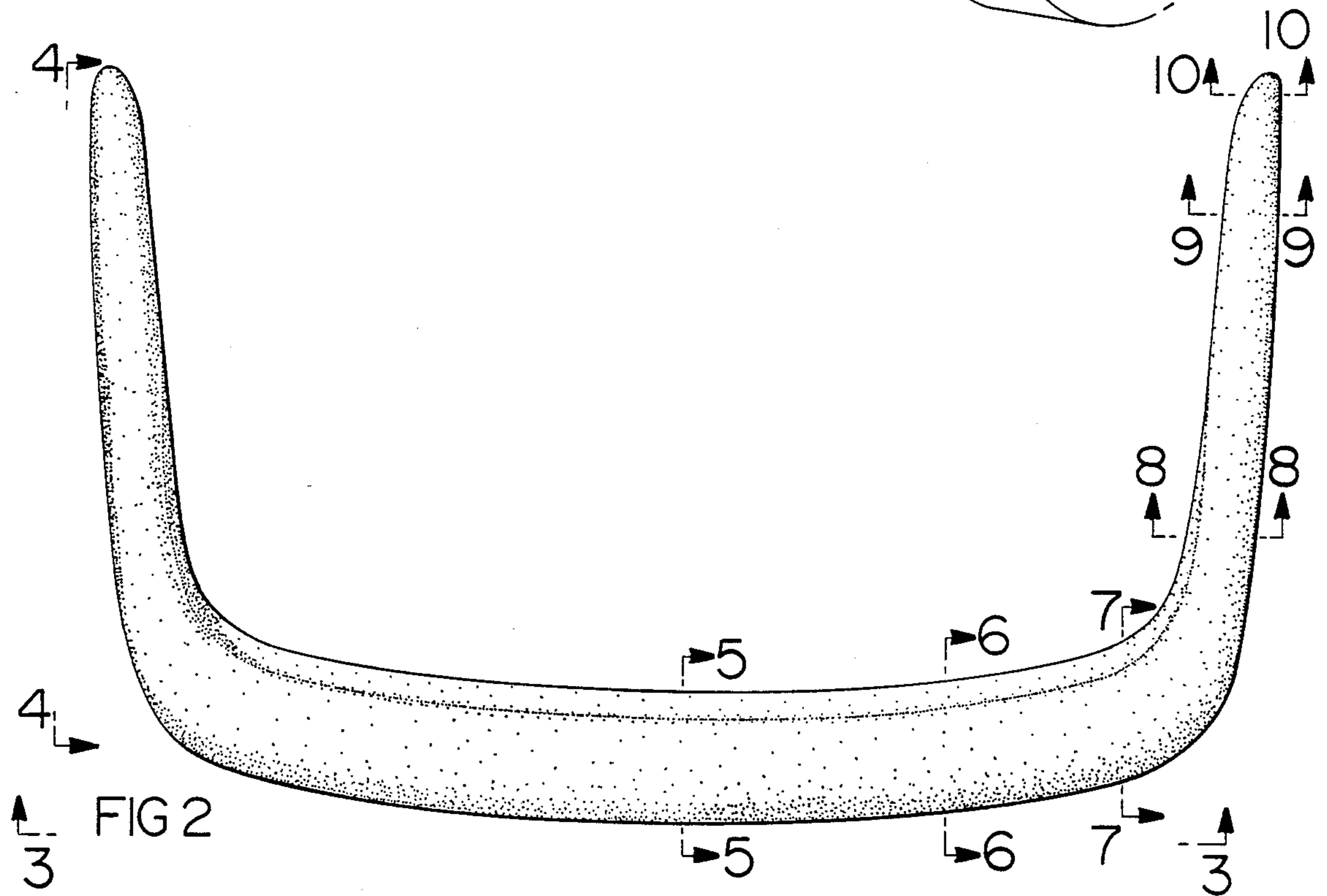

FIG 2



FIG 3

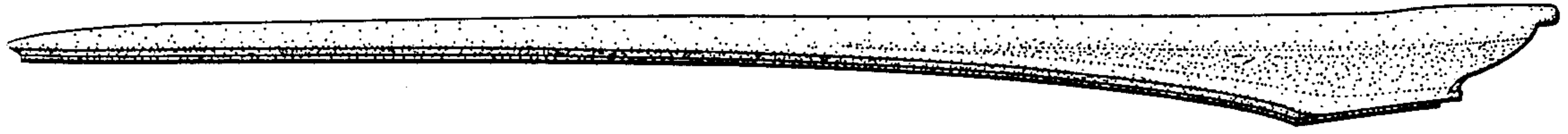

FIG 4

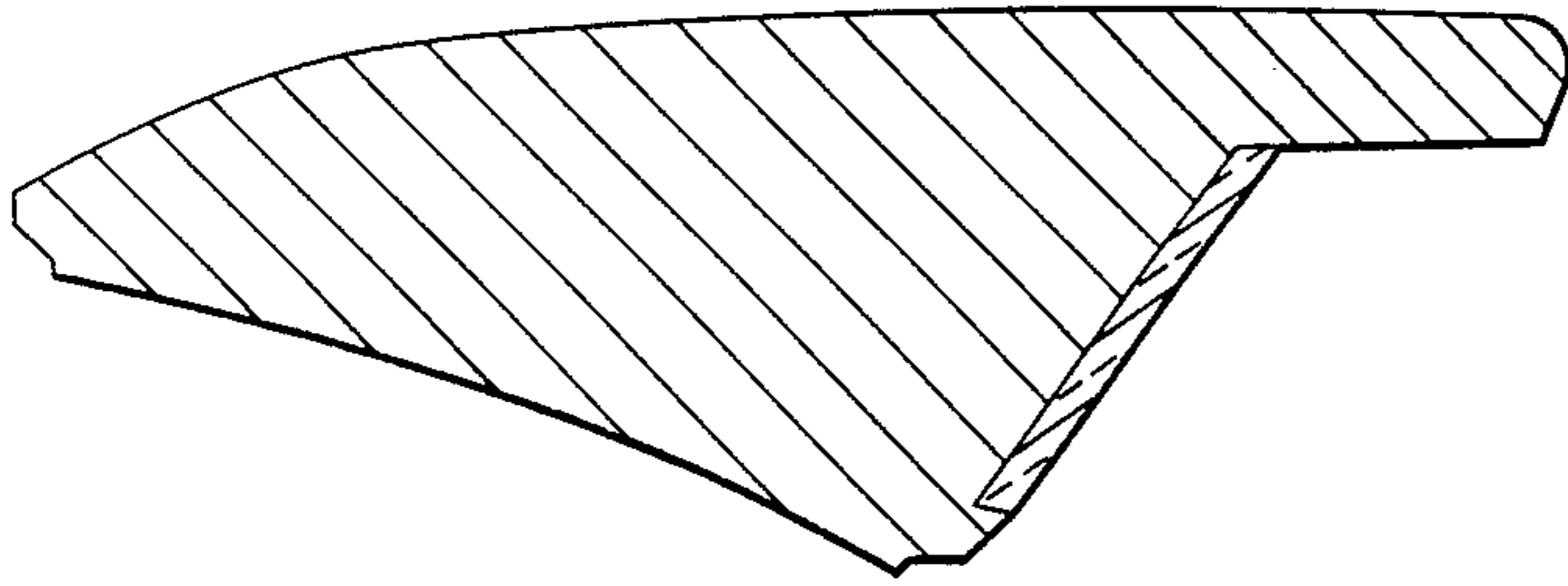

FIG 5

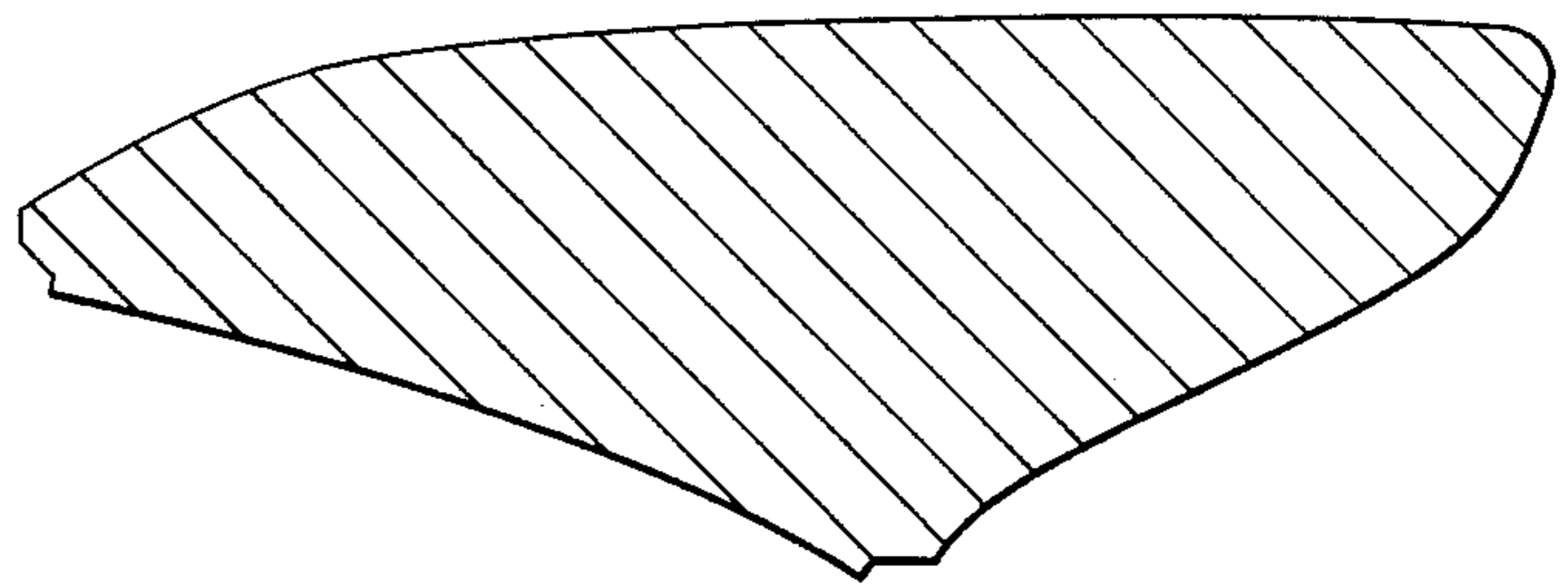

FIG 6

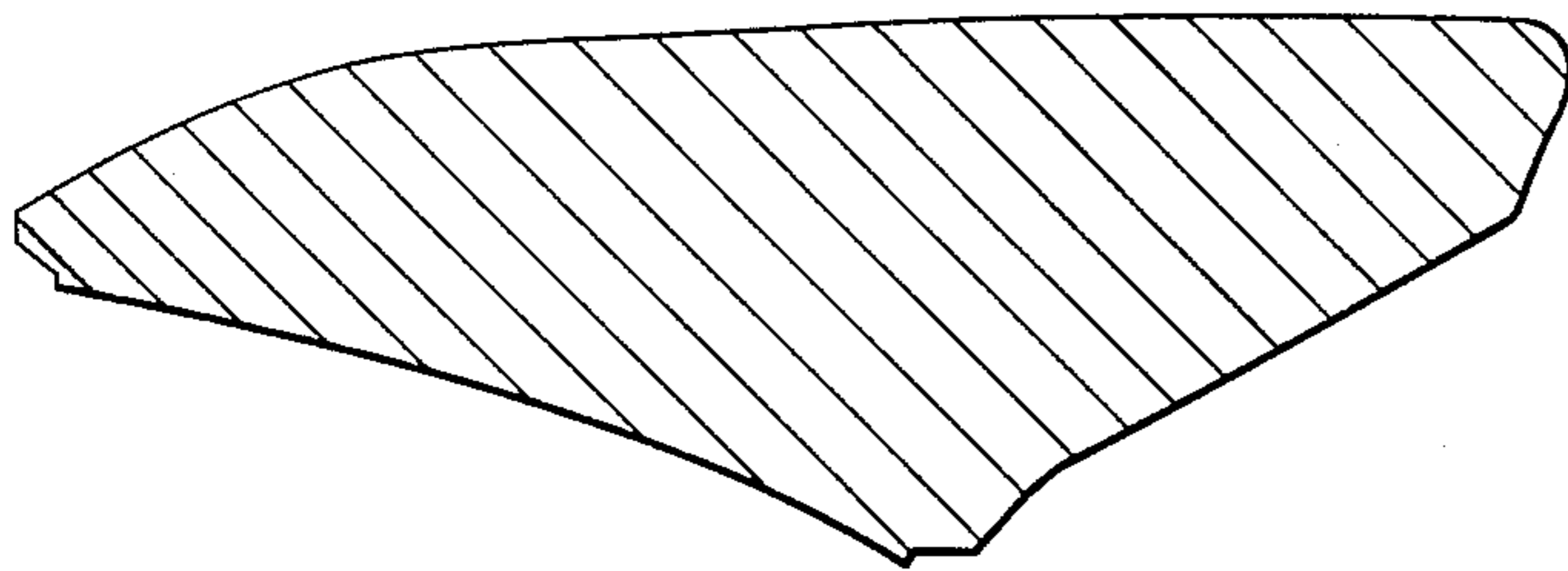

FIG 7

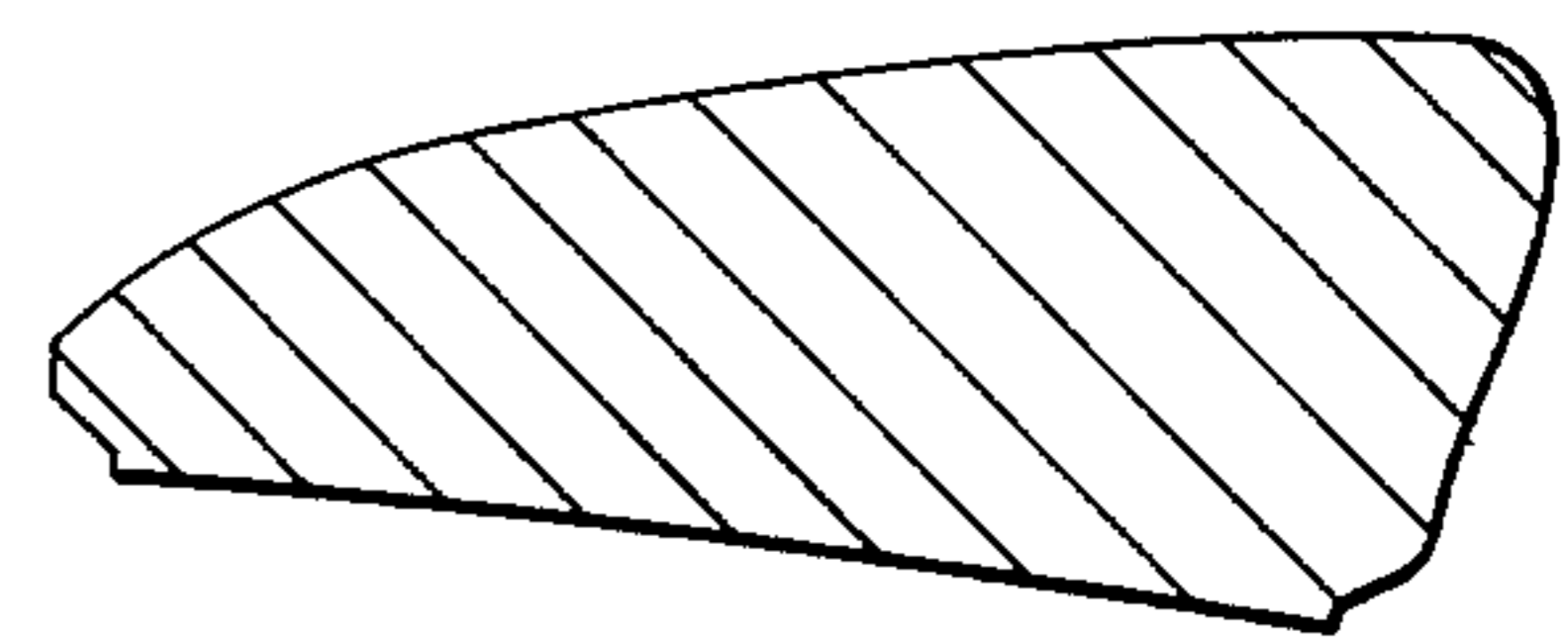

FIG 8

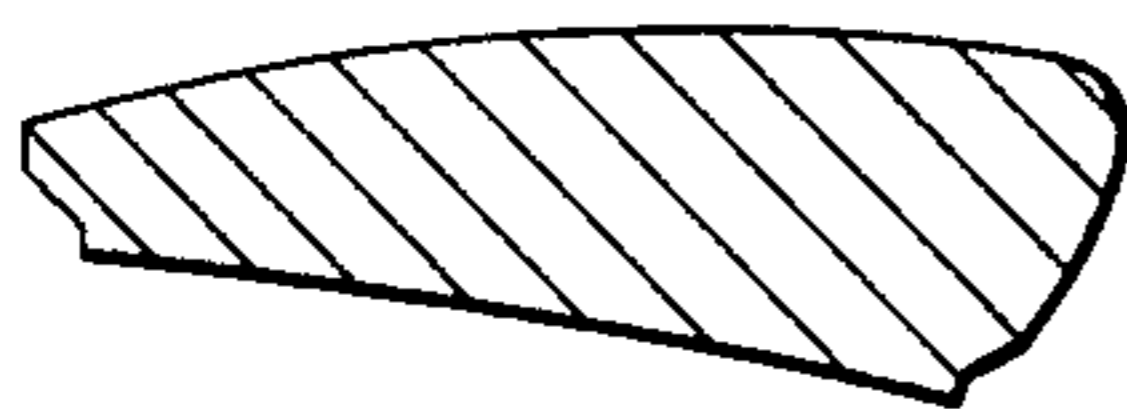

FIG 9

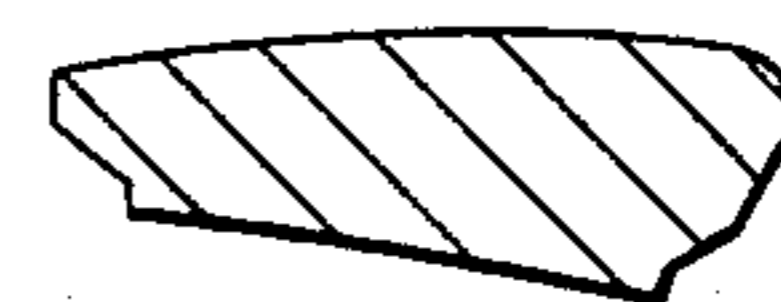

FIG 10