

[54] EXPANSION BRACELET

[75] Inventor: Murray L. Cowan, Norwood, Mass.

[73] Assignee: Textron Inc., Del.

[**] Term: 14 Years

[21] Appl. No.: 77,403

[22] Filed: Jul. 20, 1987

[52] U.S. Cl. D11/25; D11/19

[58] Field of Search D11/1, 3, 4, 19, 20,
D11/25, 93-94, 17; 63/1.1, 26; 59/78,
79.1-79.3, 80-82, 84

[56] References Cited

U.S. PATENT DOCUMENTS

D. 161,189	12/1950	Knibb	D11/20
D. 221,017	6/1971	Poon	D11/17
D. 238,808	2/1976	Cowan	D11/25
D. 243,114	1/1977	Cowan	D11/93
253,587	2/1882	Crane	63/1.1

Primary Examiner—Louis S. Zarfes

Assistant Examiner—R. T. Seifert

Attorney, Agent, or Firm—Samuels, Gauthier, Stevens & Kehoe

[57] CLAIM

The ornamental design for an expansion bracelet, as shown and described.

DESCRIPTION

FIG. 1 is a top plan view of an expansion bracelet showing my new design;

FIG. 2 is a bottom plan view thereof with the central portion broken away for ease of illustration;

FIG. 3 is a side elevational view thereof, again with the central portion broken away for ease of illustration;

FIG. 4 is an end view thereof;

FIG. 5 is an enlarged partial top plan view thereof showing several links in the expanded condition;

FIG. 6 is an enlarged partial side elevational view thereof in the expanded condition;

FIG. 7 is a sectional view thereof taken along line 7—7 of FIG. 6; and

FIG. 8 is a perspective view thereof showing several links intermediate the ends of the bracelet.

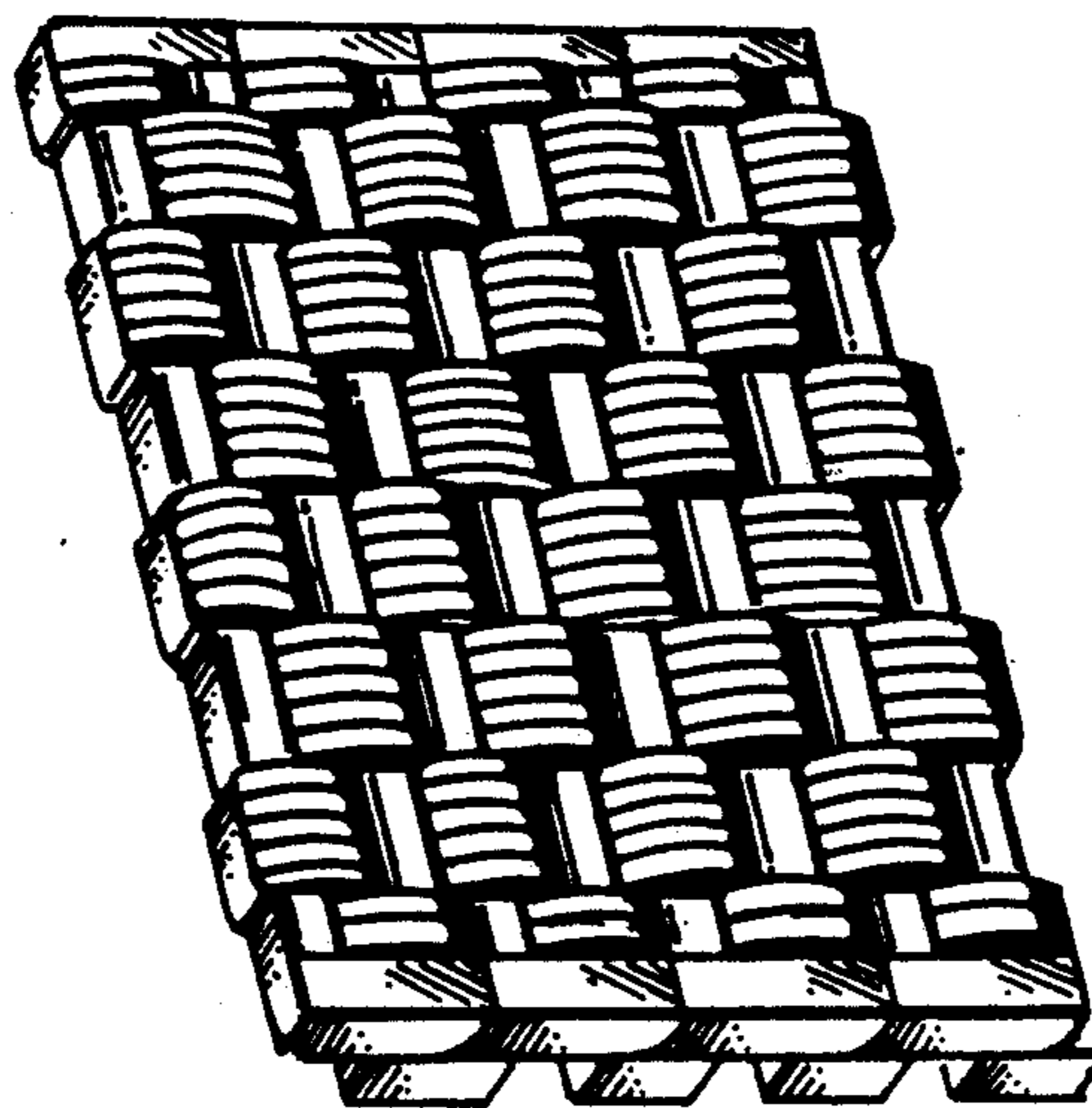

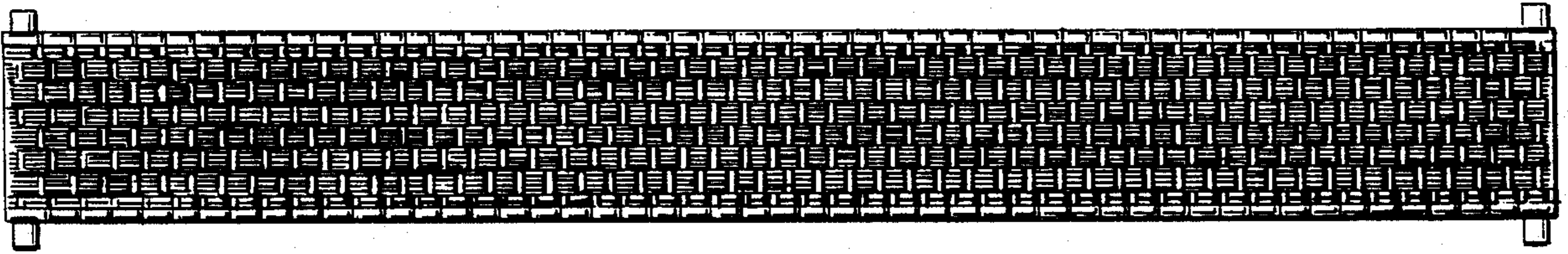

FIG. 1

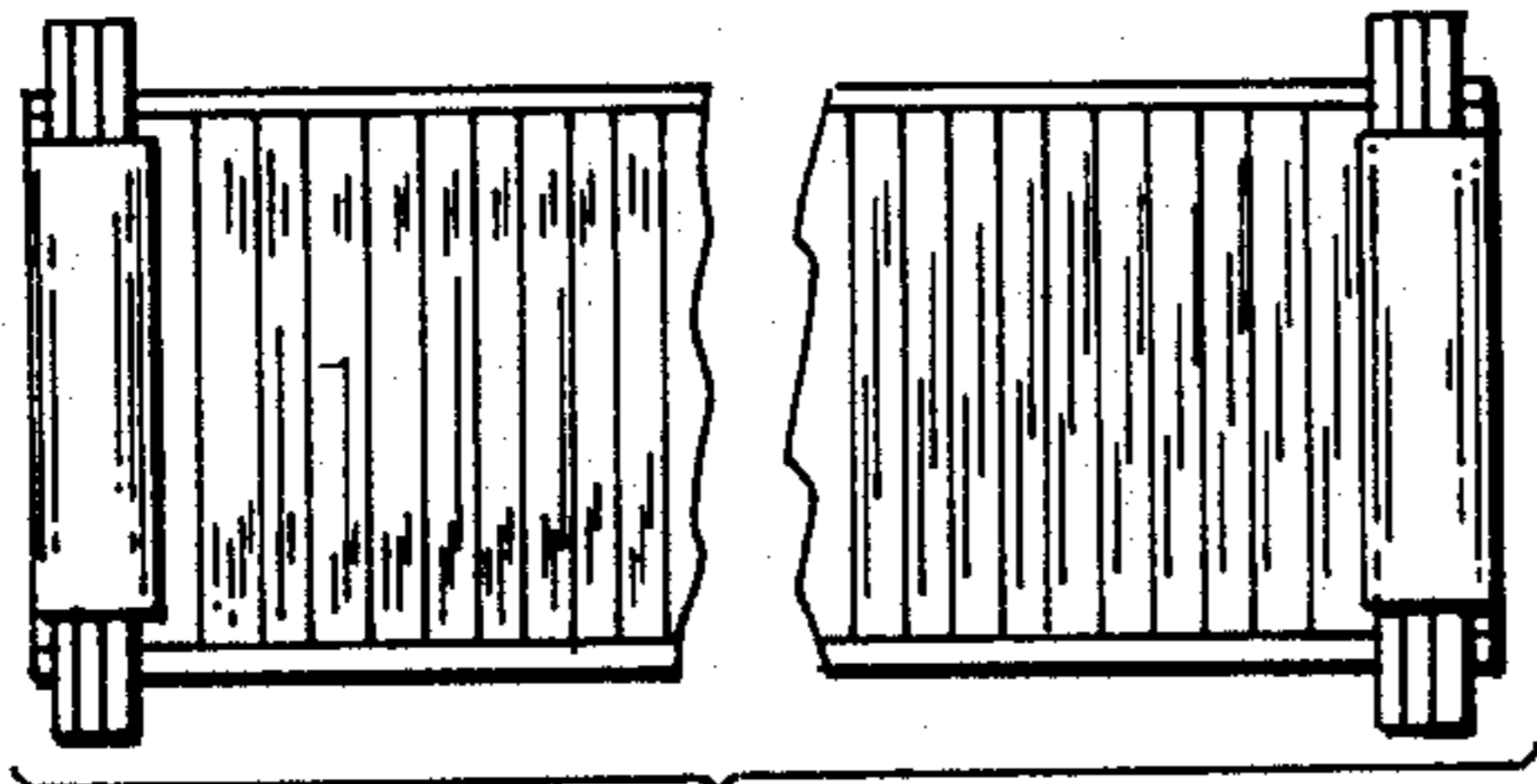

FIG. 2



FIG. 4

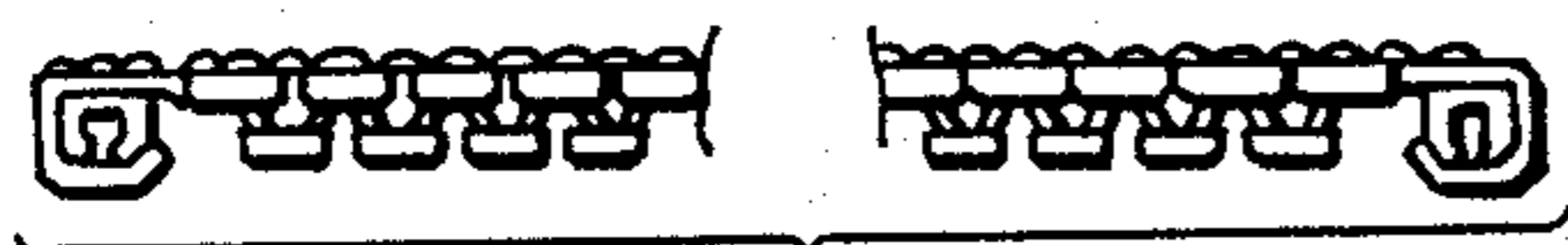

FIG. 3

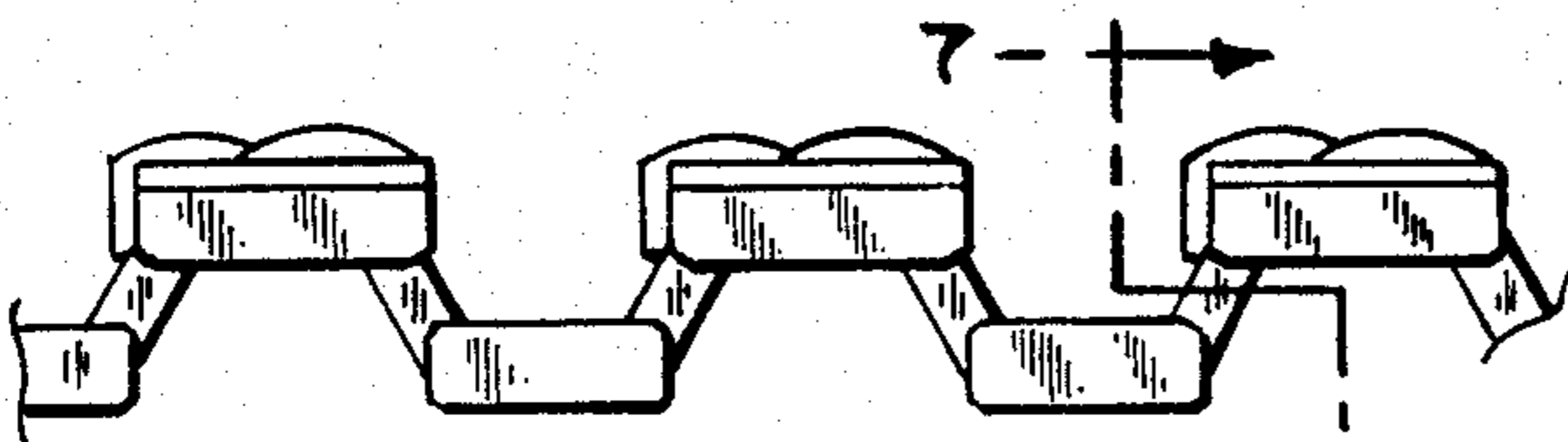

FIG. 6

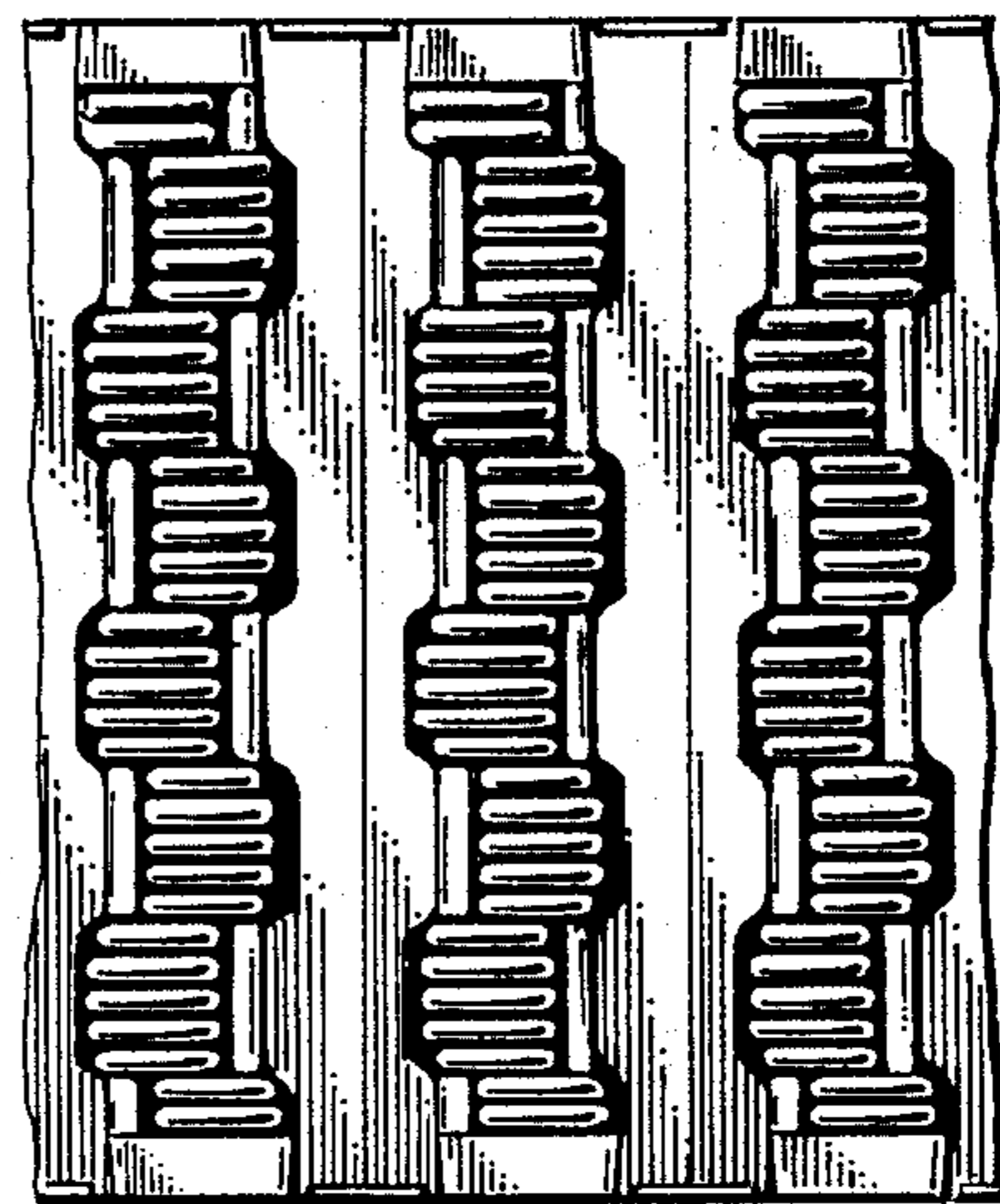

FIG. 5



FIG. 7

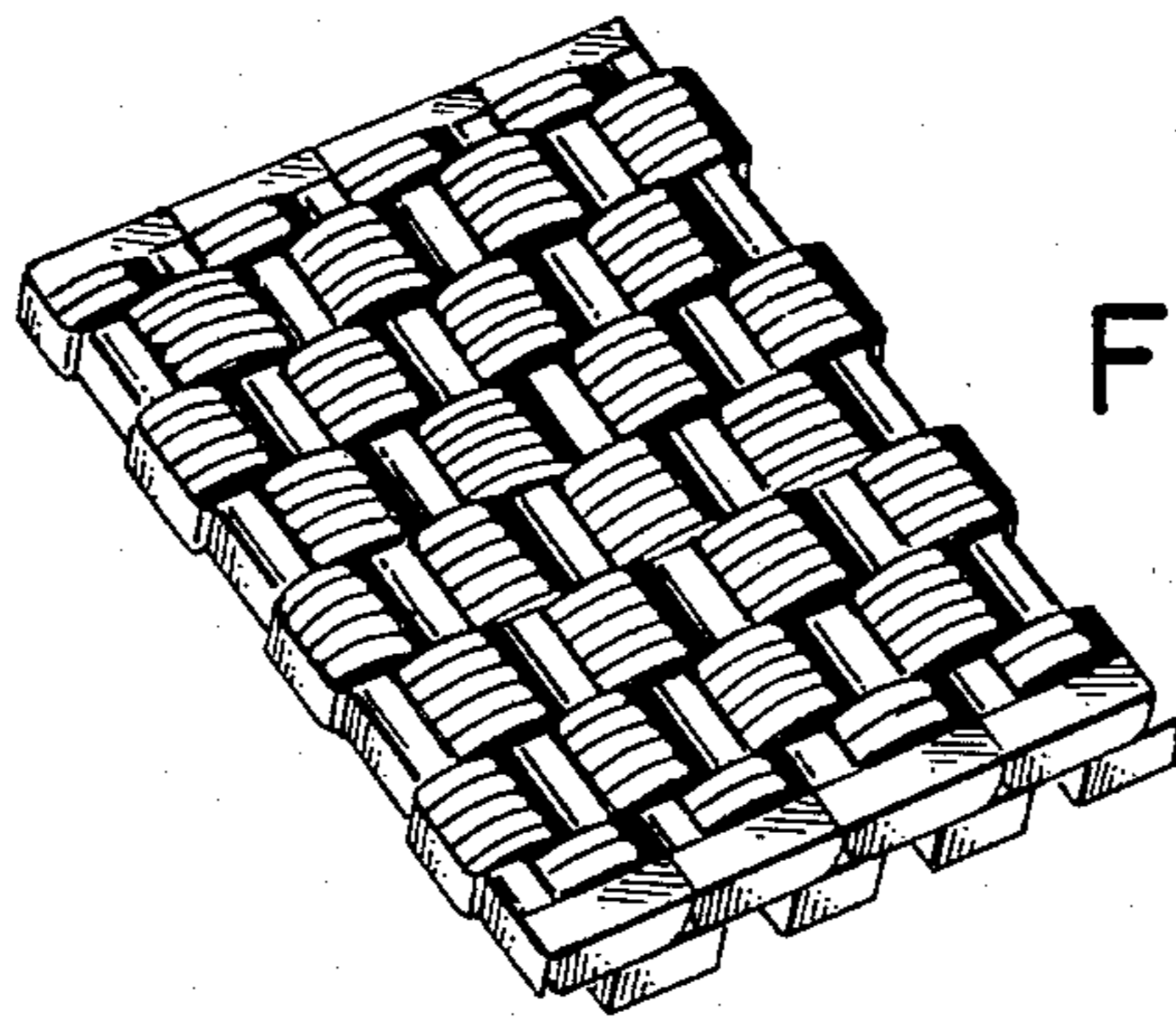

FIG. 8