

United States Patent [19]

Carlson

[11] Patent Number: **Des. 304,680**

[45] Date of Patent: **** Nov. 21, 1989**

[54] **CONTAINER FOR BOTTLES**

[76] Inventor: **Arthur R. Carlson, 401A Waverley Road, East Malvern, Victoria, 3145, Australia**

[**] Term: **14 Years**

[21] Appl. No.: **58,533**

[22] Filed: **Jun. 5, 1987**

[52] U.S. Cl. **D9/341**

[58] Field of Search **D9/341, 345, 347, 369, D9/455; 206/139, 427, 216, 461, 538, 169, 162; 220/20, 4 R, 21, 4 B, 71, 94 B, 83; D7/71, 78, 77, 81**

[56] **References Cited**

U.S. PATENT DOCUMENTS

- D. 128,124 7/1941 Melville D7/71
- D. 244,823 6/1977 Lass D7/78
- D. 255,574 6/1980 Carver D9/341 X
- D. 257,549 11/1980 Chapman D7/77 X
- D. 278,128 3/1985 VanDine et al. D9/455

- D. 287,336 12/1986 Roehrig D9/341
- D. 288,411 2/1987 Castellanet D9/455
- 1,290,965 1/1919 Gallaher 206/461
- 4,721,216 1/1988 Kinder D9/455 X

Primary Examiner—Bernard Ansher
Assistant Examiner—Prabhakar Deshmukh
Attorney, Agent, or Firm—Richard Bushnell

[57] **CLAIM**

The ornamental design for a container for bottles, as shown and described.

DESCRIPTION

FIG. 1 is a front and top side perspective view of a container for bottles showing my new design;
FIG. 2 is a rear and bottom side perspective view thereof;
FIG. 3 is a front elevation thereof, the rear side elevation is similar to the front elevation shown;
FIG. 4 is a bottom plan view thereof;
FIG. 5 is a left side elevation thereof, the right side elevation is similar to the left side elevation shown; and
FIG. 6 is a sectional view taken at line 6—6 of FIG. 1.

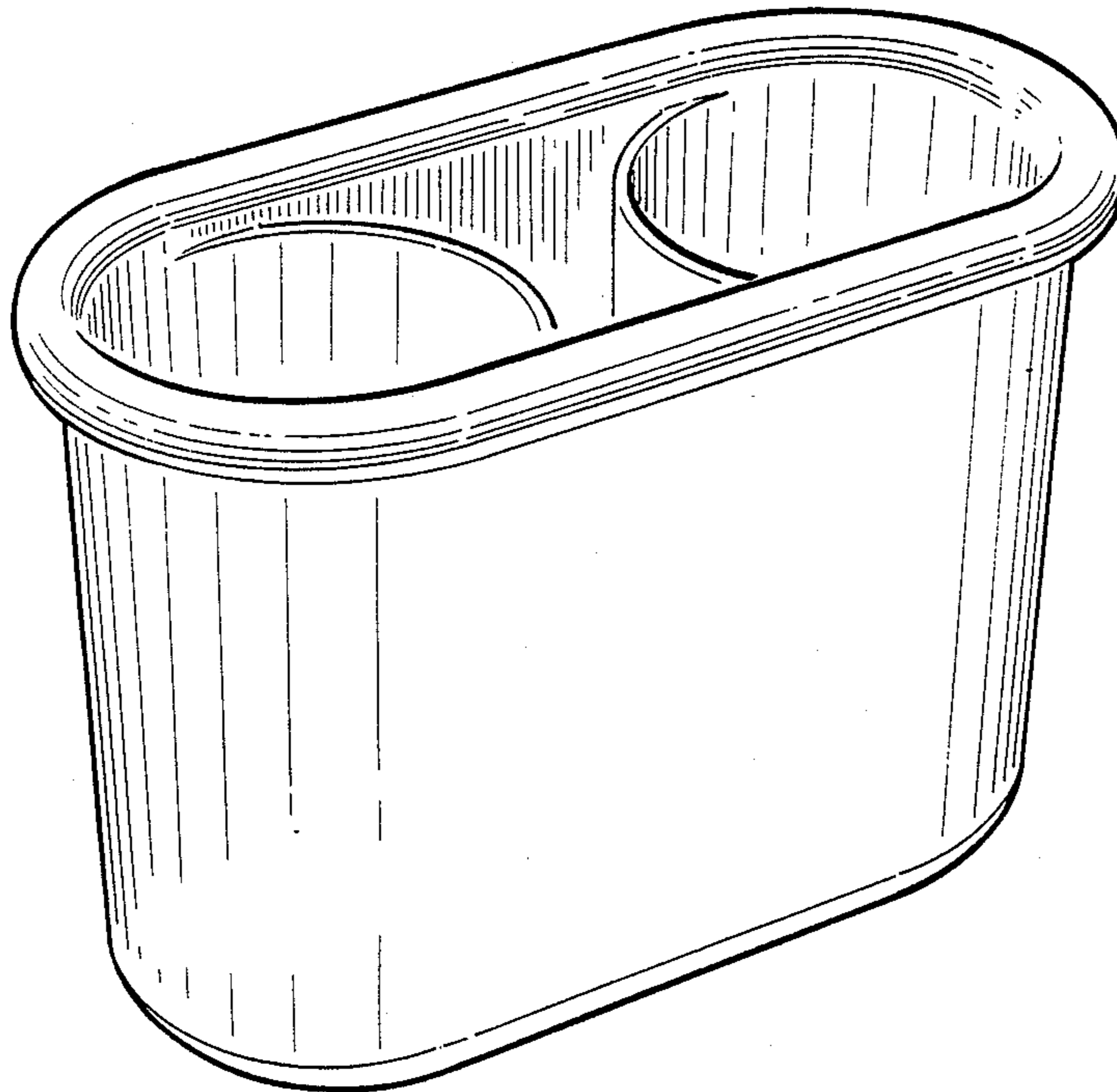

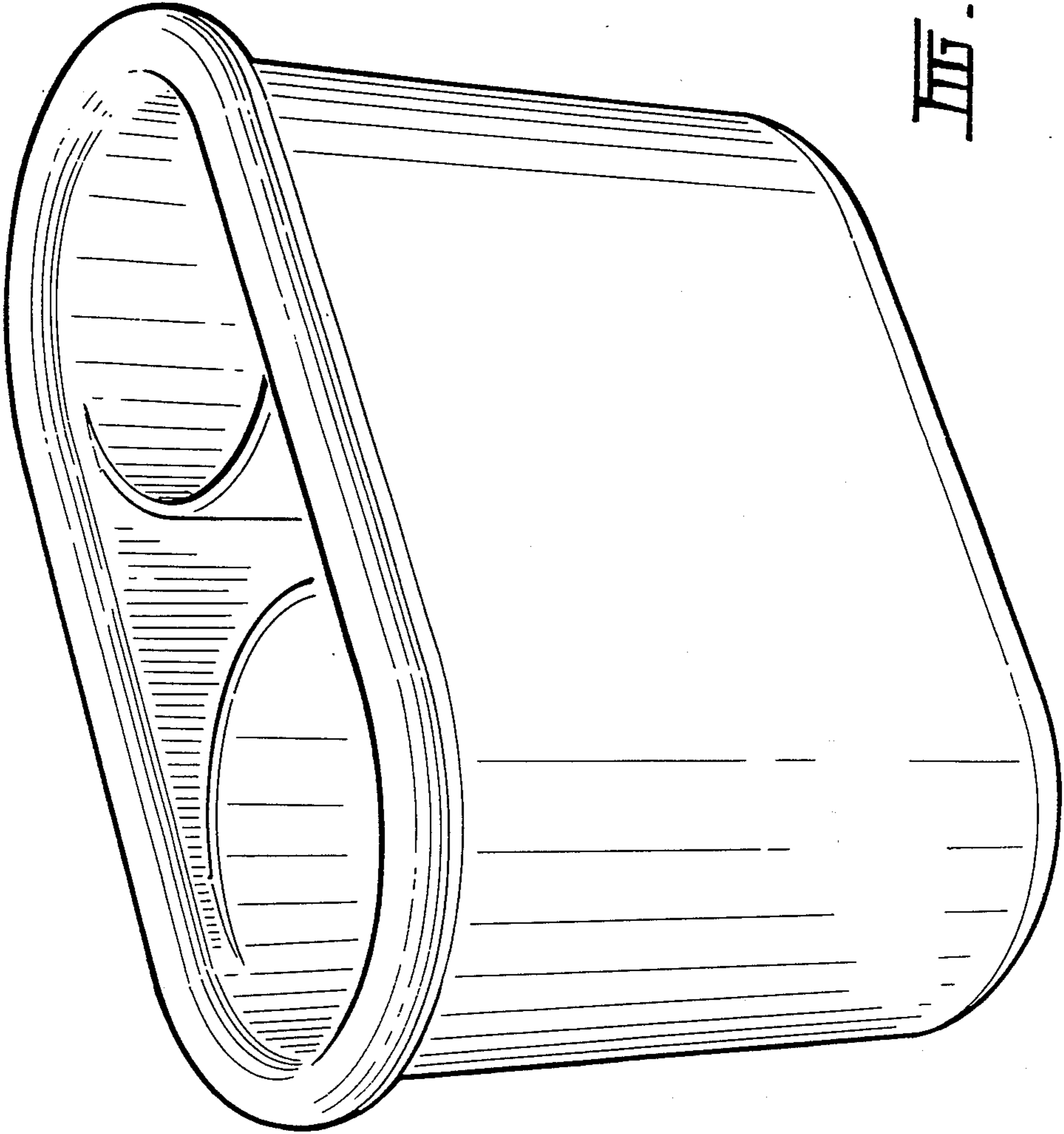
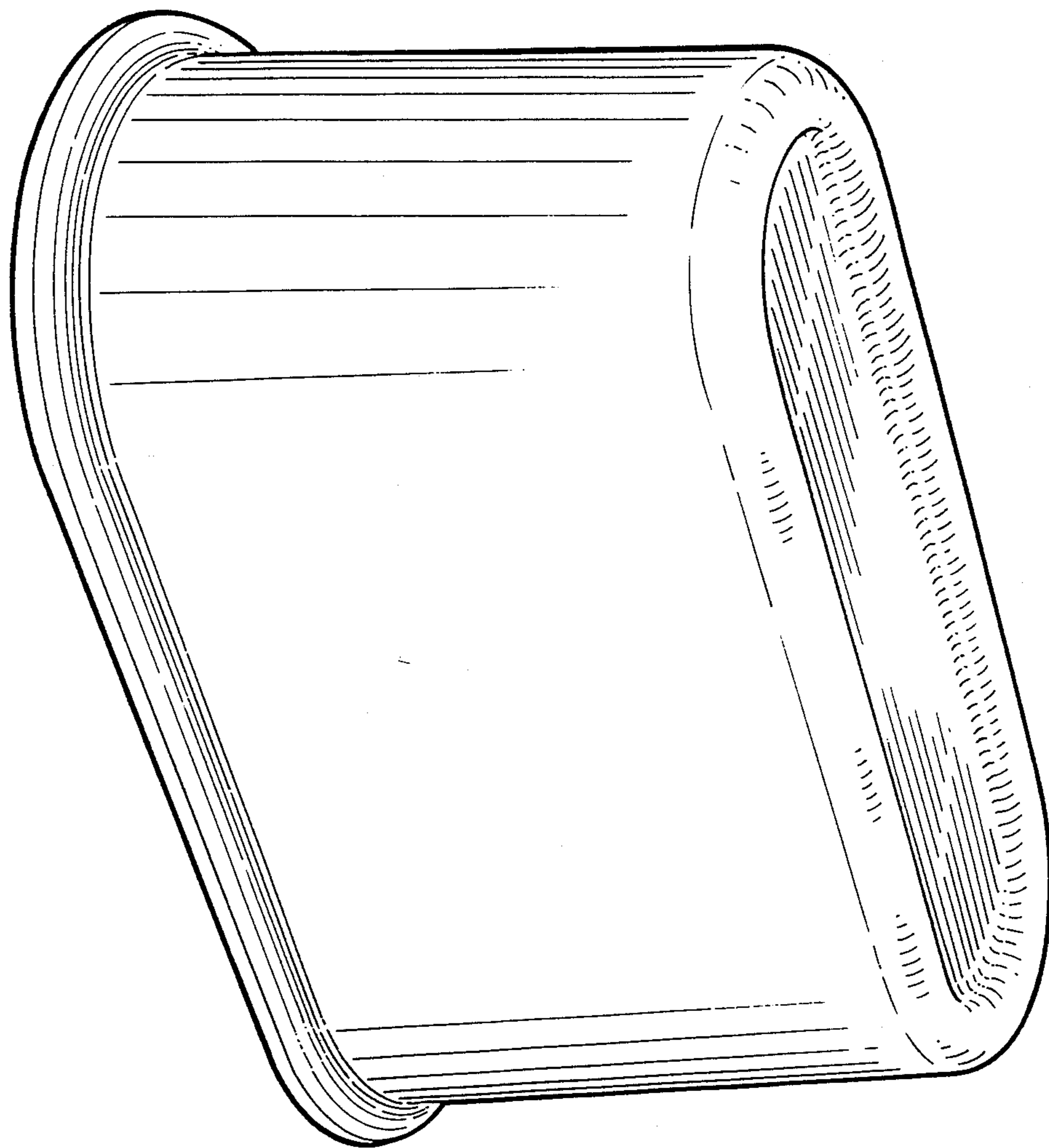
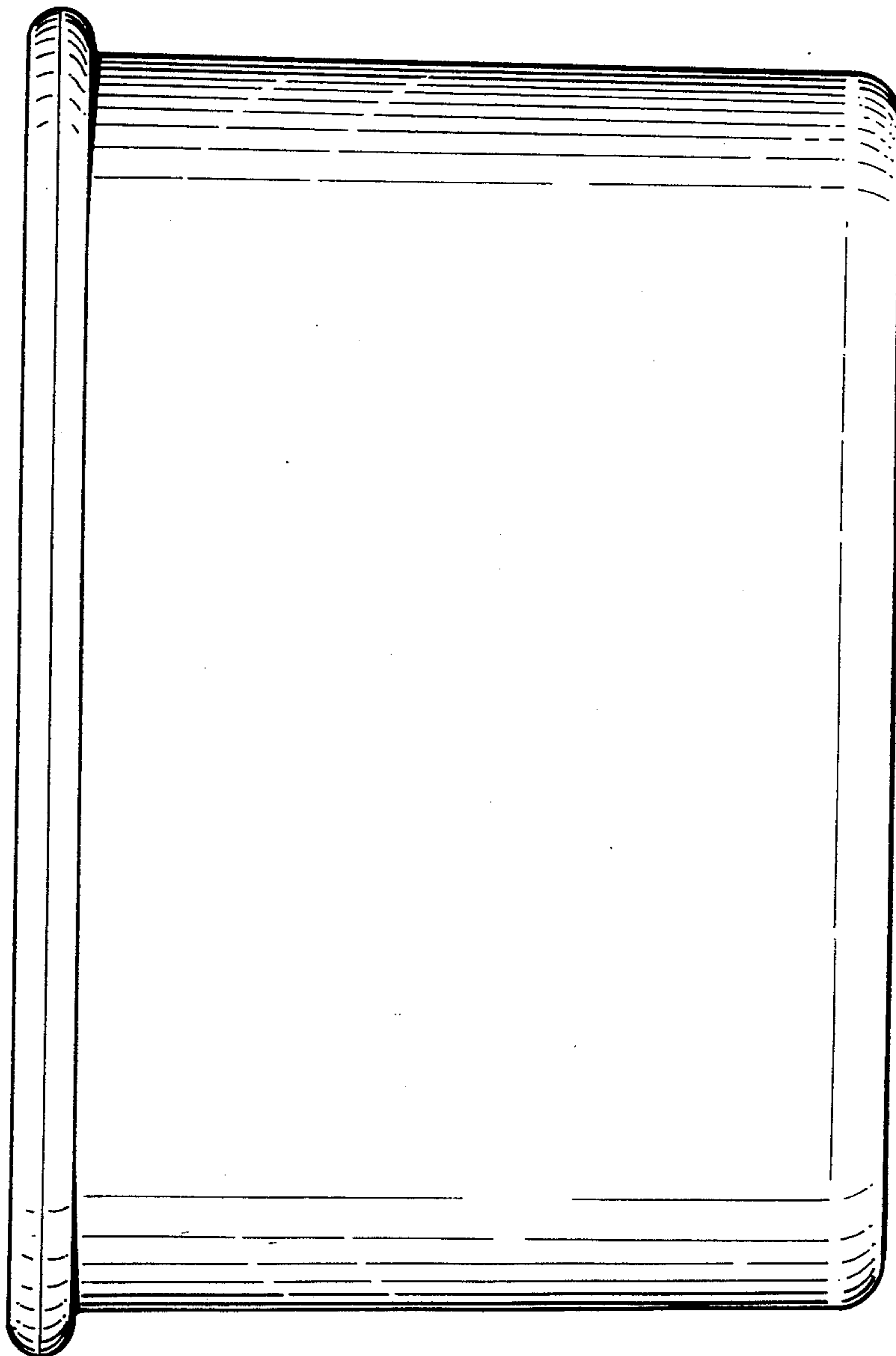

FIG. 1

FIG. 2-





III. 3.

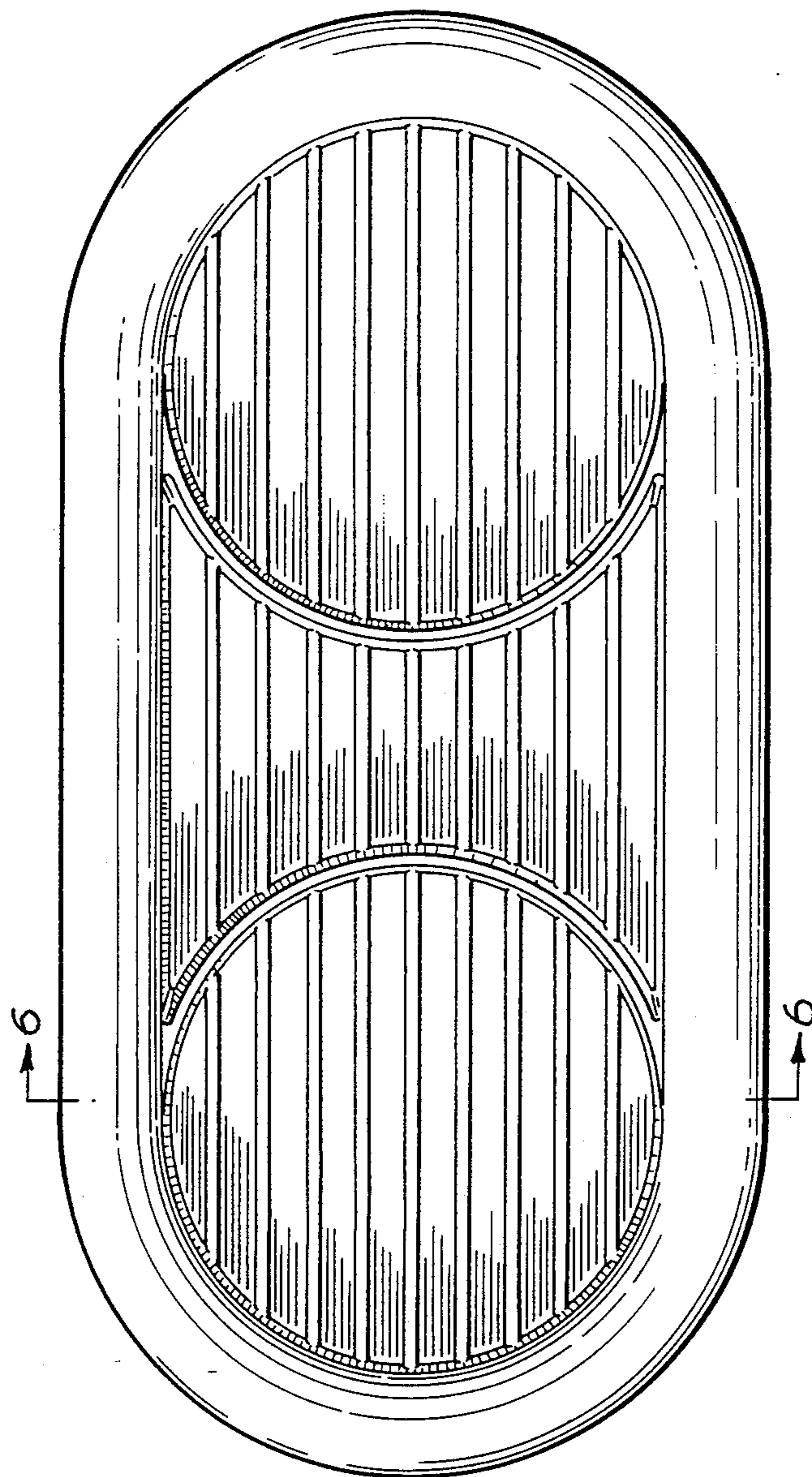

III - A .

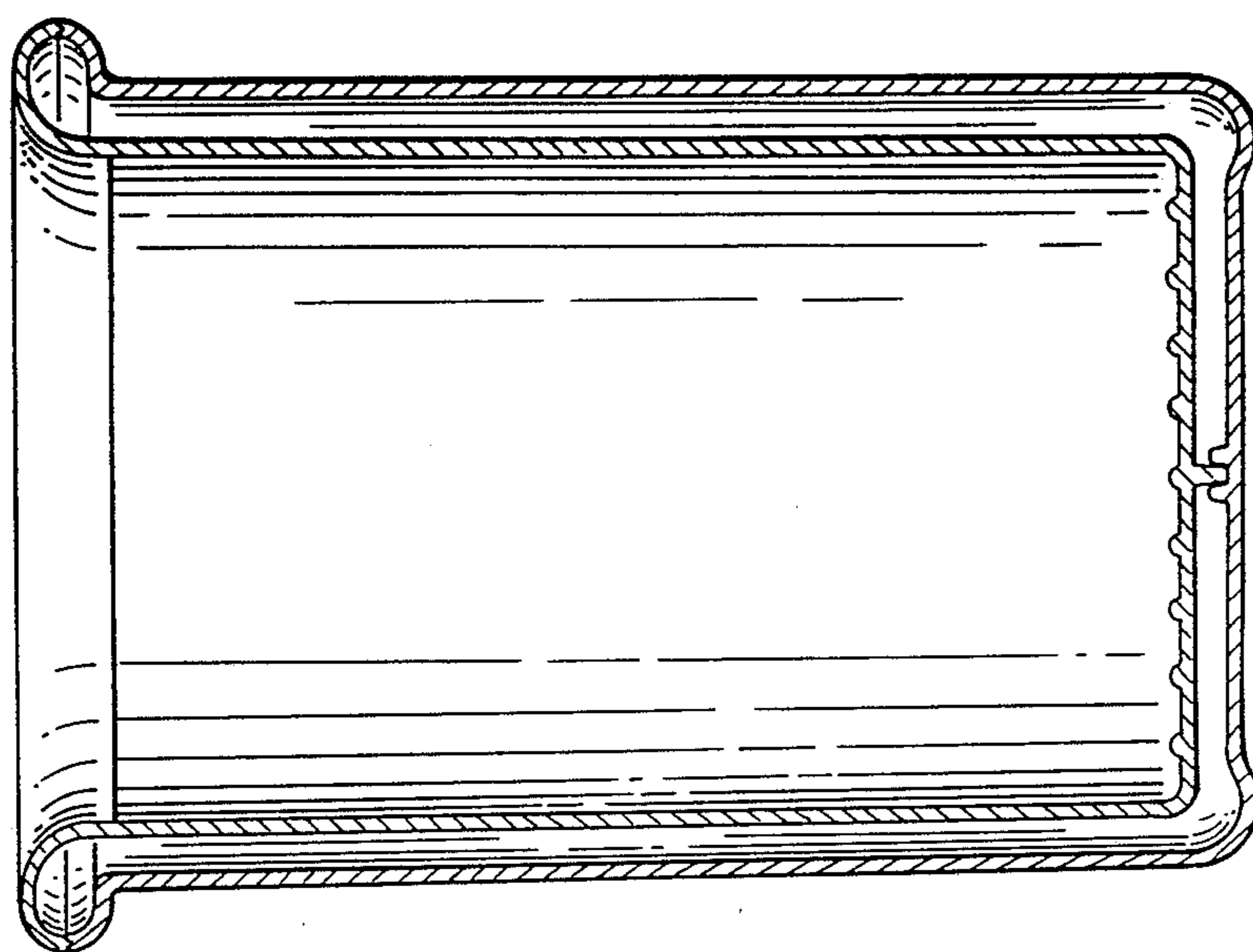

FIG. 6.

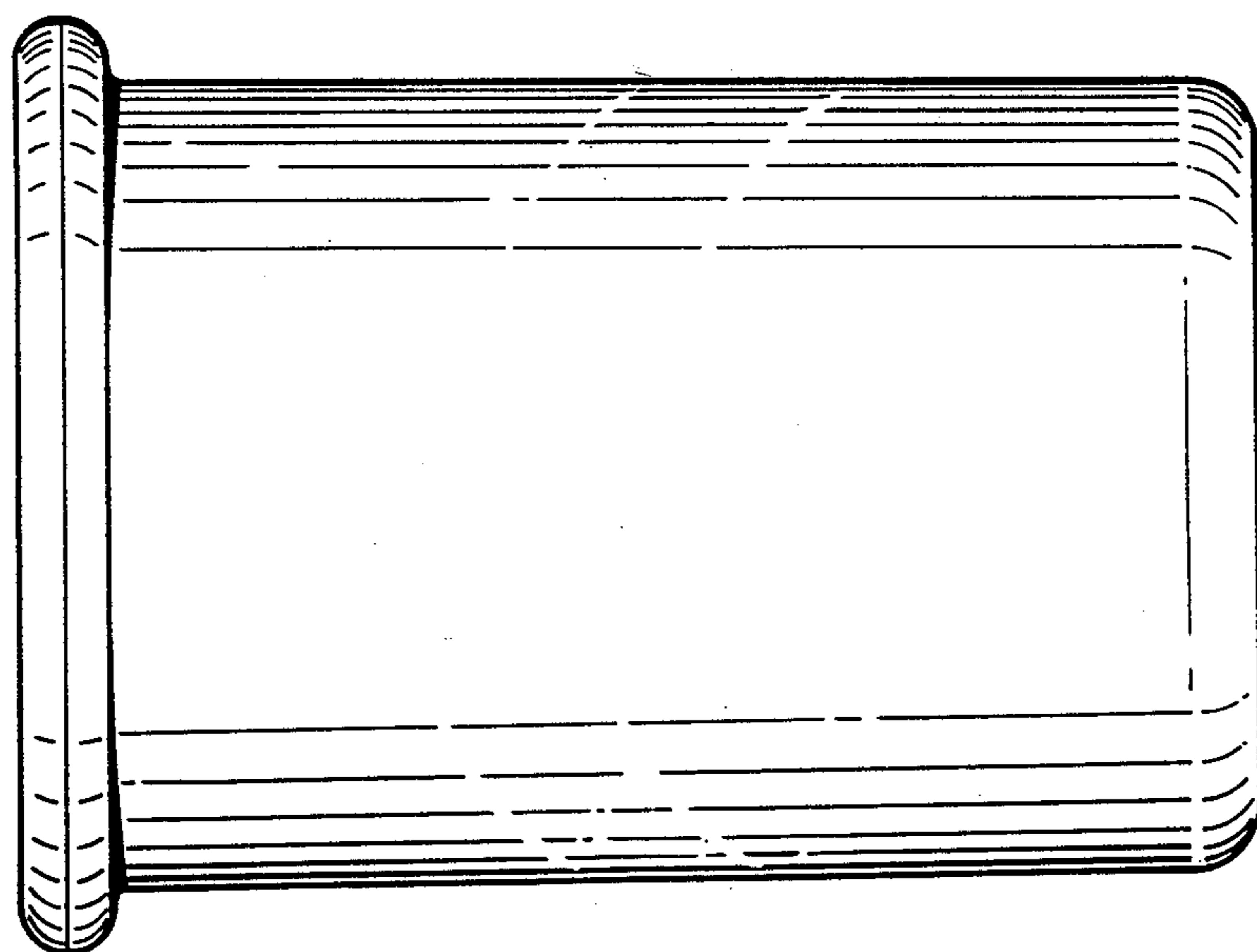

FIG. 5.