

[54] **AUXILIARY HEADLAMP FOR MOTOR VEHICLES**

[75] **Inventor: Gerd Schmidt, Velbert, Fed. Rep. of Germany**

[73] **Assignee: Hella KG Hueck & Co., Lippstadt, Fed. Rep. of Germany**

[\*\*] **Term: 14 Years**

[21] **Appl. No.: 168,733**

[22] **Filed: Mar. 15, 1988**

[30] **Foreign Application Priority Data**

Sep. 16, 1987 [DE] Fed. Rep. of Germany ..... MR588  
[52] **U.S. Cl. .... D26/36**  
[58] **Field of Search .... D26/28, 29, 34, 35, D26/36, 120, 122, 123, 124; 362/61, 72, 74, 80-83.4, 267, 269, 275, 425, 330, 334, 335, 339, 337**

[56] **References Cited**

**U.S. PATENT DOCUMENTS**

D. 224,143	7/1972	Cleminshaw et al. ....	D26/36
D. 228,466	9/1973	Cibie .....	D26/29
D. 237,648	11/1975	Cibie .....	D26/28
D. 248,255	6/1978	Cibie .....	D26/36
D. 260,558	9/1981	Catte .....	D26/29
D. 261,051	9/1981	Catte .....	D26/29
4,506,315	3/1985	Maekawa et al. ....	362/61 X

*Primary Examiner*—Susan J. Lucas  
*Attorney, Agent, or Firm*—Max Fogiel

[57] **CLAIM**

The ornamental design for auxiliary headlamp for motor vehicles, as shown and described.

**DESCRIPTION**

FIG. 1 is a top plan view of an auxiliary headlamp for motor vehicles showing my new design;  
FIG. 2 is a front elevational view thereof;  
FIG. 3 is a left side elevational view thereof;  
FIG. 4 is a rear elevational view thereof;  
FIG. 5 is a right side elevational view thereof;  
FIG. 6 is a bottom plan view thereof.

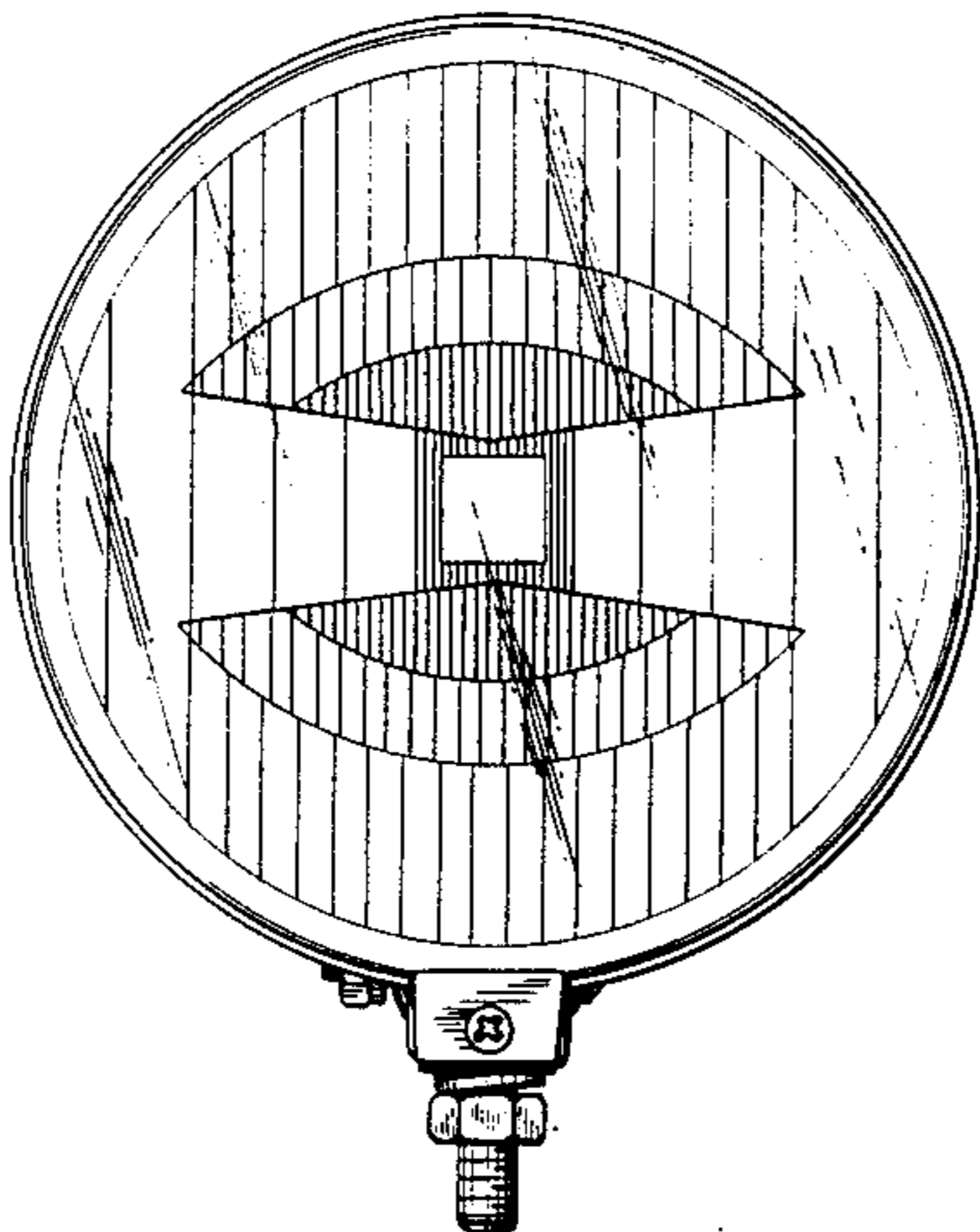
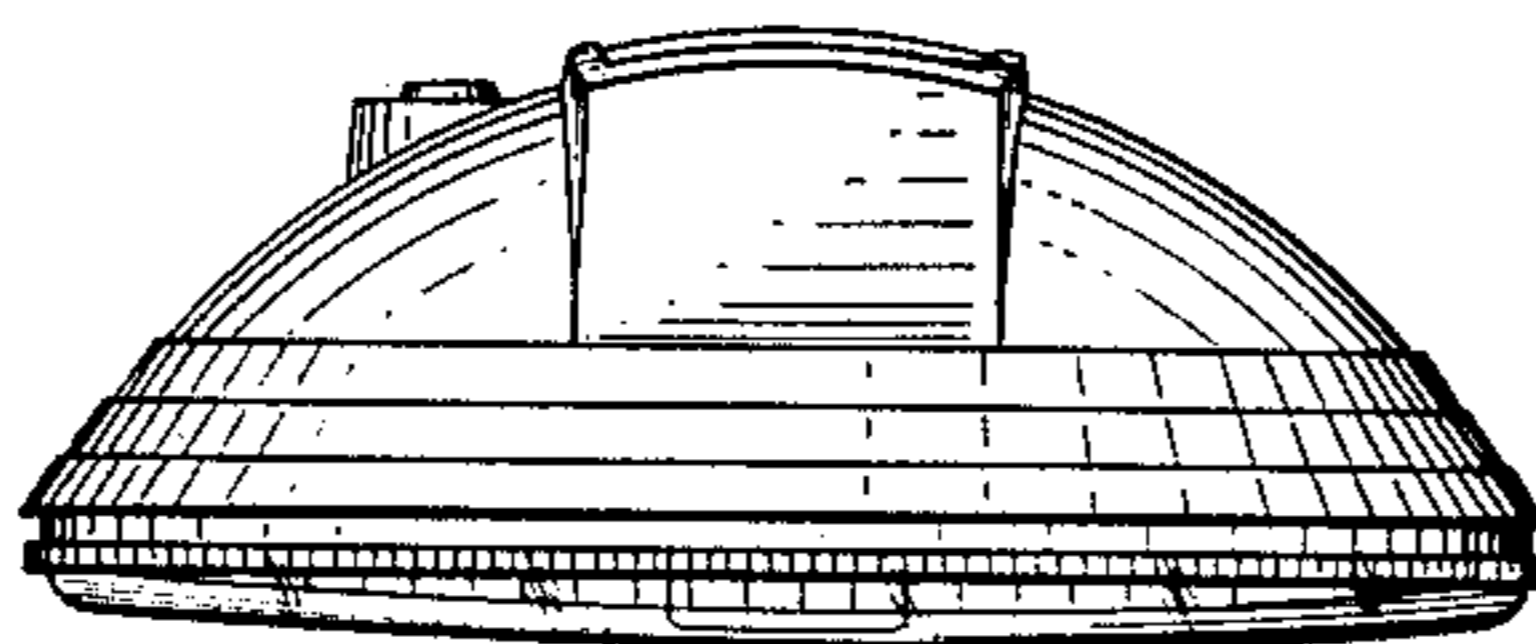

FIG. 1

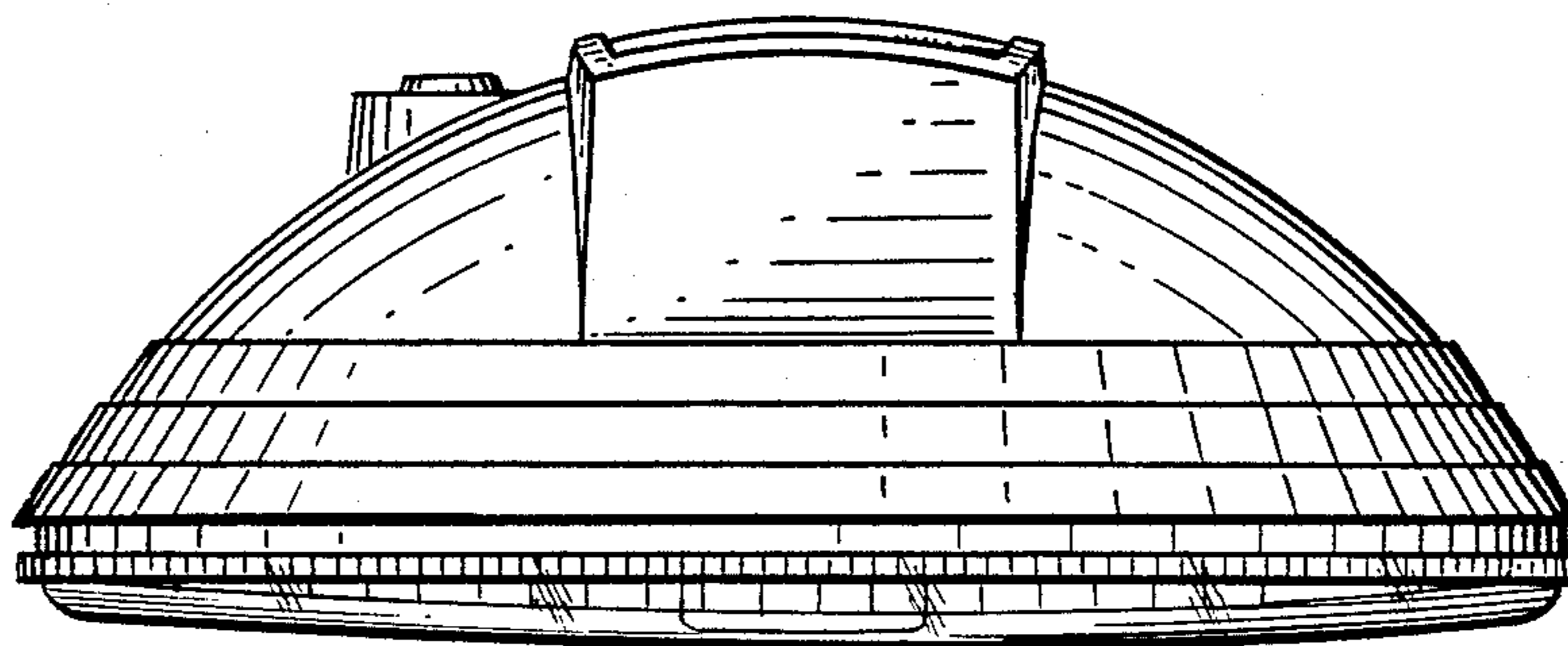
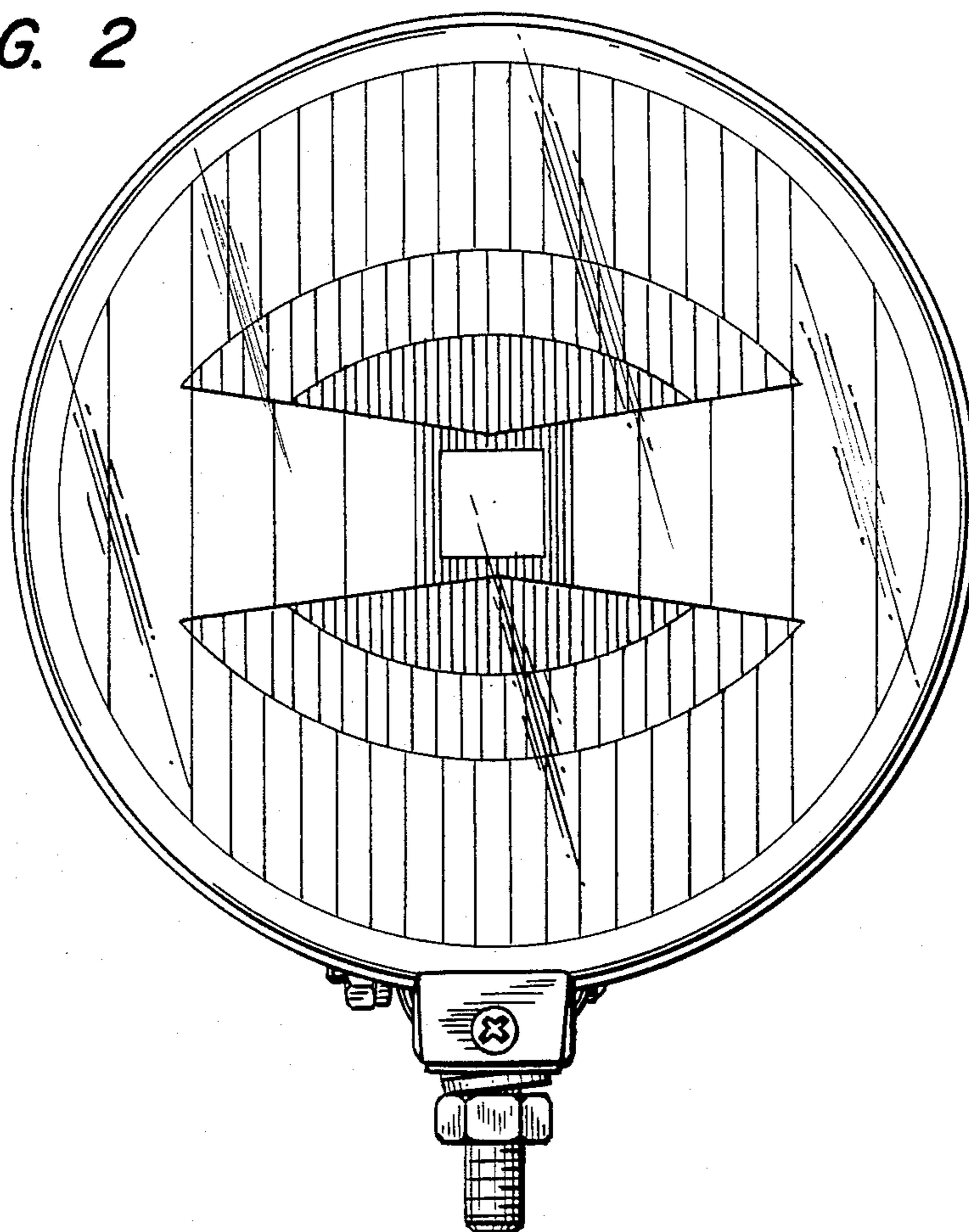

FIG. 2



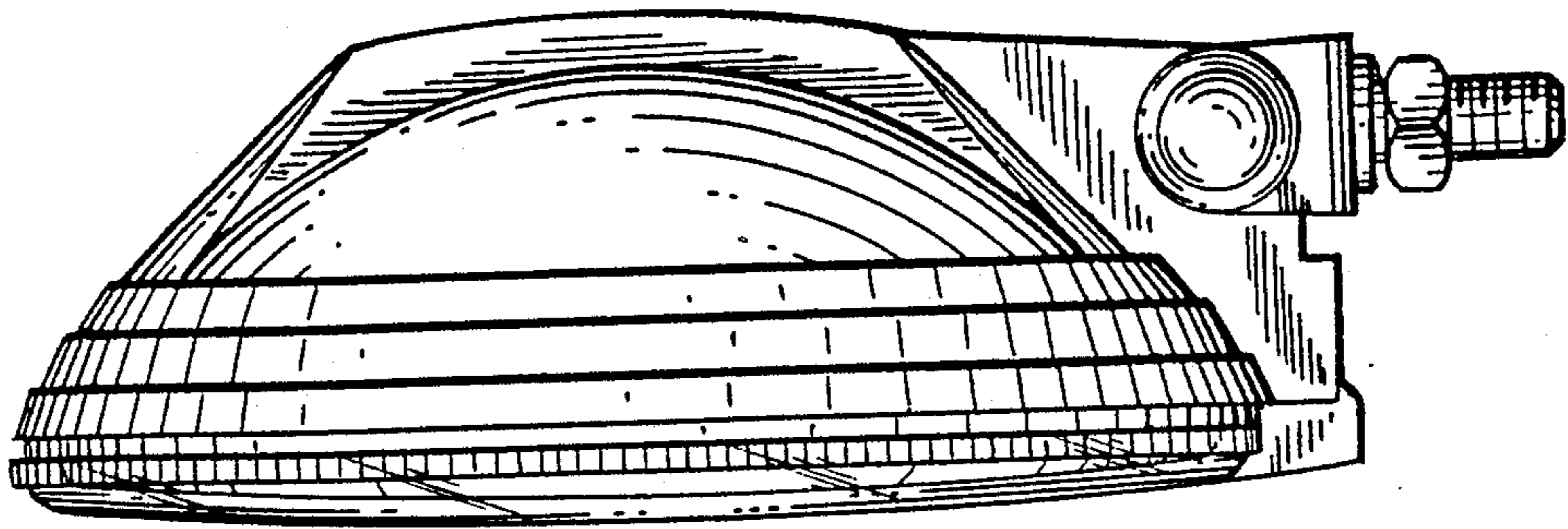

FIG. 5

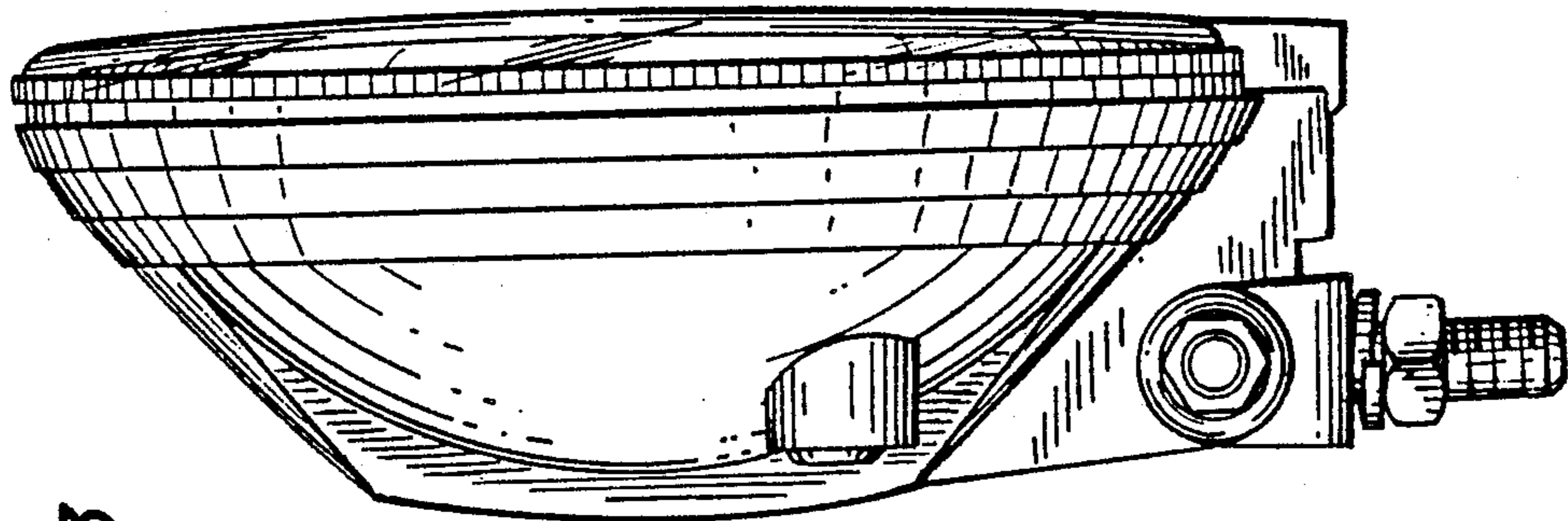
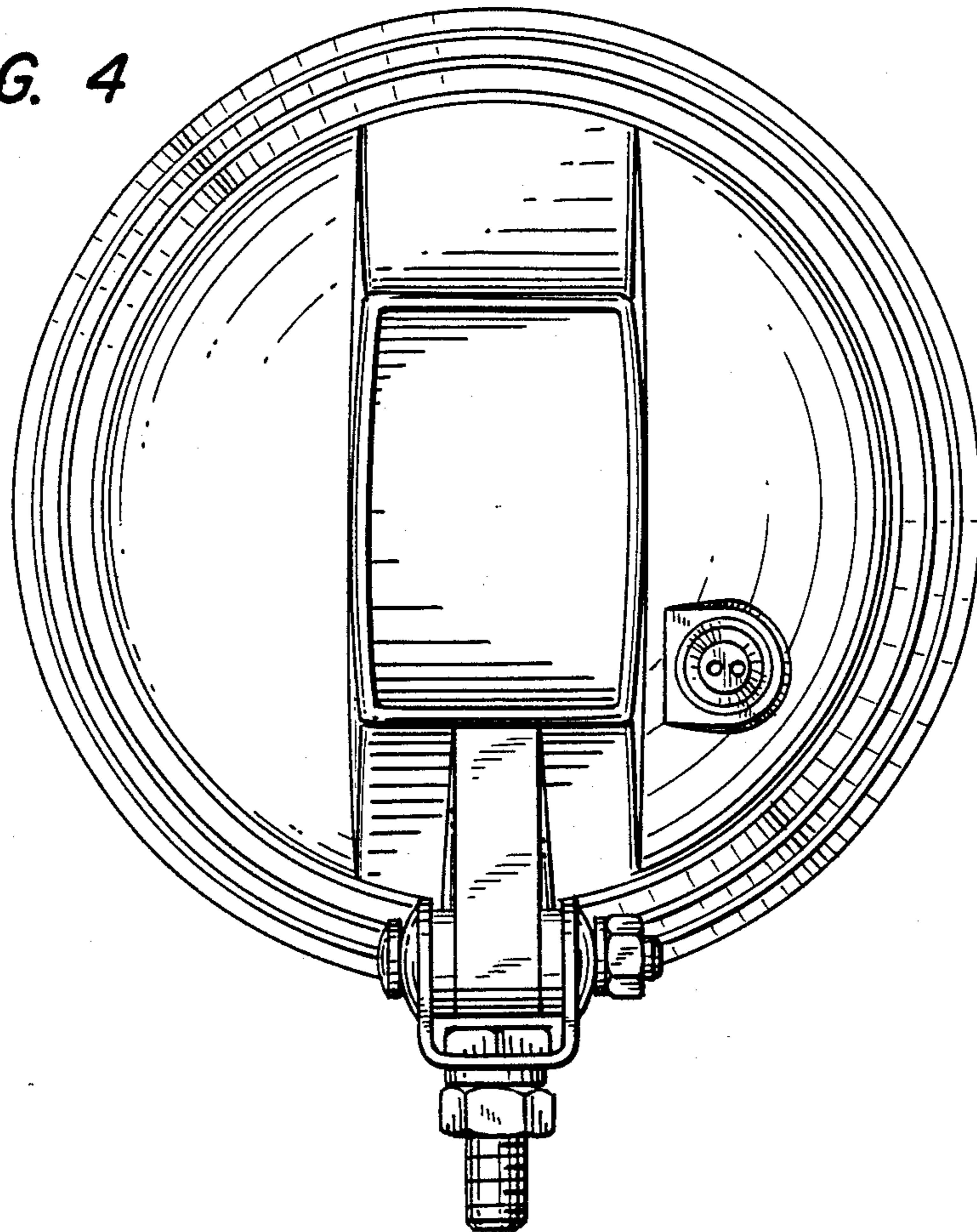

FIG. 3

*FIG. 4*



*FIG. 6*

