

[54] **FACSIMILE TRANSCEIVER**

[75] **Inventors:** Yoshiyuki Fujiyama, Nagano; Sumio Ogawara, Tokyo; Akira Chiku, Nagano; Toshihiro Kumano, Nagano; Yoshitatsu Okiyama, Nagano, all of Japan

[73] **Assignee:** Matsushita Graphic Communication Systems, Inc., Tokyo, Japan

[\*\*] **Term:** 14 Years

[21] **Appl. No.:** 103,976

[22] **Filed:** Oct. 2, 1987

[30] **Foreign Application Priority Data**

Apr. 6, 1987 [JP] Japan ..... 62-13296

[52] **U.S. Cl.** ..... D14/118

[58] **Field of Search** ..... D14/118, 142, 144, 151; D18/36, 37; 358/256, 286

[56] **References Cited**

**U.S. PATENT DOCUMENTS**

- D. 299,494 1/1989 Tsuruoka ..... D14/118
- D. 300,137 3/1989 Kando ..... D14/118
- D. 300,139 3/1989 Nishio ..... D14/118

**OTHER PUBLICATIONS**

HFD, 6/15/87, p. 76, Bottom center—The FaxLine.  
 HFD, 9/28/87, p. 75, Bottom left—UX-30 Memo Fax.  
 The Office, Sep. 1987, p. 148, Right—Facsimile System.  
 Toshiba Catalog Spot, Oct. 1986.  
 National Catalog Panafax UF5, Nov. 1986.  
 Copy of Japanese Design Reg. No. 578873 published Jun. 12, 1982 by Nippon Telegraph & Telephone Public Corporation and NEC Corporation, entitled "Facsimile Transceiver with Telephone".

*Primary Examiner*—Bernard Ansher  
*Assistant Examiner*—Theodore M. Shooman  
*Attorney, Agent, or Firm*—Sughrue, Mion, Zinn, Macpeak & Seas

[57] **CLAIM**

The ornamental design for a facsimile transceiver, as shown.

**DESCRIPTION**

FIG. 1 is a front, top and right side perspective view of a facsimile transceiver showing our new design;  
 FIG. 2 is a rear, top and left side perspective view thereof;  
 FIG. 3 is a front elevational view thereof;  
 FIG. 4 is a rear elevational view thereof;  
 FIG. 5 is a top plan view thereof;  
 FIG. 6 is a bottom plan view thereof;  
 FIG. 7 is a left side elevational view thereof; and  
 FIG. 8 is a right side elevational view thereof.

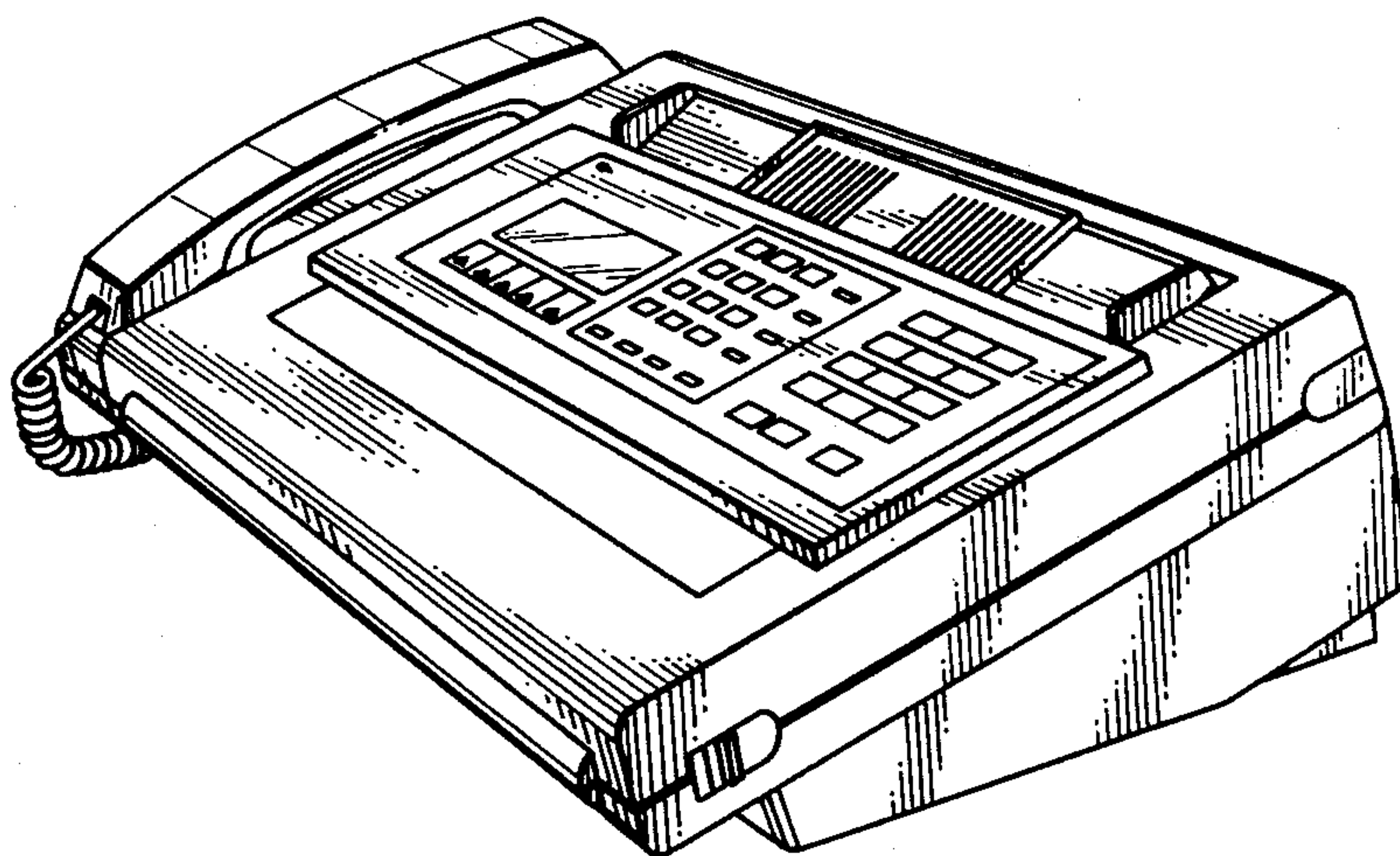

*Fig. 1*

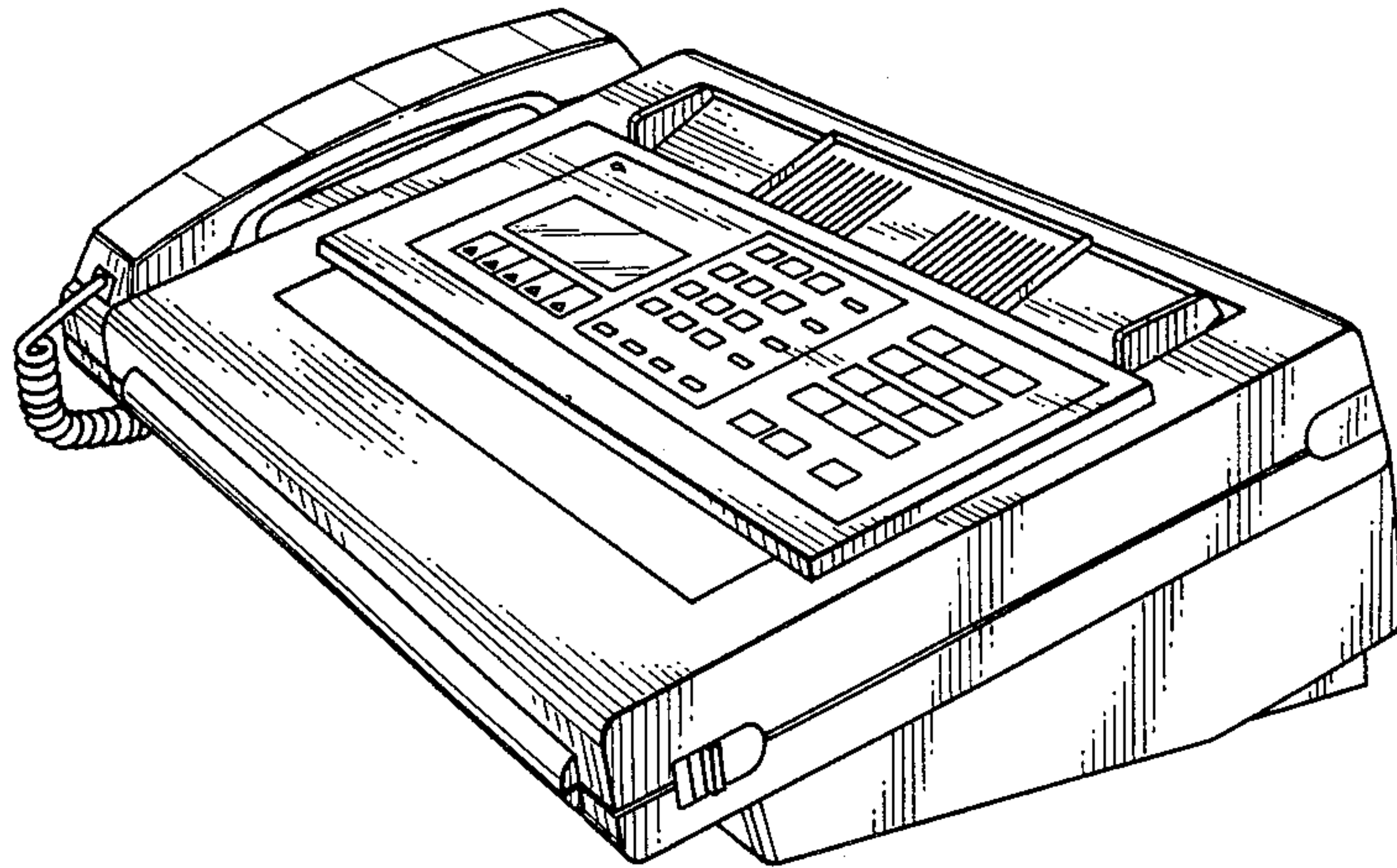

*Fig. 2*

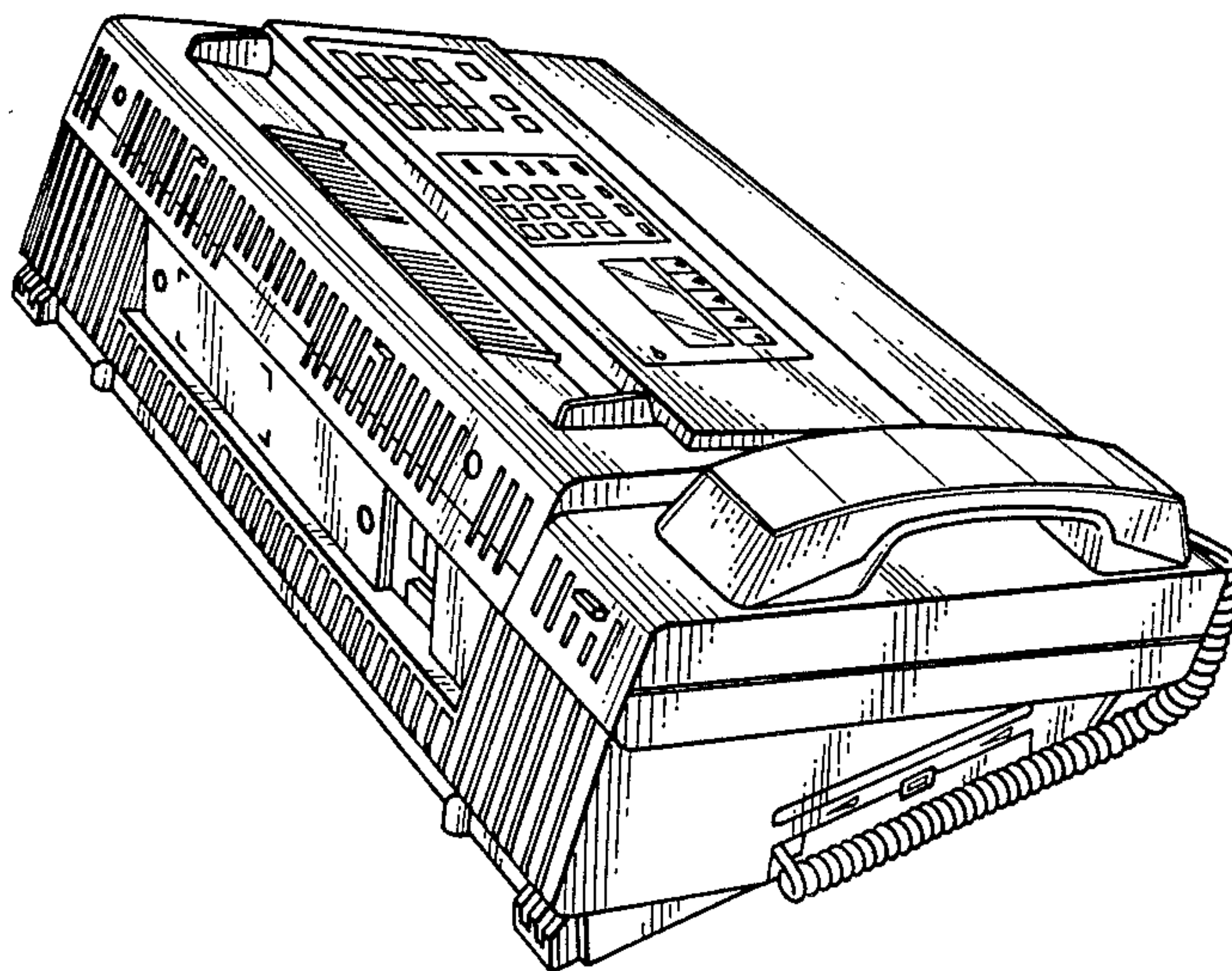

Fig. 3

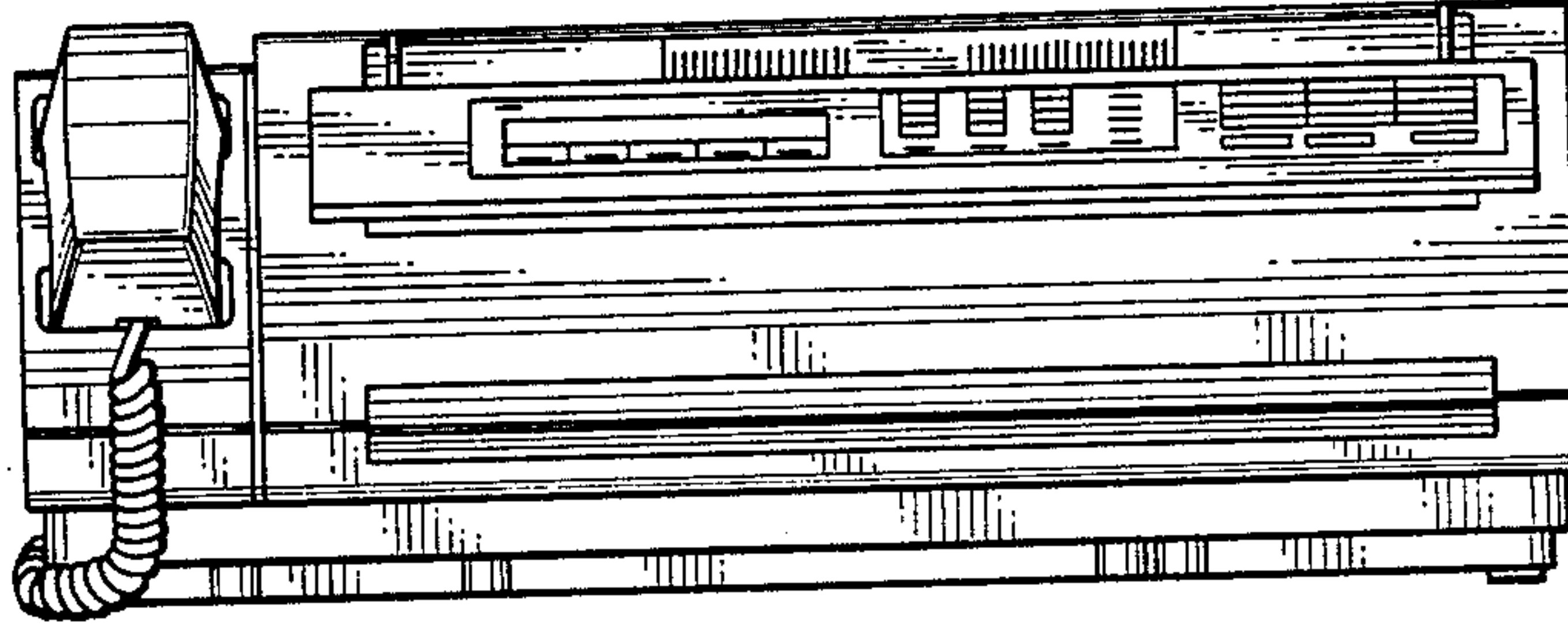

Fig. 4

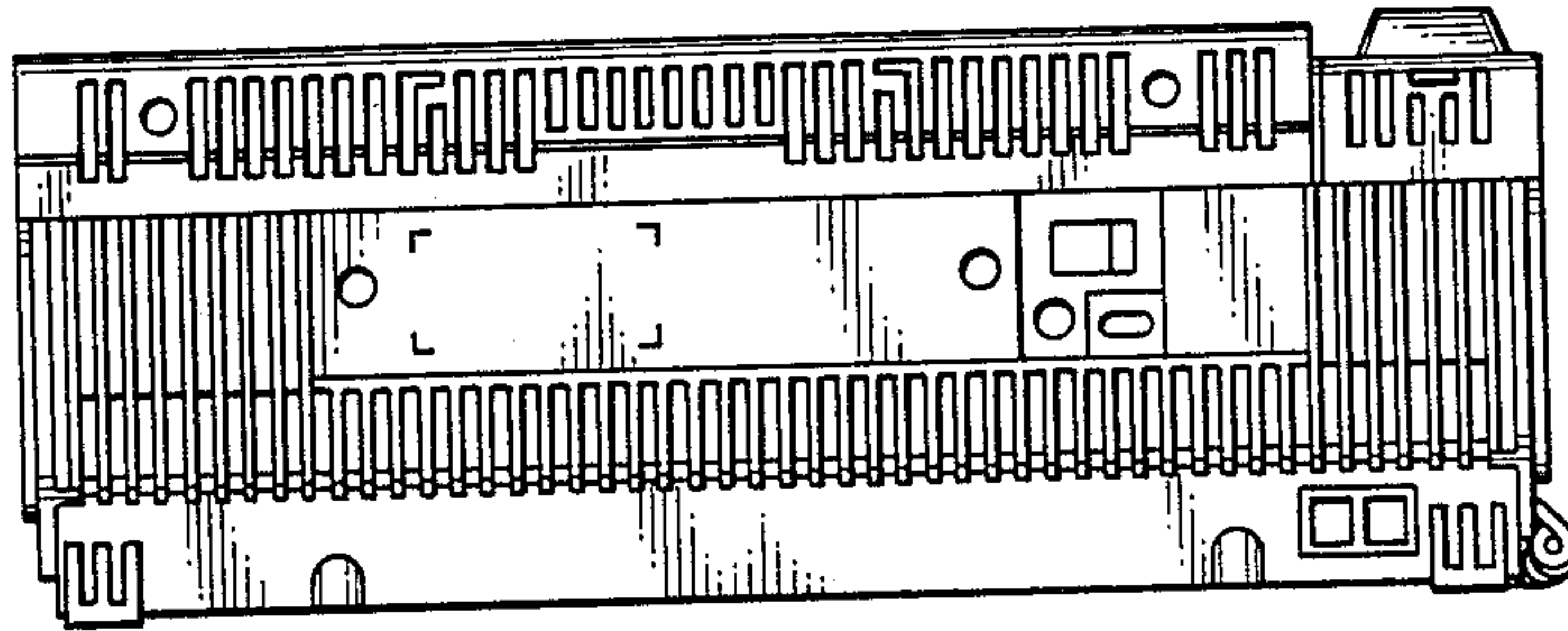



Fig. 5

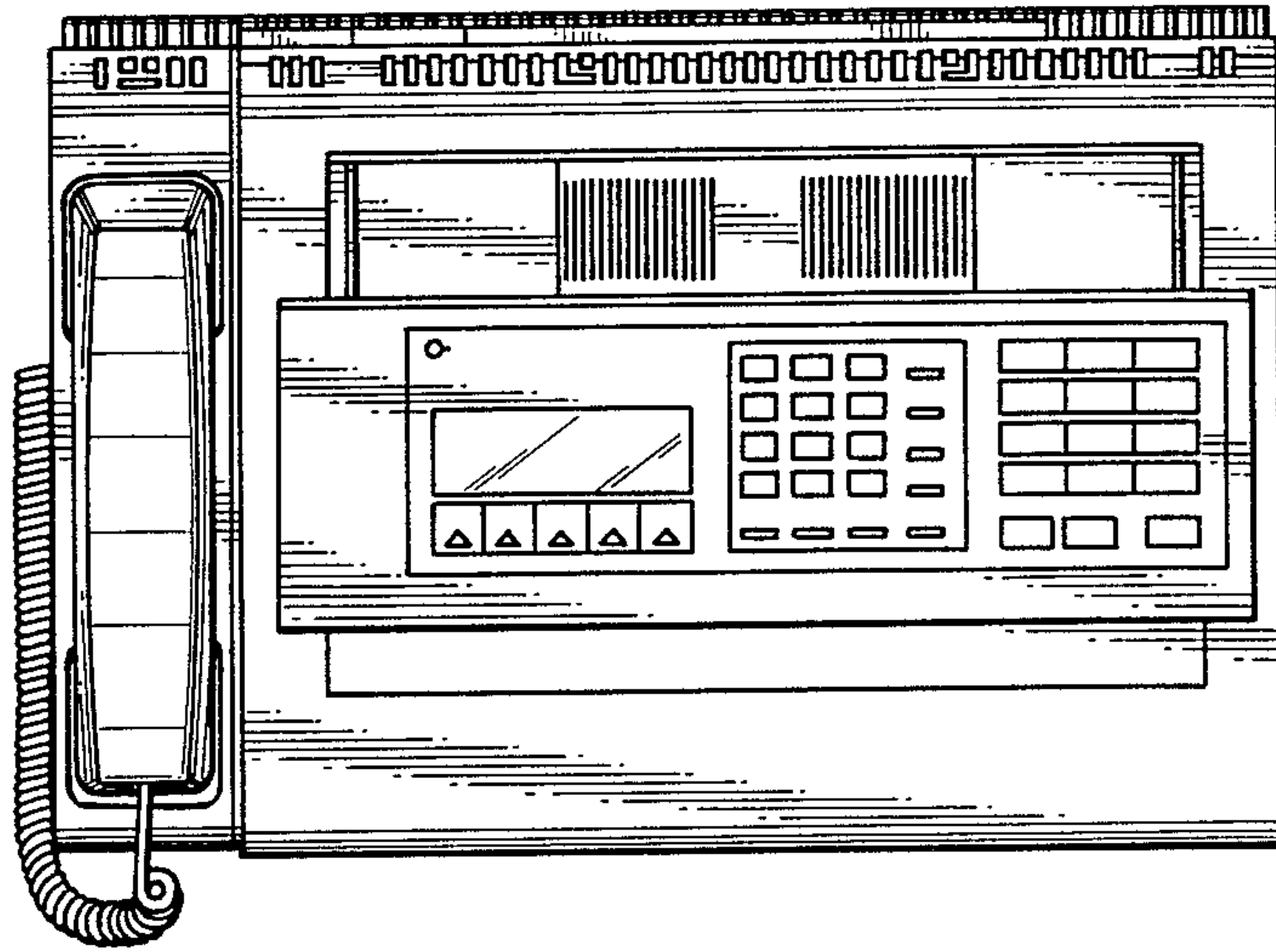
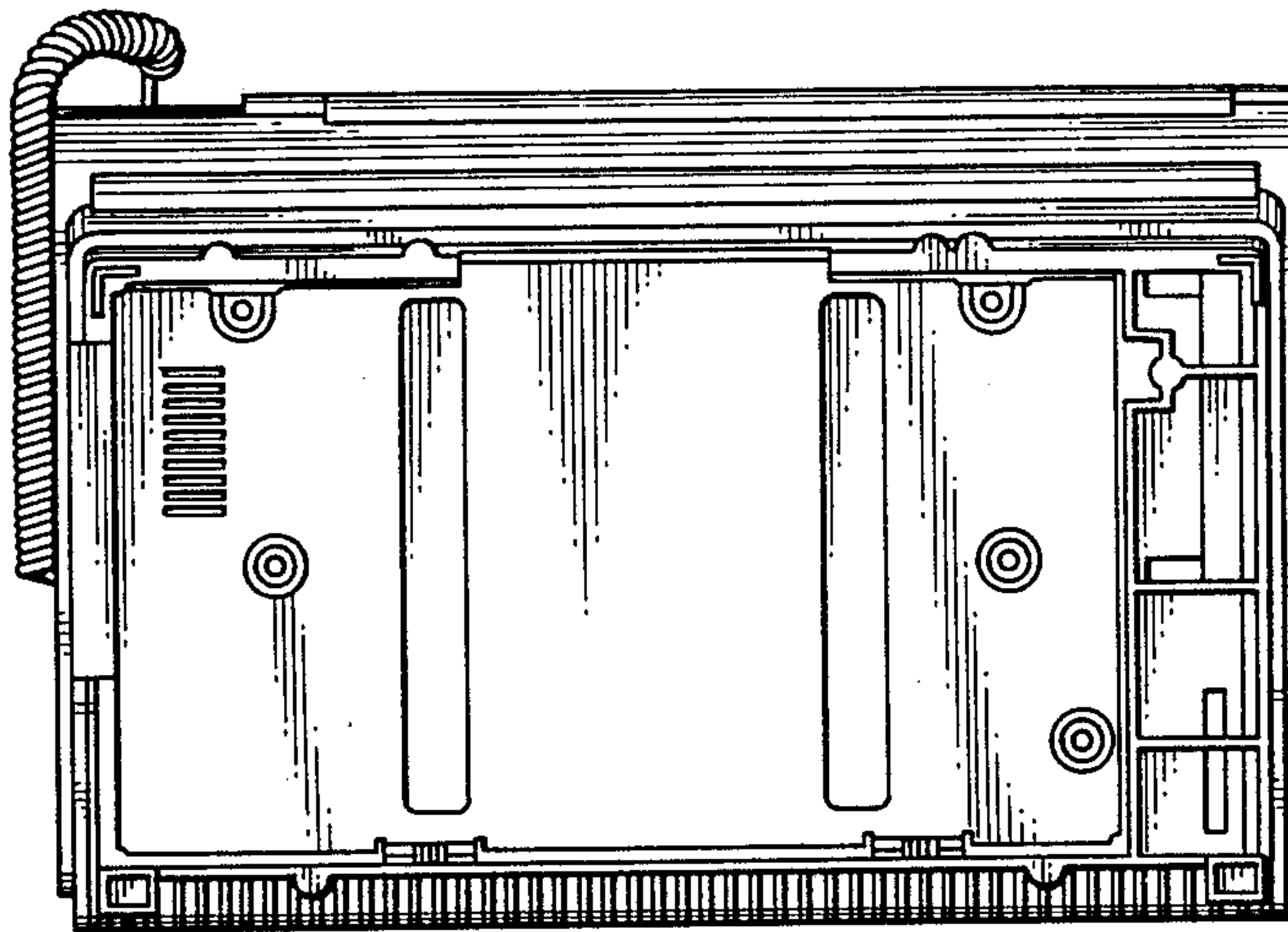
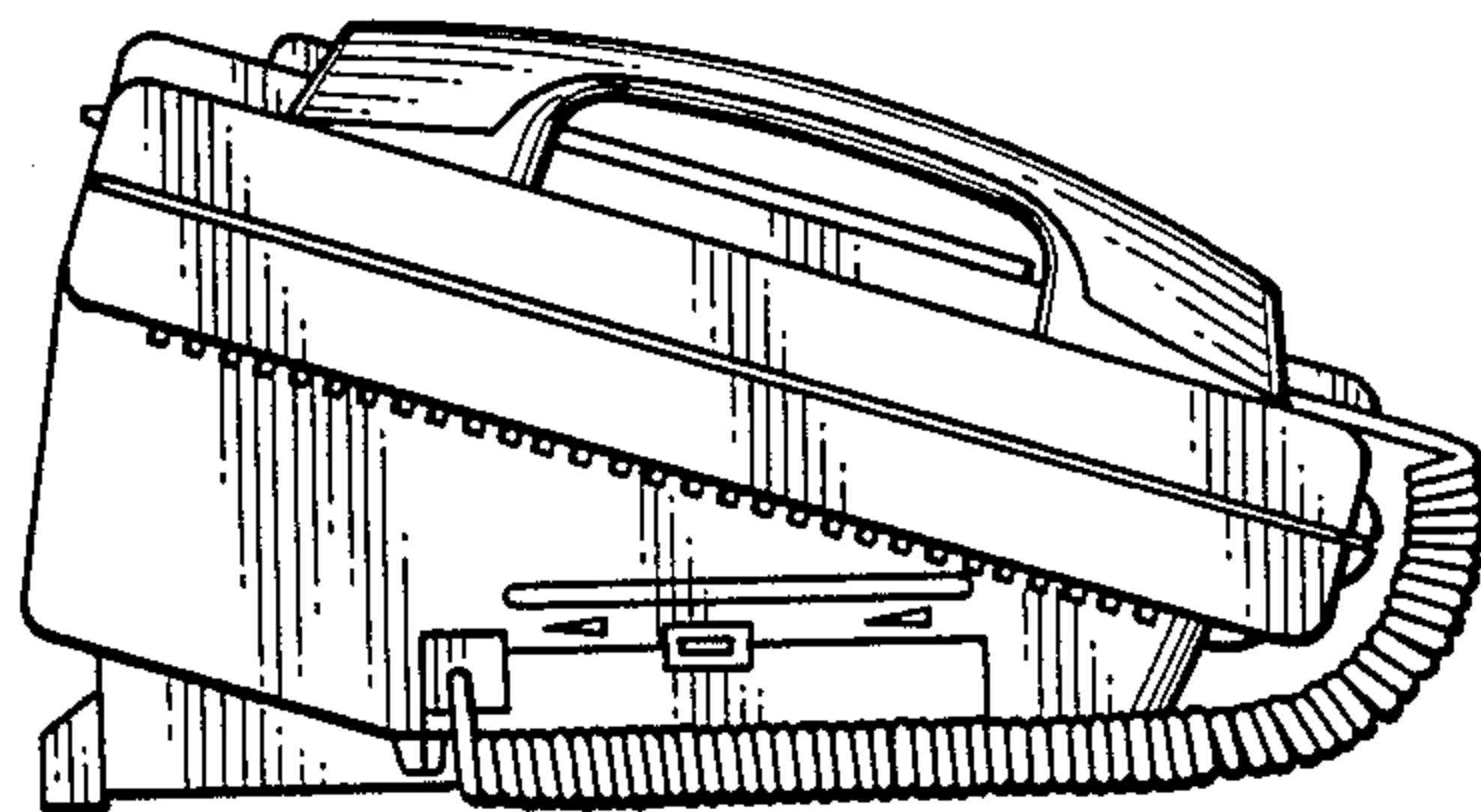

Fig. 6



*Fig. 7*



*Fig. 8*

