

[54] **GARMENT RACK**

[75] **Inventors:** Milton E. Handler, Northbrook;  
 Richard Sylvan, Glenview; Herbert  
 Baisch, Palatine, all of Ill.

[73] **Assignee:** Hirsh Company, Skokie, Ill.

[\*\*] **Term:** 14 Years

[21] **Appl. No.:** 2,303

[22] **Filed:** Jan. 9, 1987

[52] **U.S. Cl. ....** D6/411

[58] **Field of Search ....** D6/411, 412, 413, 414,  
 D6/415; 211/204, 208

[56] **References Cited**

**U.S. PATENT DOCUMENTS**

D. 167,461	8/1952	Hefel .....	D6/414
D. 211,432	6/1968	Gelles .....	D6/411
2,893,568	7/1959	Scholz .....	211/204
3,146,892	9/1964	White .....	211/204
3,197,035	7/1965	Wolf .....	211/204
3,246,768	4/1966	Carlos .....	211/204

**OTHER PUBLICATIONS**

*Racks* by L. A. Darling Co. cat. #515, p. 18, Umbrella & Rainwear Rack #R29 top right on page.

*Primary Examiner*—Carmen H. Vales-Lado  
*Attorney, Agent, or Firm*—Dressler, Goldsmith, Shore,  
 Sutker & Milnamow, Ltd.

[57] **CLAIM**

The ornamental design for a garment rack, as shown and described.

**DESCRIPTION**

FIG. 1 is a perspective view of a garment rack showing our new design;  
 FIG. 2 is a top plan view thereof;  
 FIG. 3 is a left side elevational view, the right side being identical thereto;  
 FIG. 4 is a front elevational view, the rear being identical thereto;  
 FIG. 5 is a perspective view of a second embodiment of a garment rack showing our new design;  
 FIG. 6 is a top plan view thereof;  
 FIG. 7 is a left side elevational view, the right side being identical thereto; and  
 FIG. 8 is a front elevational view, the rear being identical thereto.

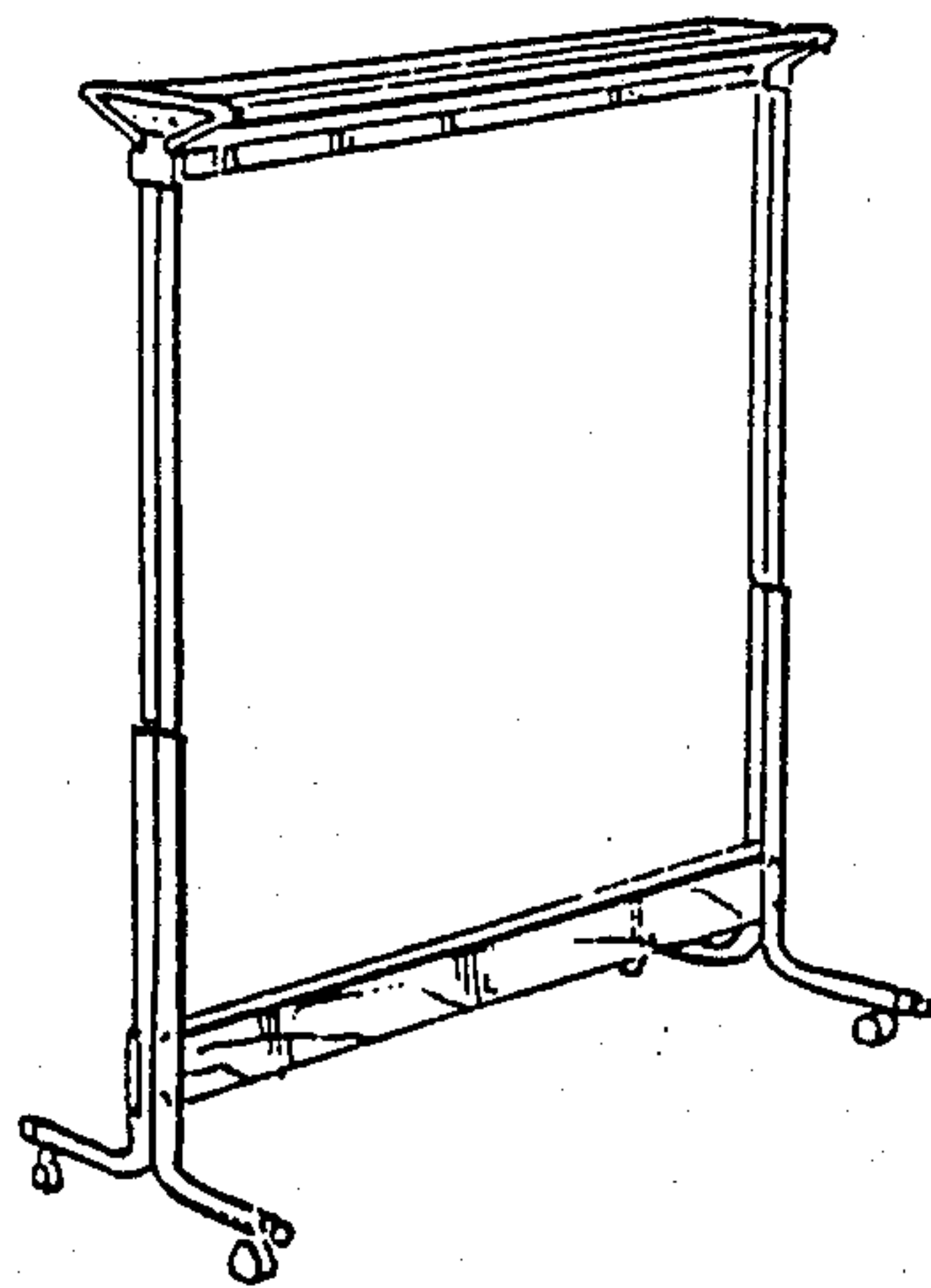
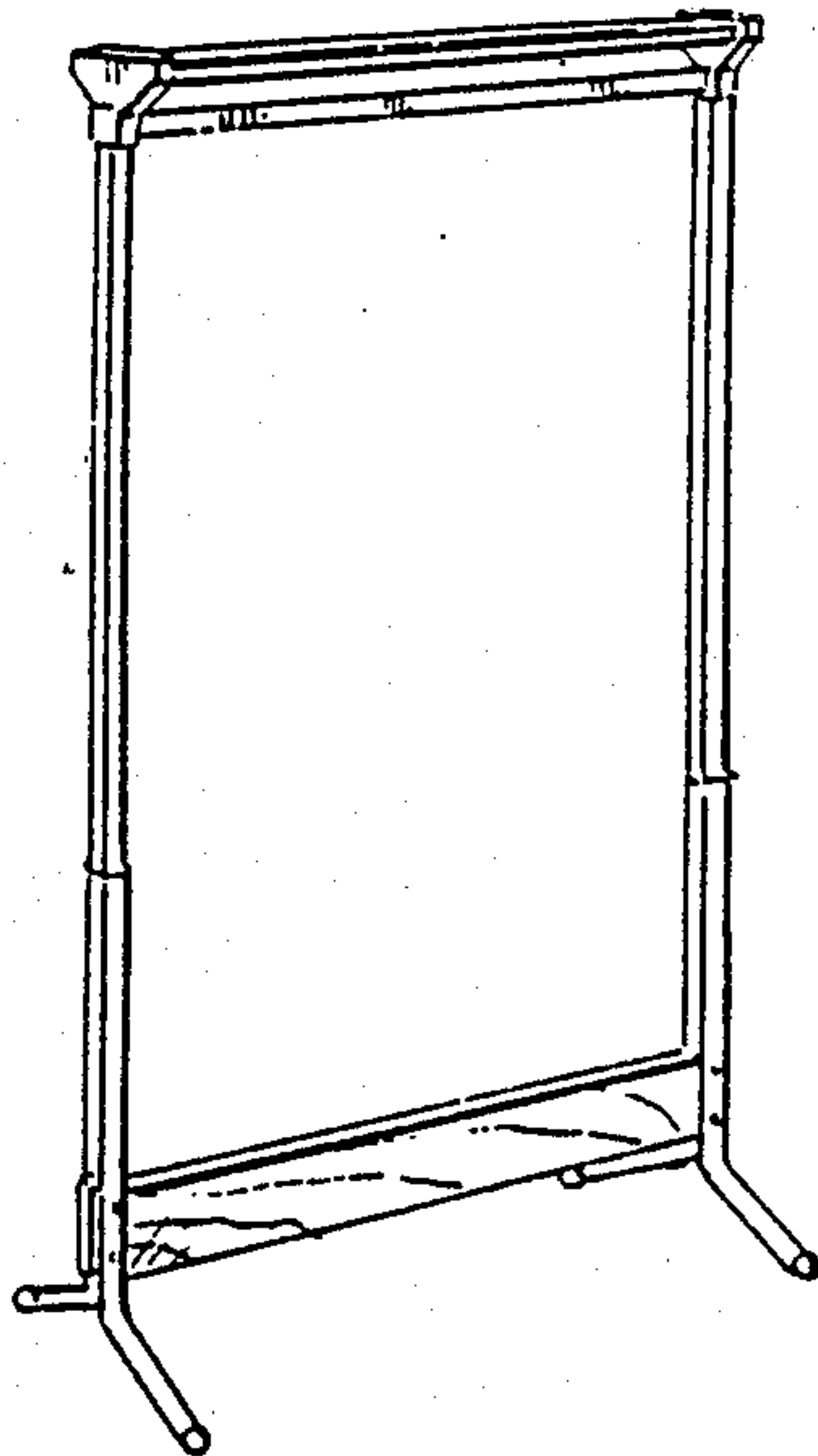

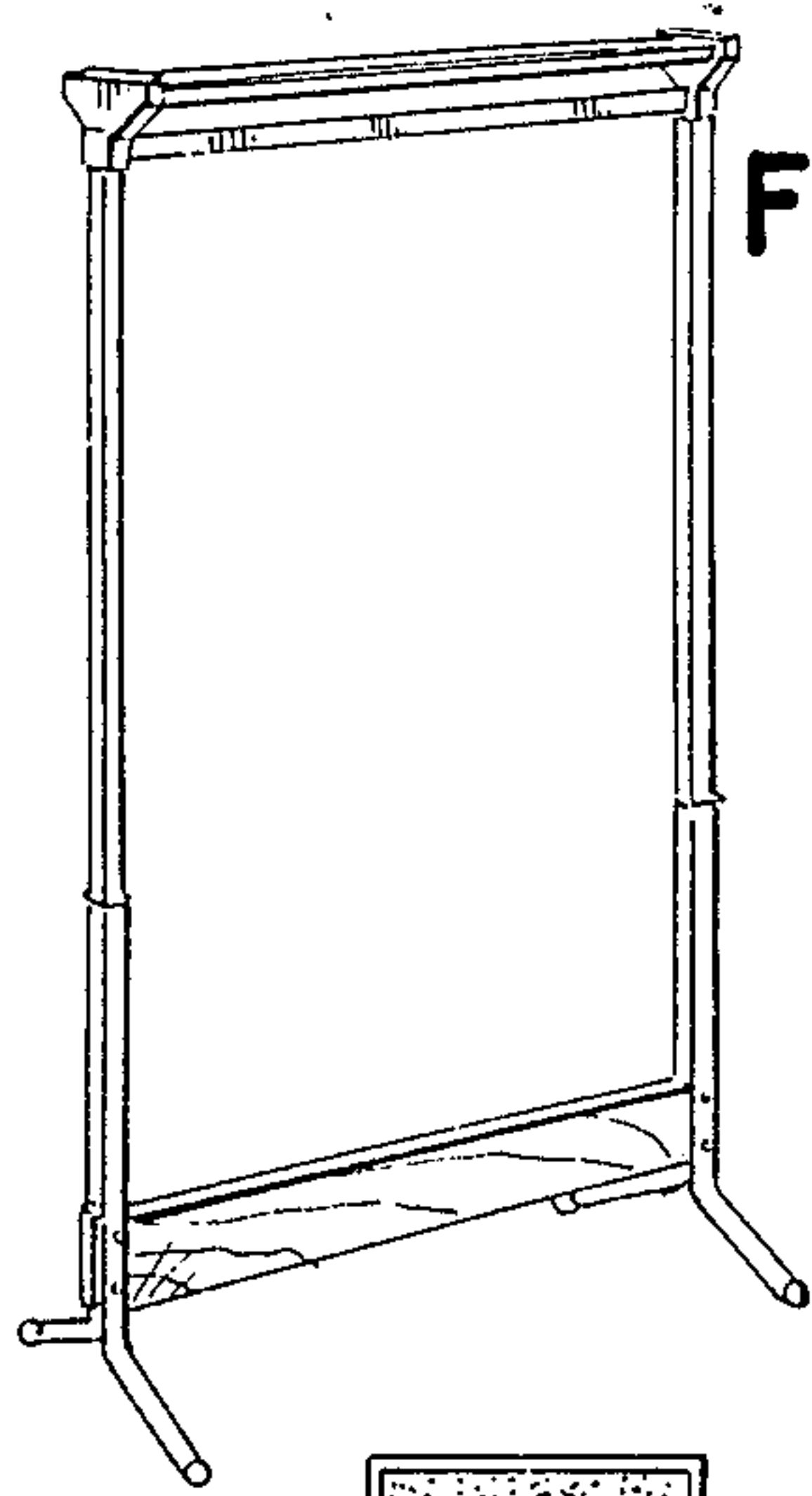

FIG. 1

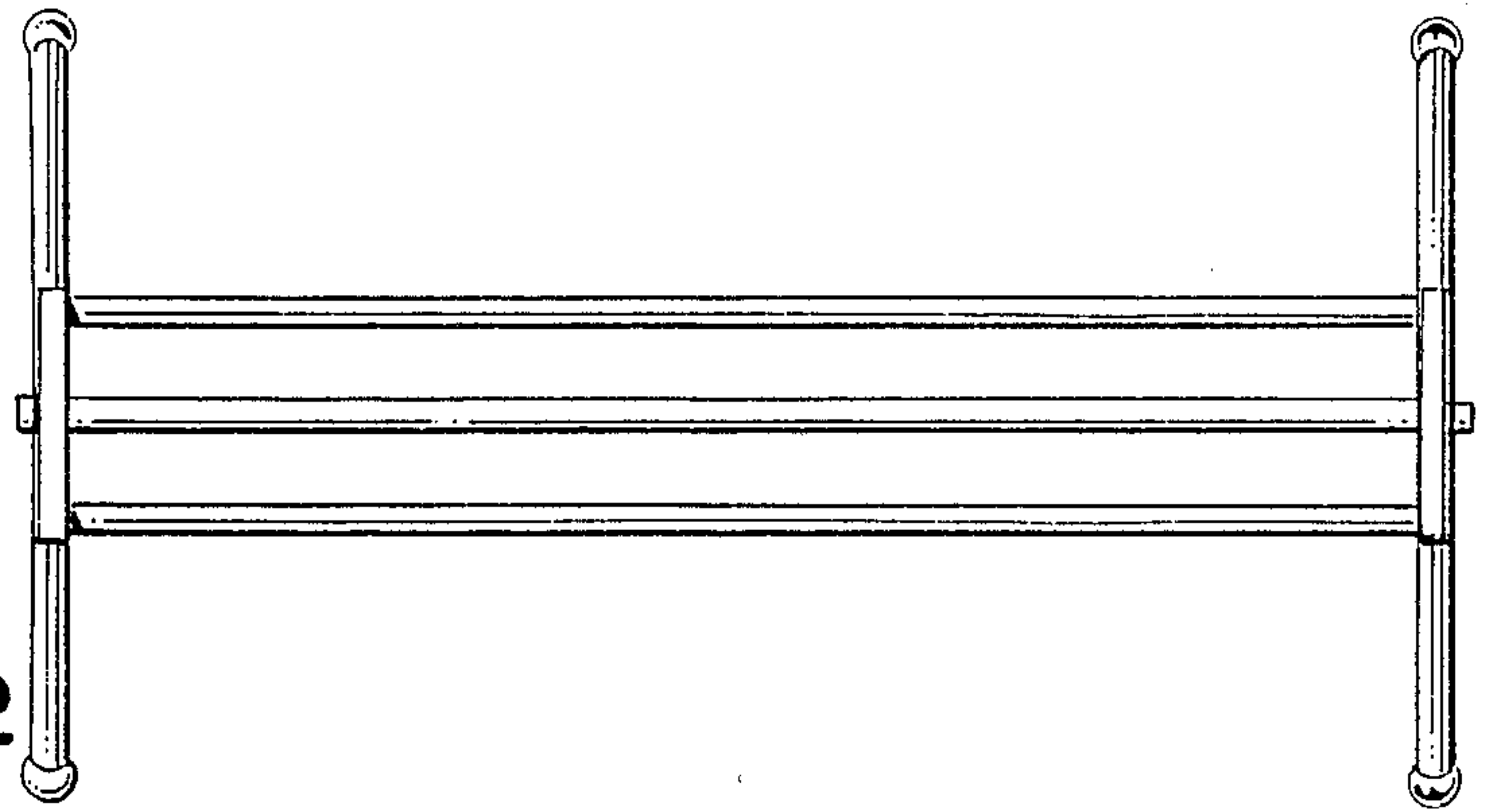

FIG. 2

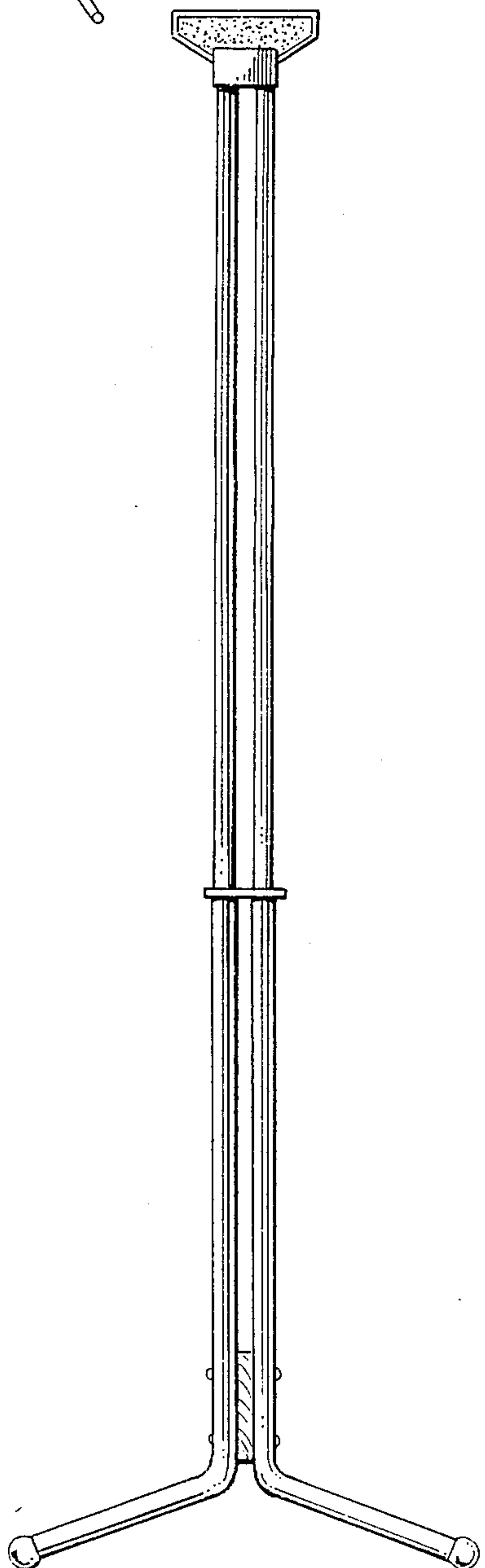

FIG. 3

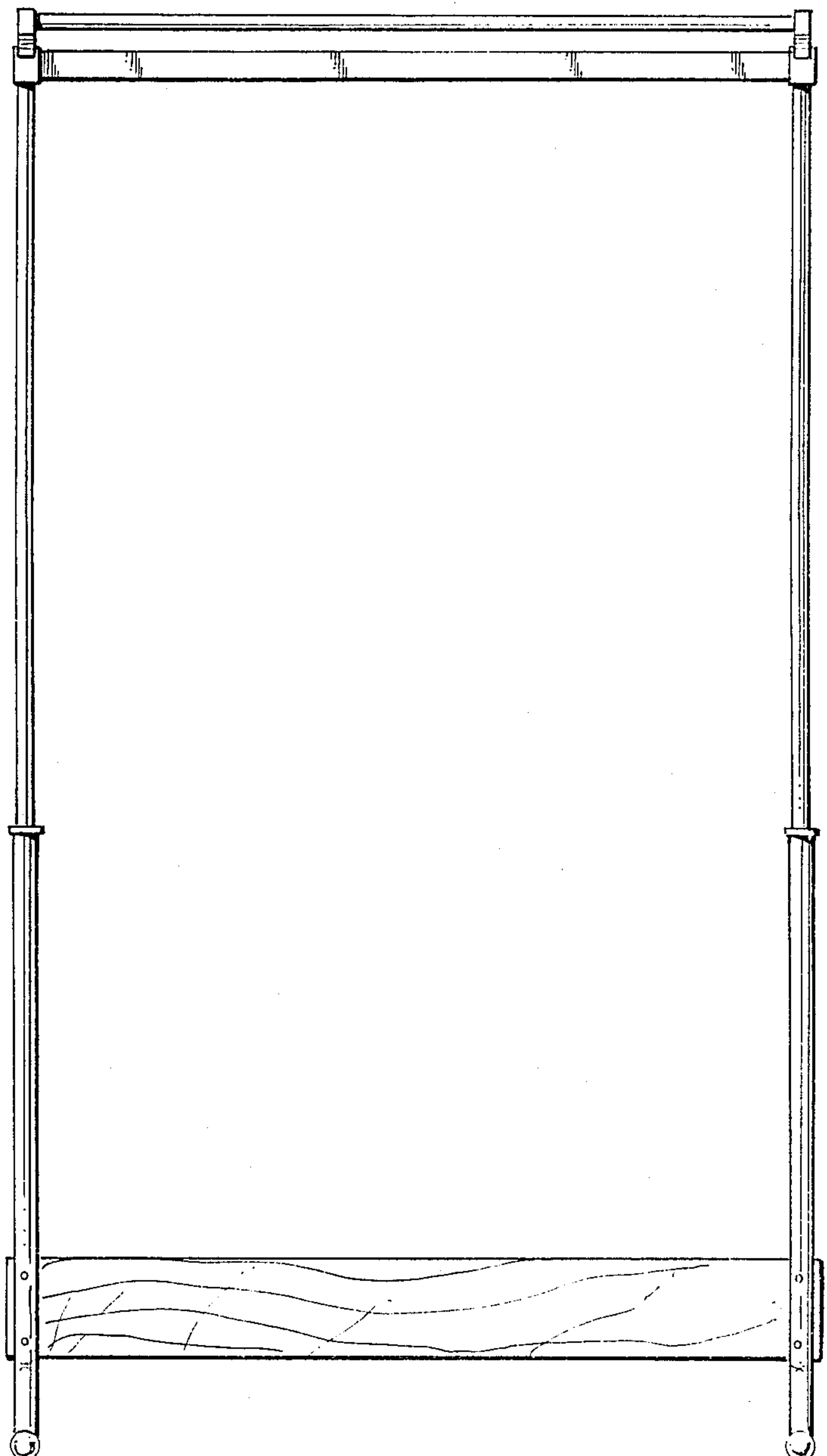

FIG. 4

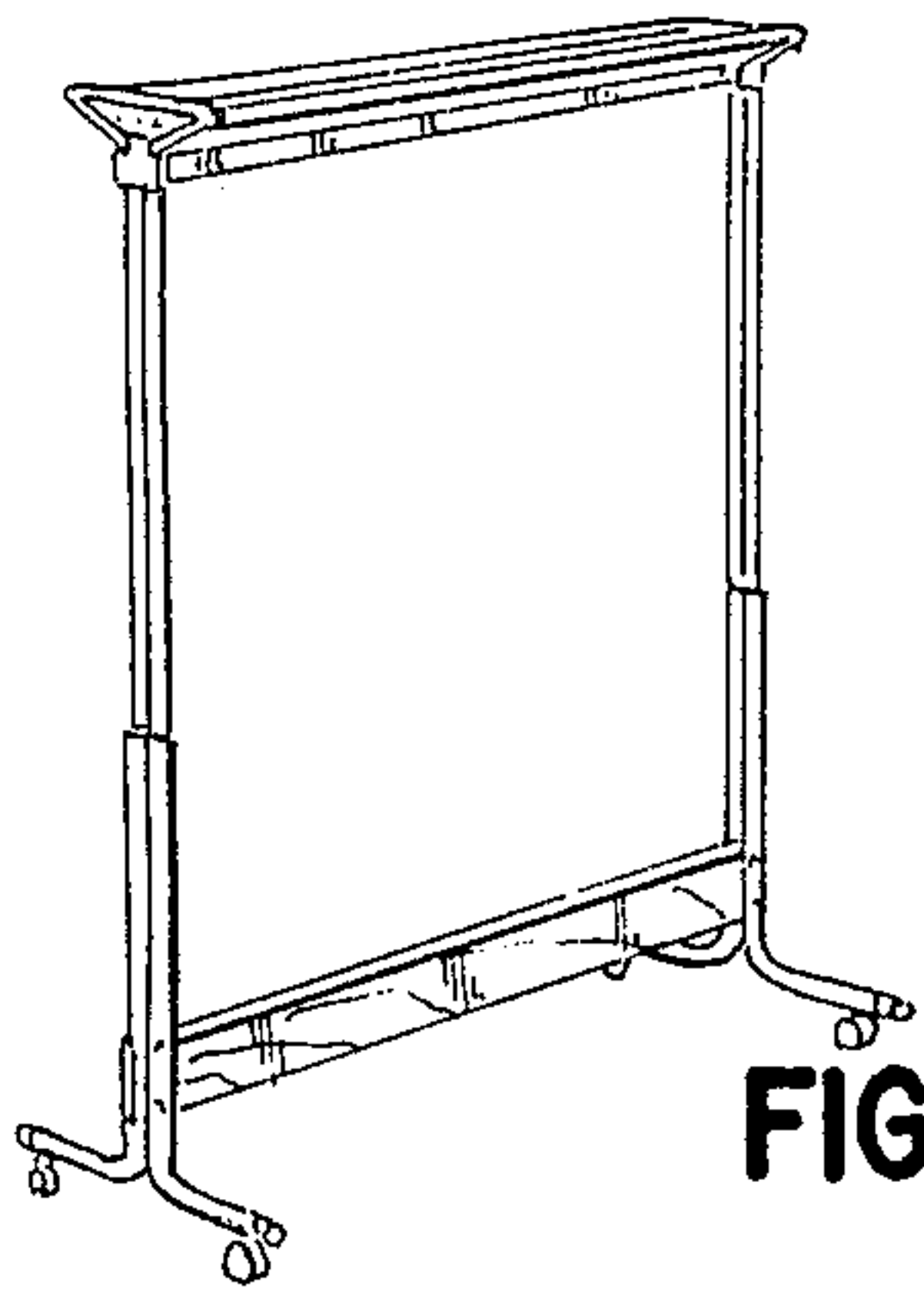

FIG. 5

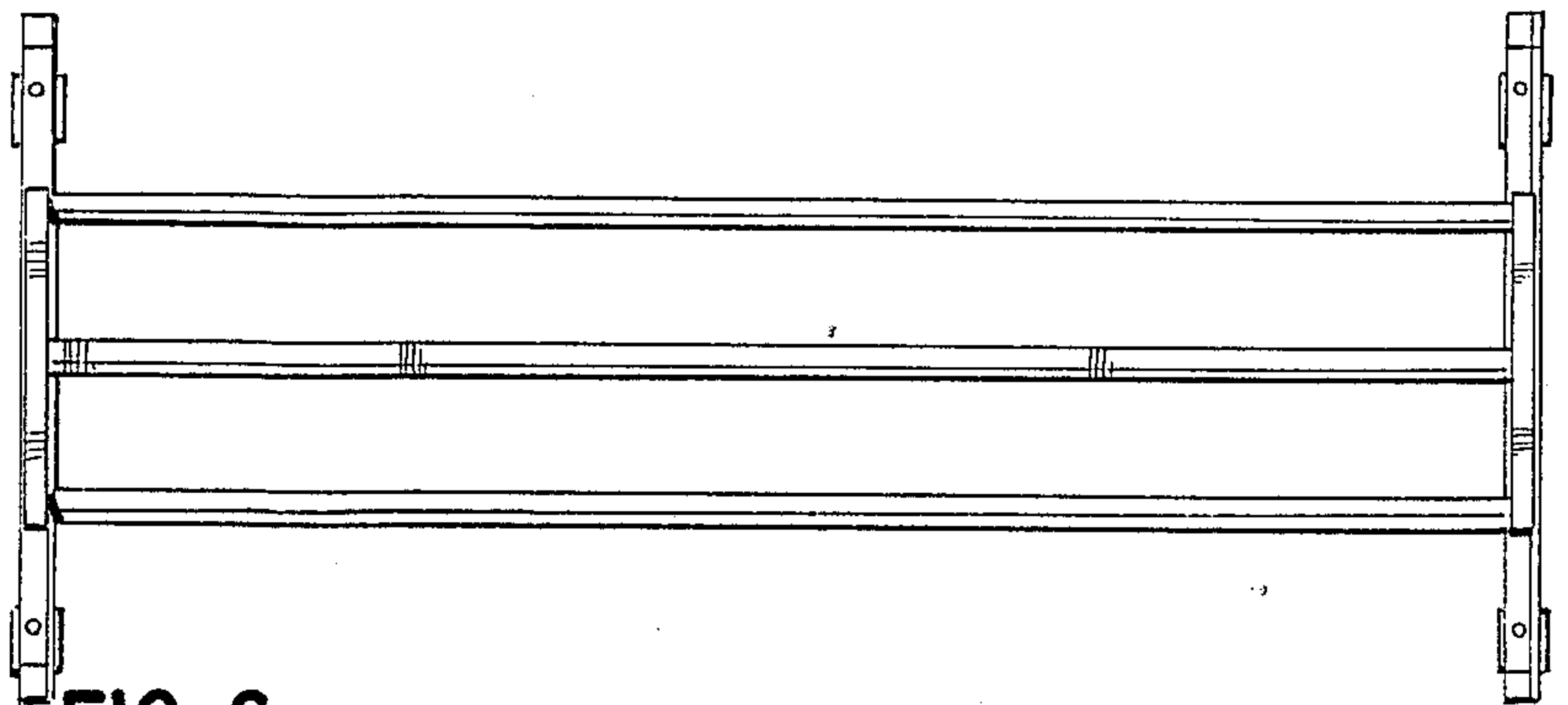

FIG. 6

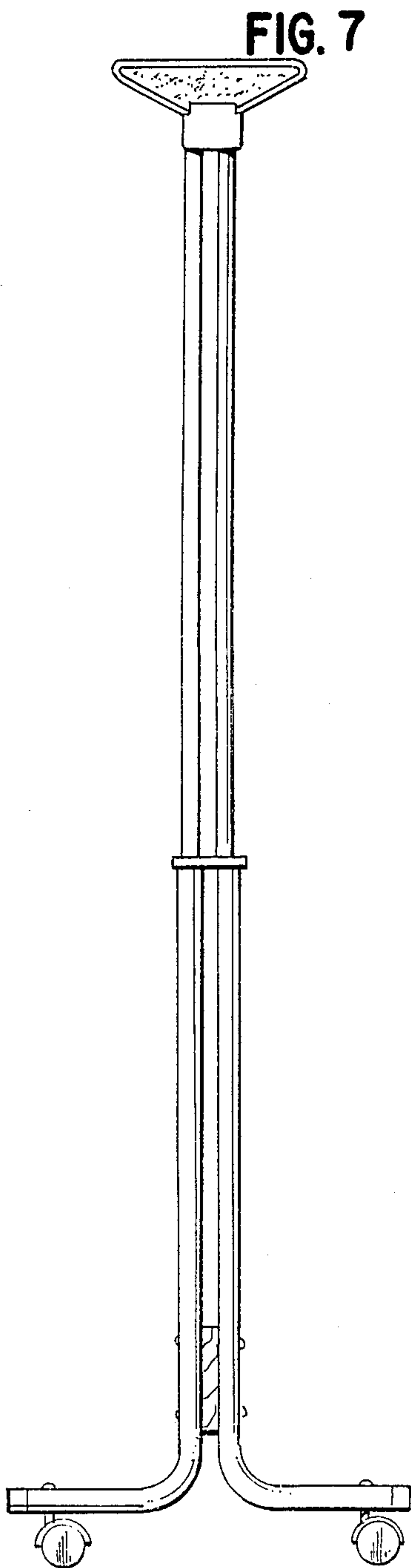

FIG. 7

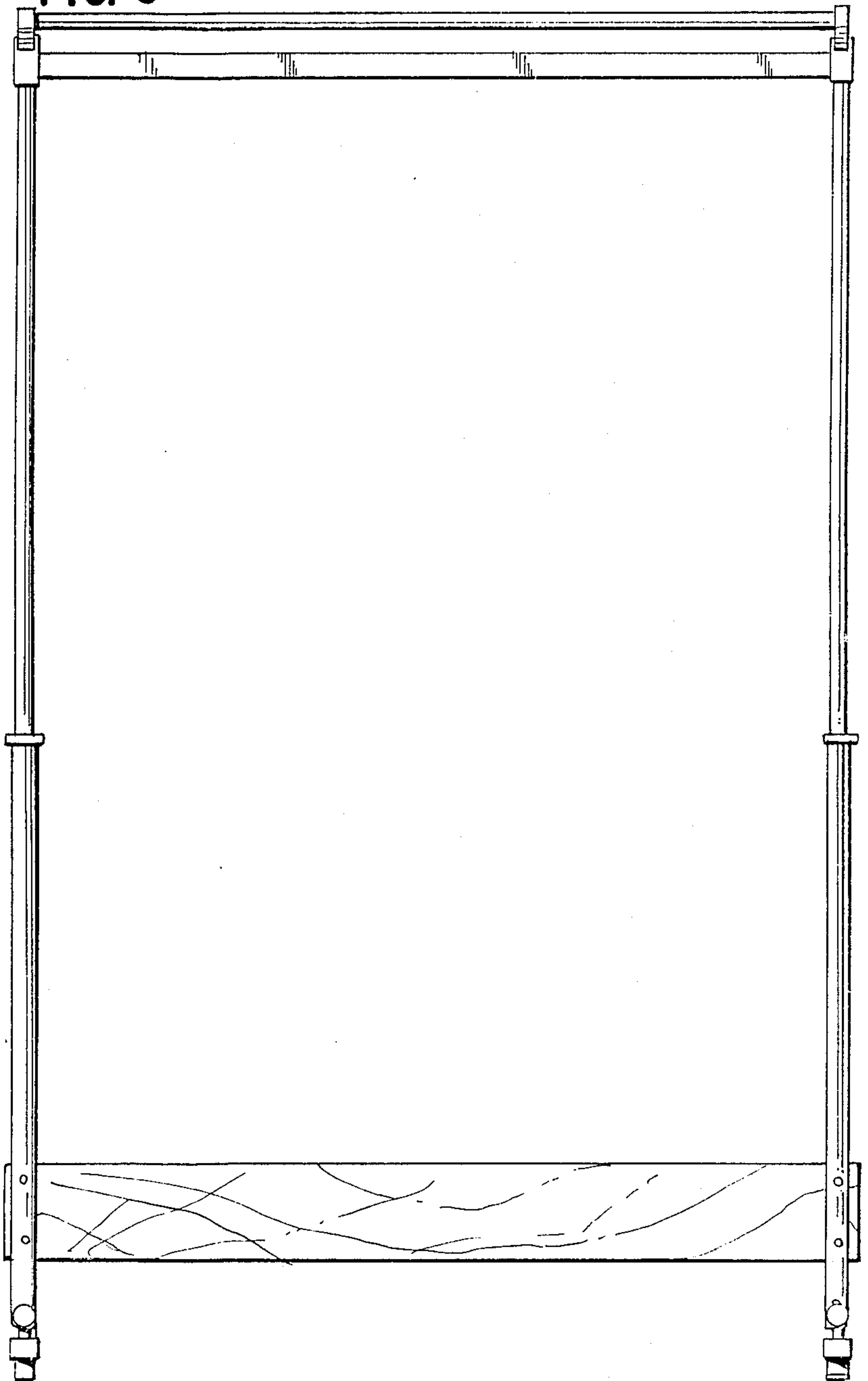

FIG. 8