

# United States Patent [19]

Rogers et al.

[11] Patent Number: Des. 304,499

[45] Date of Patent: \*\* Nov. 7, 1989

[54] FOLDING STAIR UNIT

[75] Inventors: Orley D. Rogers, Farwell; Kenneth E. Staten, Clare, both of Mich.

[73] Assignee: Stageright Corporation, Clare, Mich.

[\*\*] Term: 14 Years

[21] Appl. No.: 194,572

[22] Filed: May 12, 1988

[52] U.S. Cl. .... D25/62

[58] Field of Search ..... D25/62, 63, 65, 66, D25/68, 69; 52/690, 694, 8, 9; 182/113, 152, 159

[56] References Cited

U.S. PATENT DOCUMENTS

D. 179,311	11/1956	Marcy	.....	D25/65
D. 229,921	1/1974	De Luca	.....	D25/66
3,207,260	9/1965	Castagna	.....	182/152
3,747,708	7/1973	Wenger et al.	.....	52/9
4,006,564	2/1977	Wiese	.....	52/9

4,276,955	7/1981	Hickman	.....	182/129
4,412,403	11/1983	Le Franc et al.	.....	52/9

Primary Examiner—Wallace R. Burke  
Assistant Examiner—Doris Clark  
Attorney, Agent, or Firm—Barnes, Kisselle, Raisch, Choate, Whittemore & Hulbert

[57] CLAIM

The ornamental design for a folding stair unit, as shown.

DESCRIPTION

FIG. 1 is a left side elevational view of a folding stair unit showing my new design;  
FIG. 2 is a front elevational view thereof;  
FIG. 3 is a right side elevational view thereof;  
FIG. 4 is a rear elevational view thereof;  
FIG. 5 is a top plan view thereof;  
FIG. 6 is a bottom plan view thereof;  
FIG. 7 is a right side elevational view with the step element partially closed; and,  
FIG. 8 is a right side elevational view with the step element fully closed to storage position.

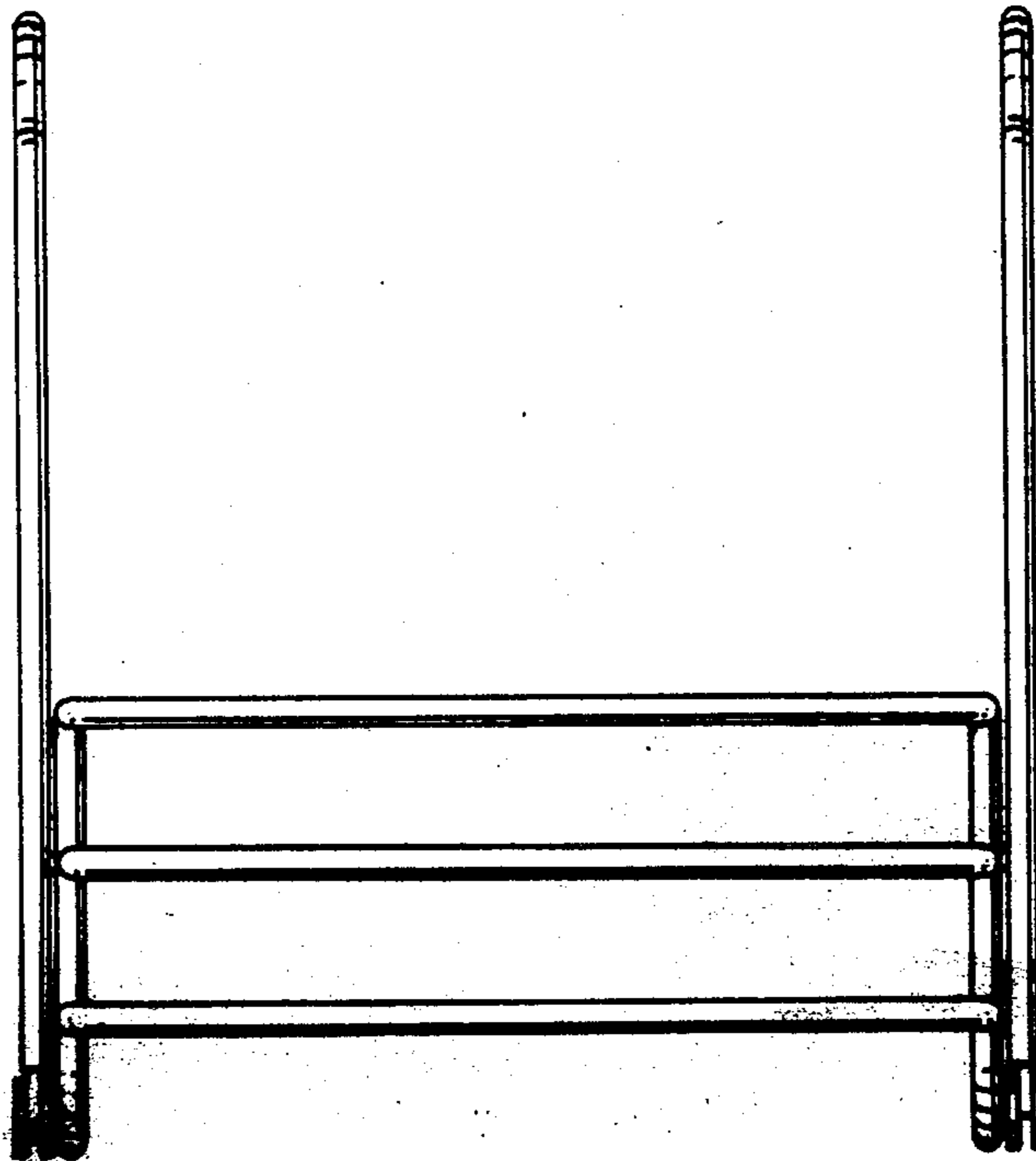

FIG. 3

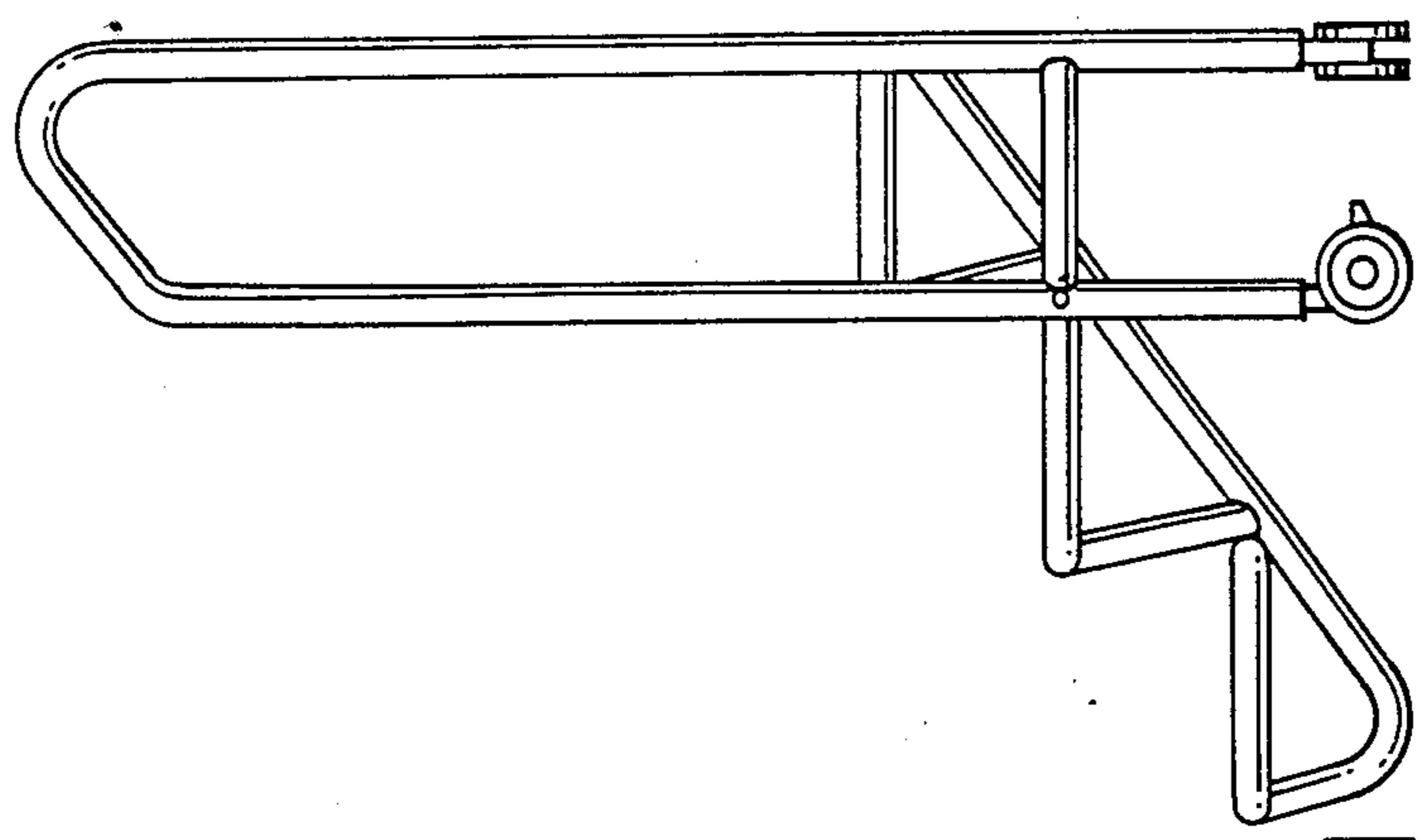

FIG. 2

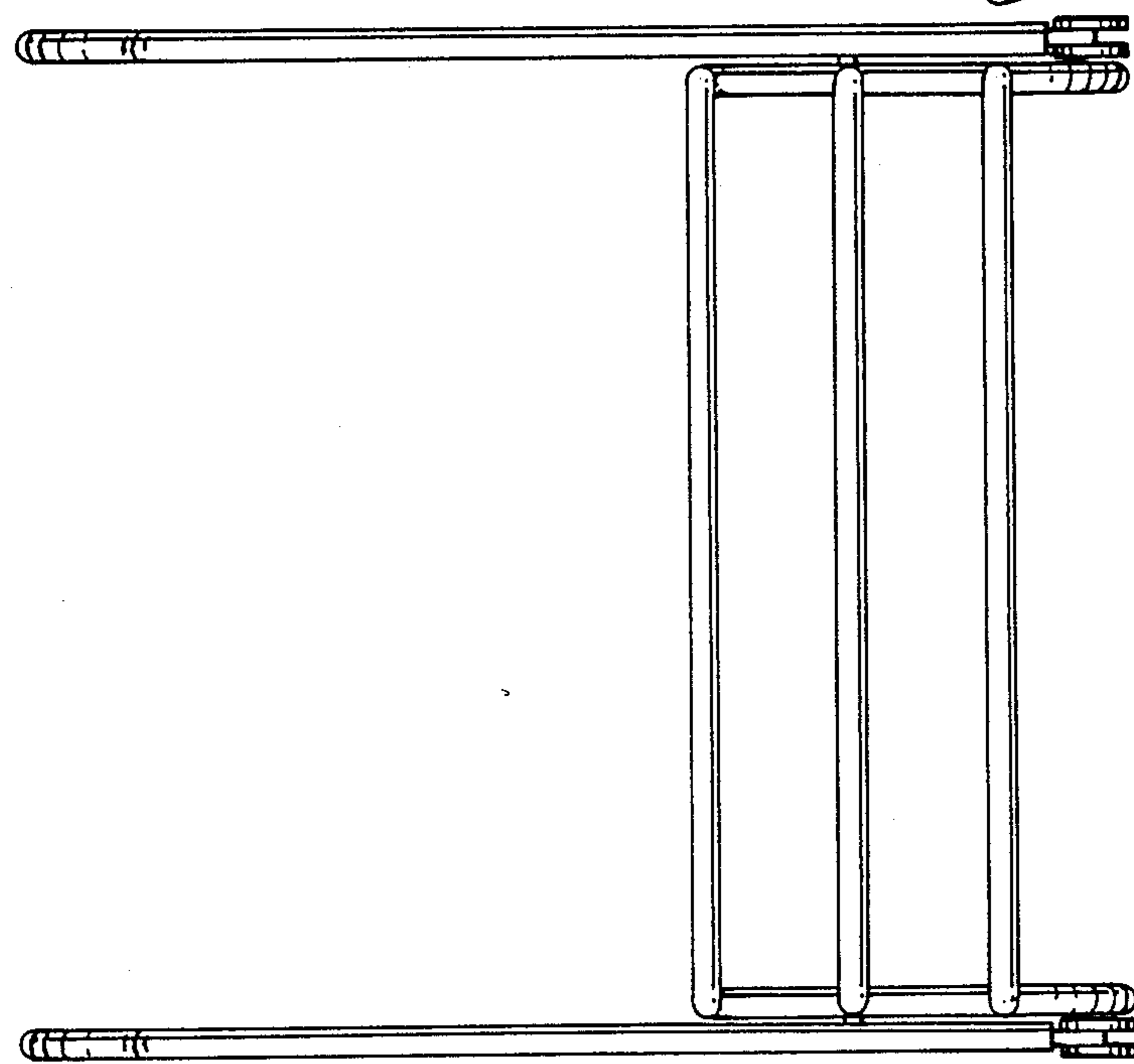

FIG. 1

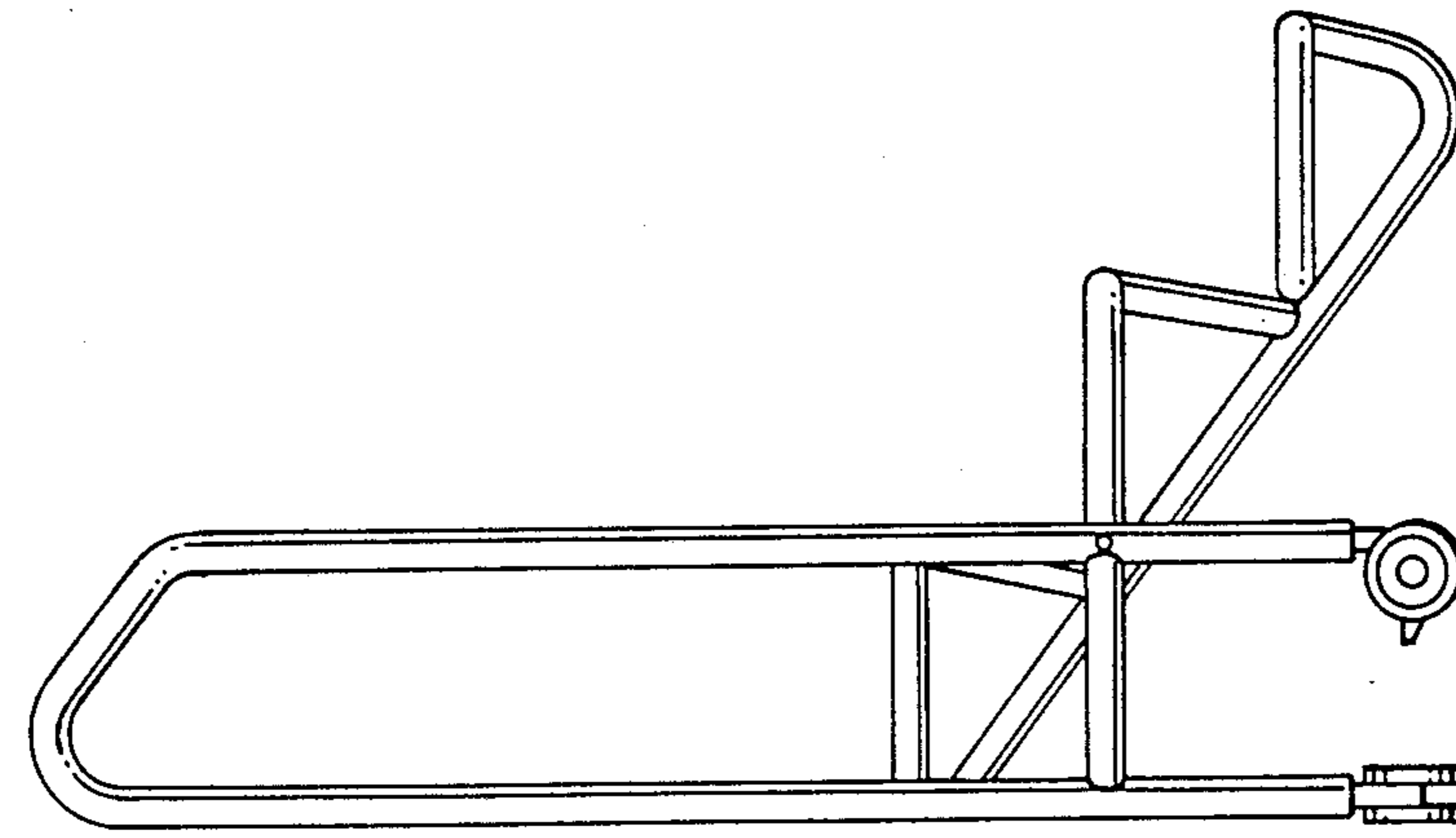

FIG. 5

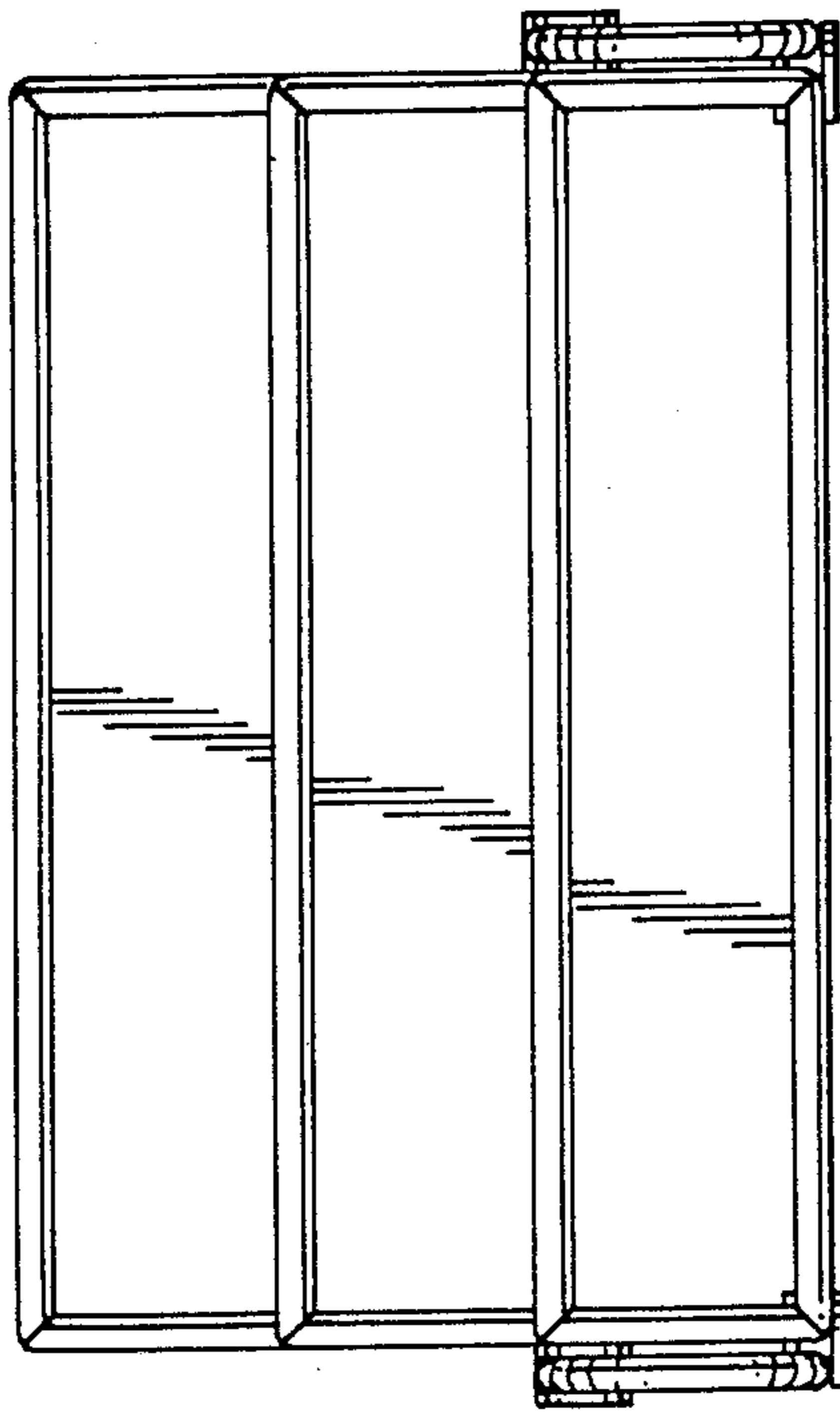

FIG. 6

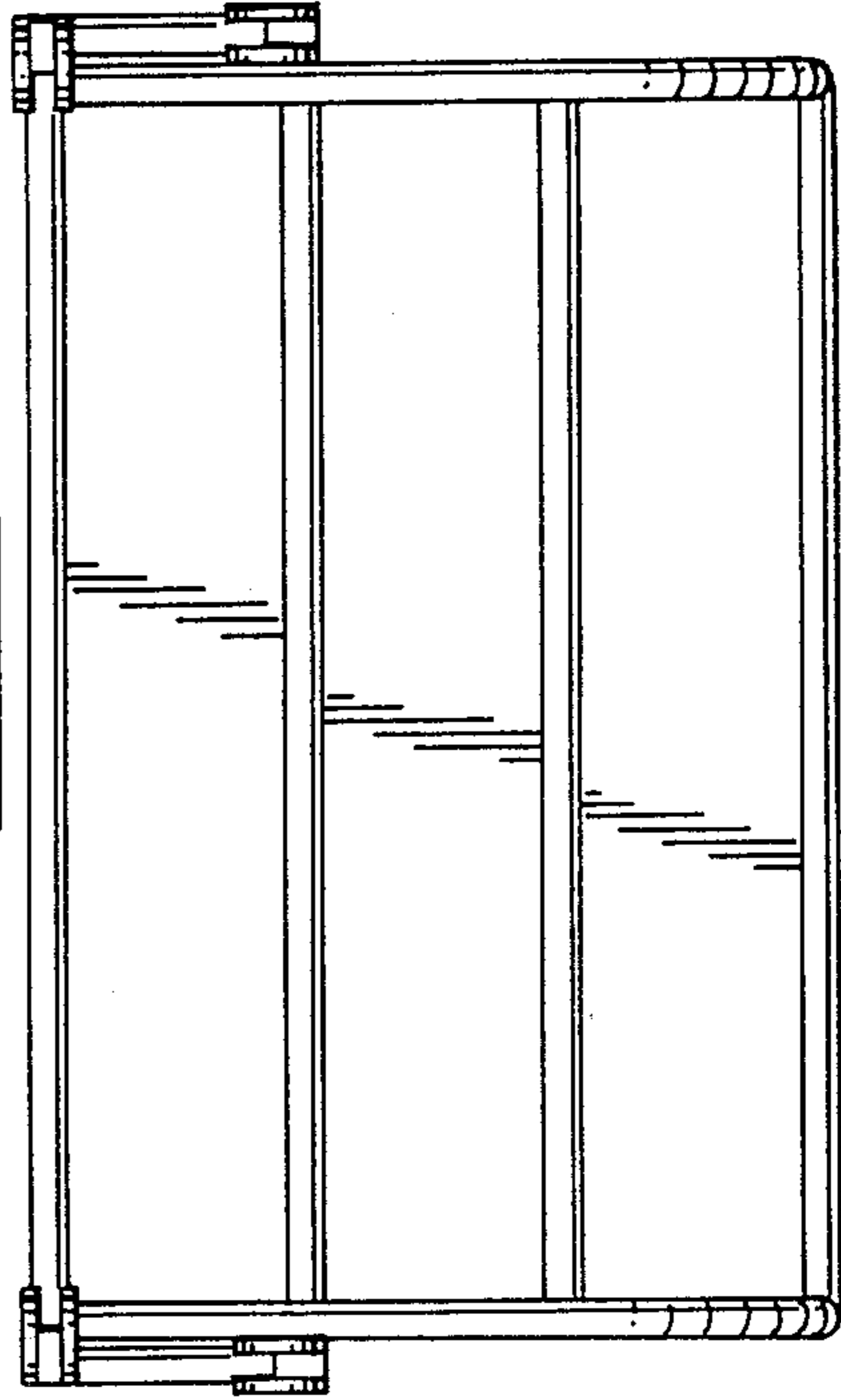

FIG. 4

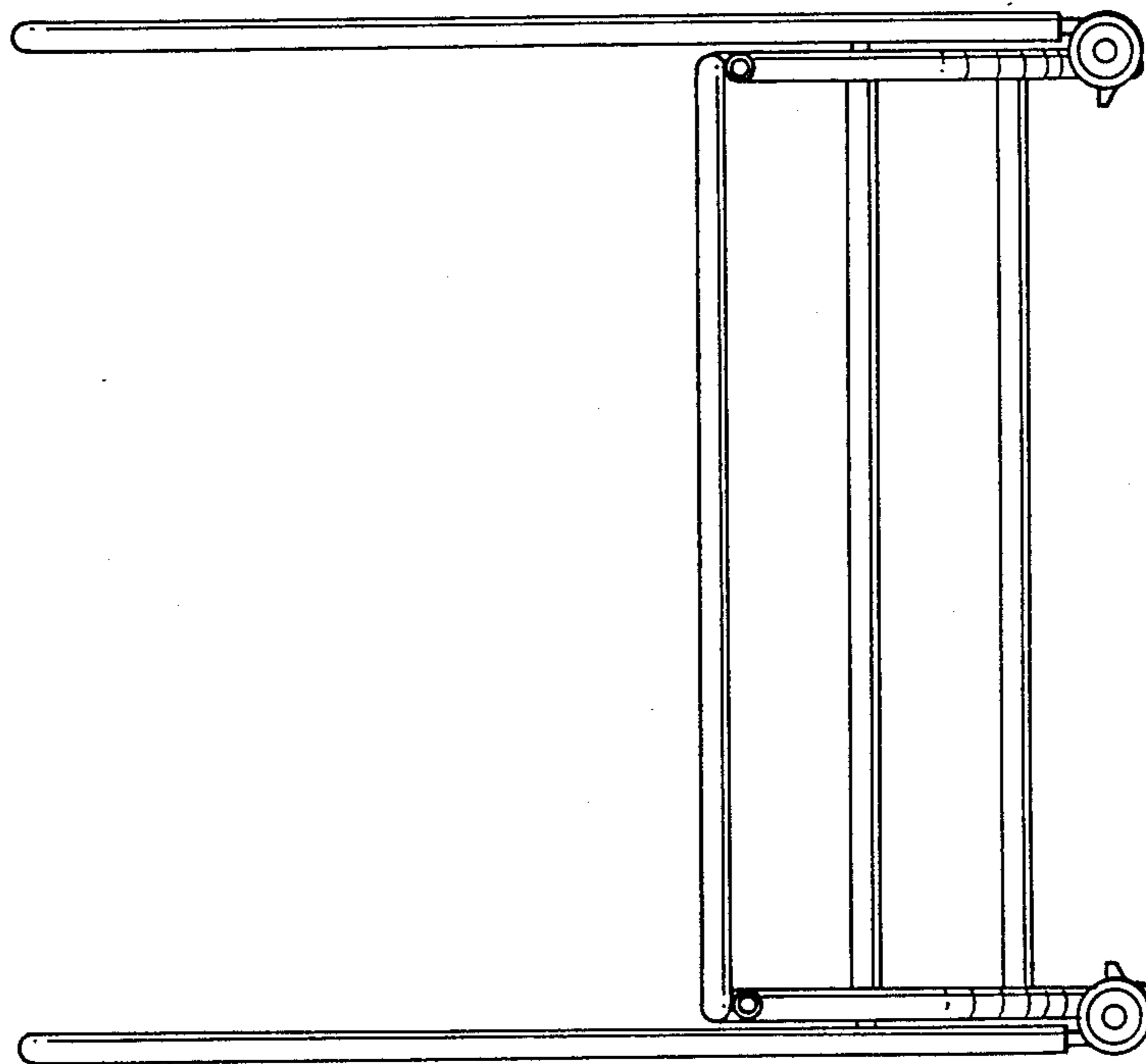

FIG. 7

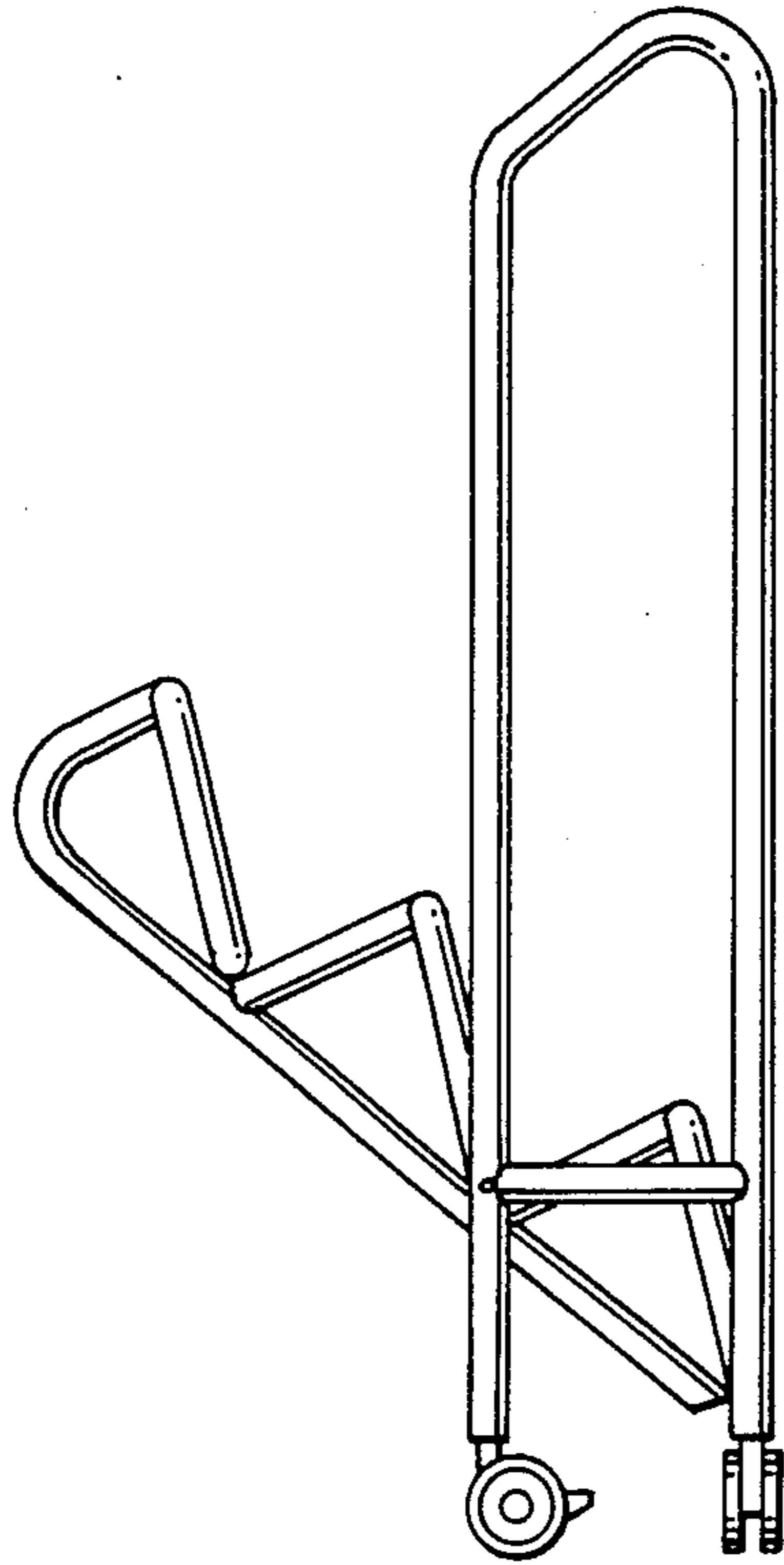

FIG. 8

