

[54] **LITTER SCOOP**
[76] **Inventor: Elliot Elrod, 5254 Enfield, Skokie, Ill. 60077**
[**] **Term: 14 Years**
[21] **Appl. No.: 872,413**
[22] **Filed: Jun. 9, 1986**
[52] **U.S. Cl. D30/162**
[58] **Field of Search D21/206; D30/161-162; 294/1.3, 1.4, 1.5, 55**

3,754,785 8/1973 Anderson 294/1.4 X
3,804,448 4/1974 Schmidler 294/1.4
4,121,866 10/1978 Schall et al. 294/1.4
4,196,928 4/1980 Spangler 294/1.4 X
4,257,635 3/1981 Mainprted 294/1.4
4,349,224 9/1982 Shiozaki 294/1.4

Primary Examiner—James R. Largen

[57] **CLAIM**

The ornamental design for litter scoop, as shown and described.

DESCRIPTION

FIG. 1 is a front elevational view of a litter scoop showing my new design;
FIG. 2 is a left side elevational view thereof;
FIG. 3 is a right side elevational view thereof;
FIG. 4 is a top plan view thereof;
FIG. 5 is a bottom plan view thereof; and
FIG. 6 is a rear elevational view thereof.

[56] **References Cited**
U.S. PATENT DOCUMENTS
D. 205,229 7/1966 Reed D21/206
D. 263,512 3/1982 Kawada D30/162
D. 285,012 8/1986 Willis D30/162
1,659,482 2/1928 Dennemark D21/206 X
3,711,141 1/1973 Soergel 294/1.4 X

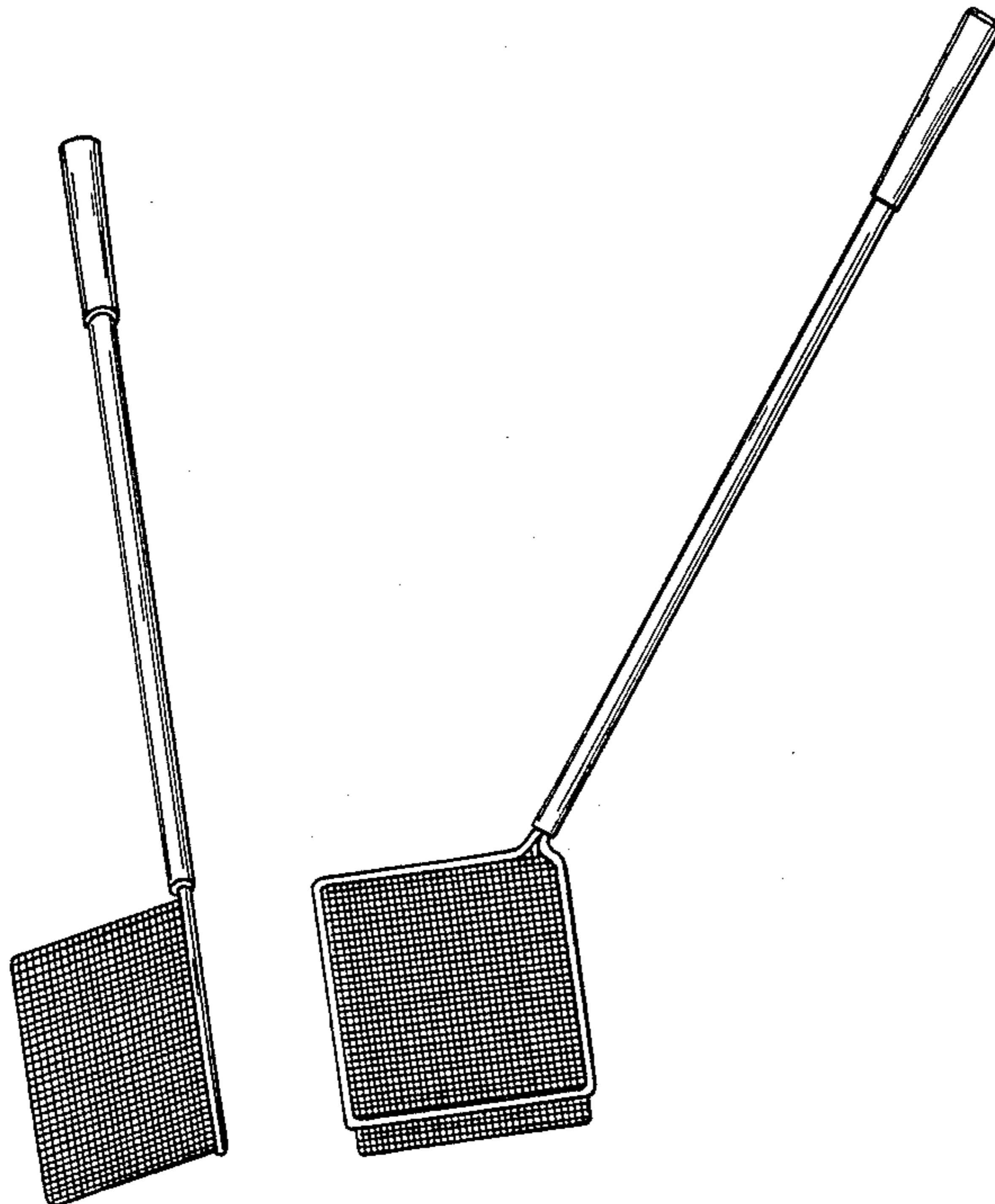

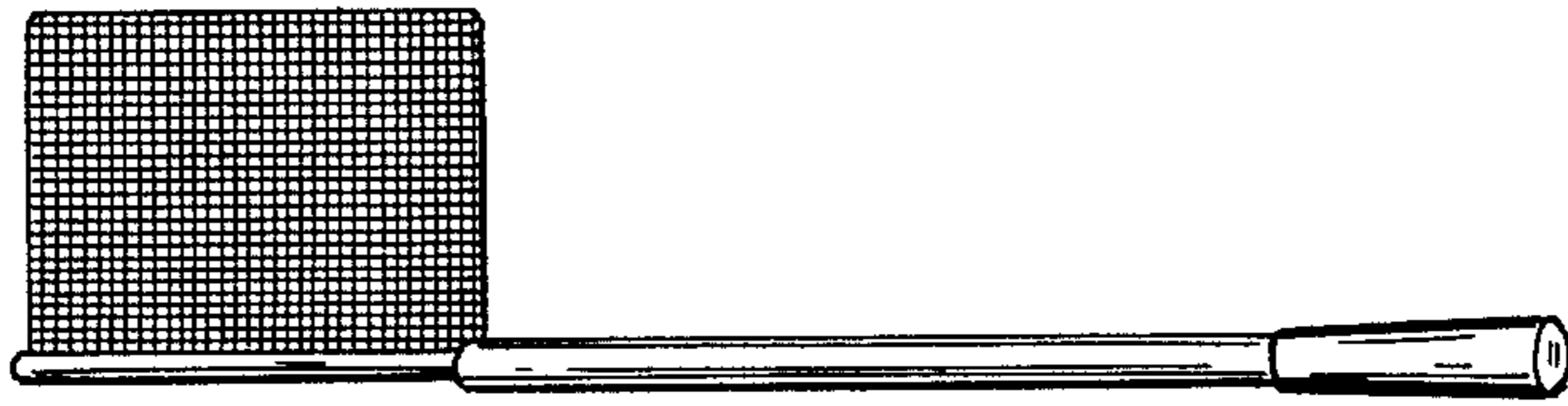

FIG. 4

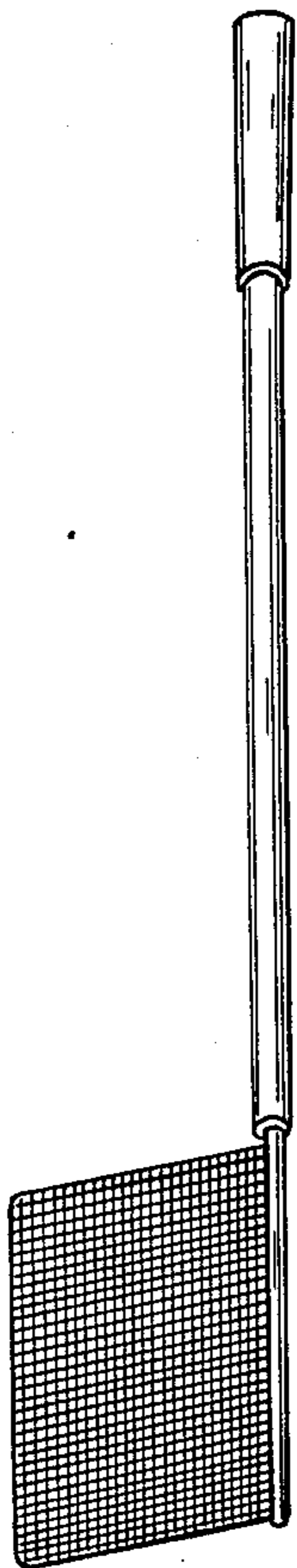

FIG. 2

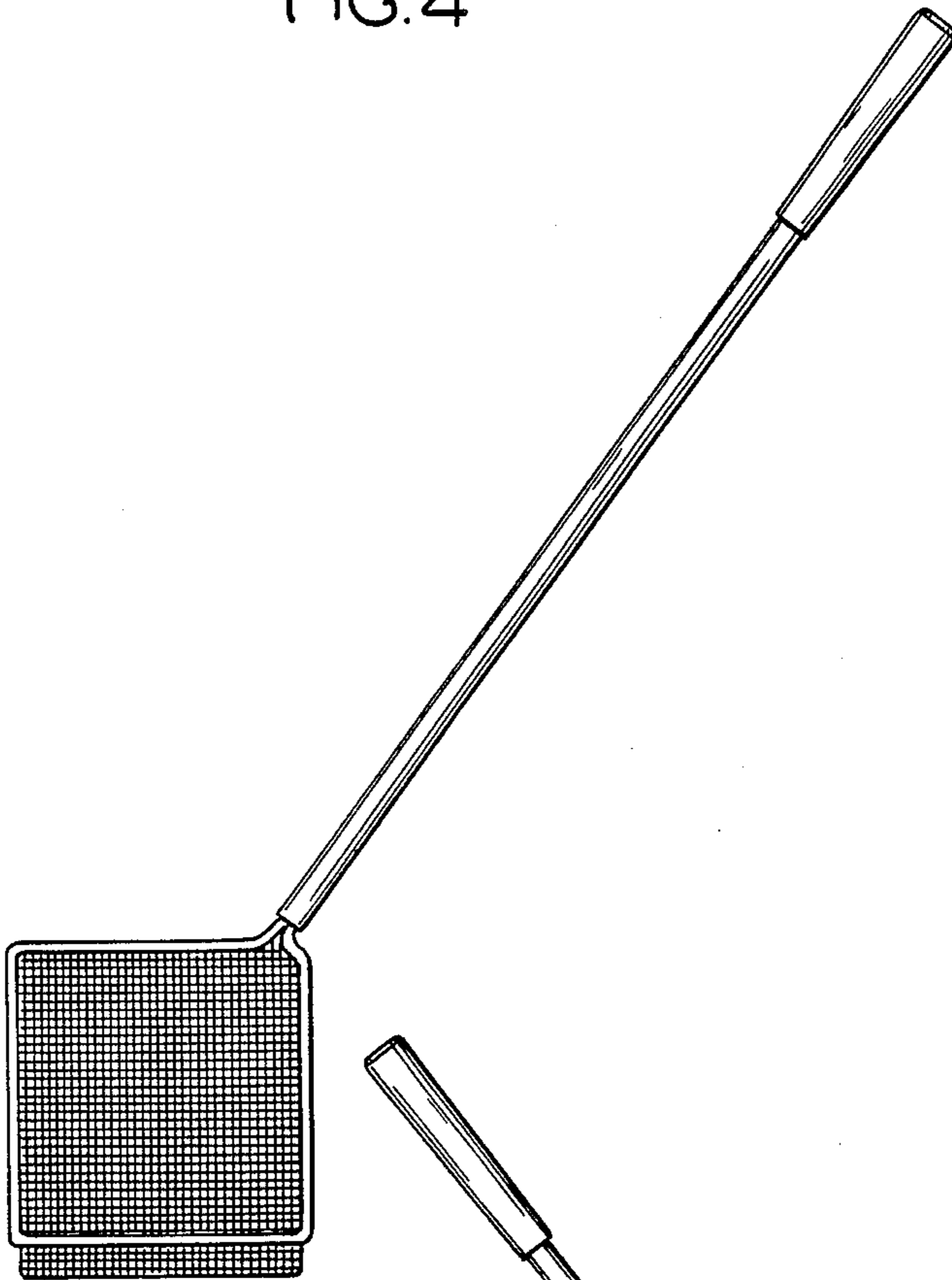

FIG. 1

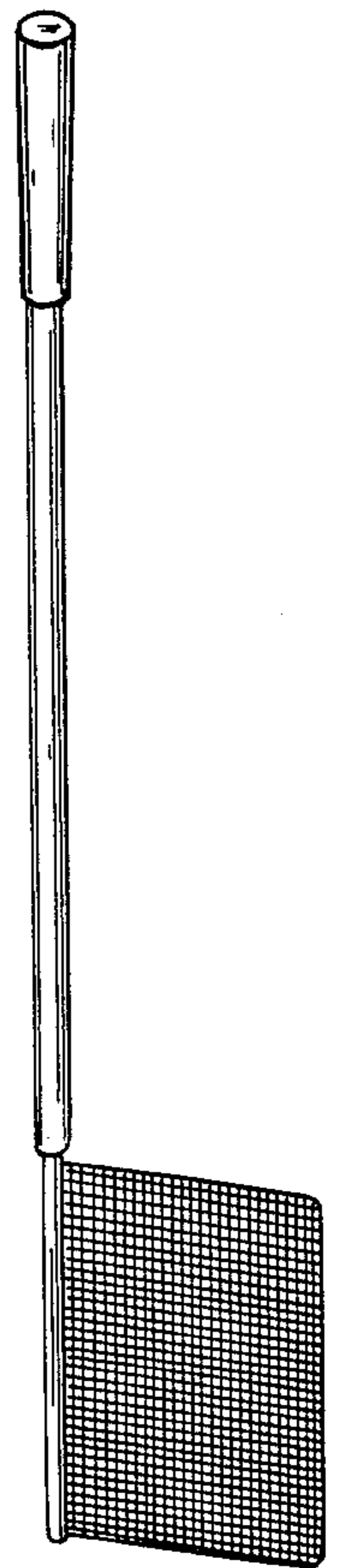

FIG. 3

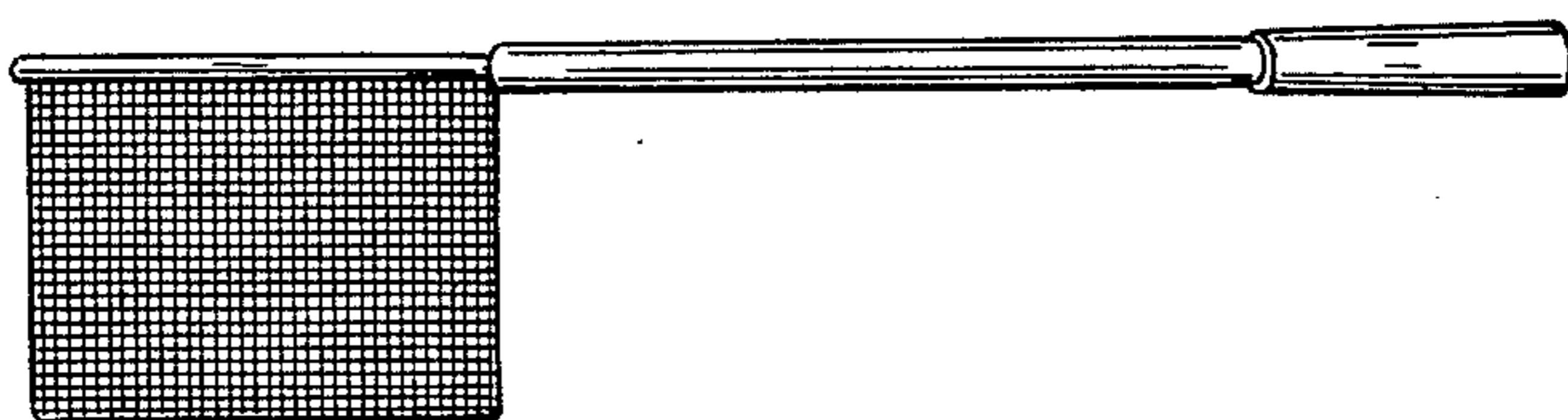

FIG. 5

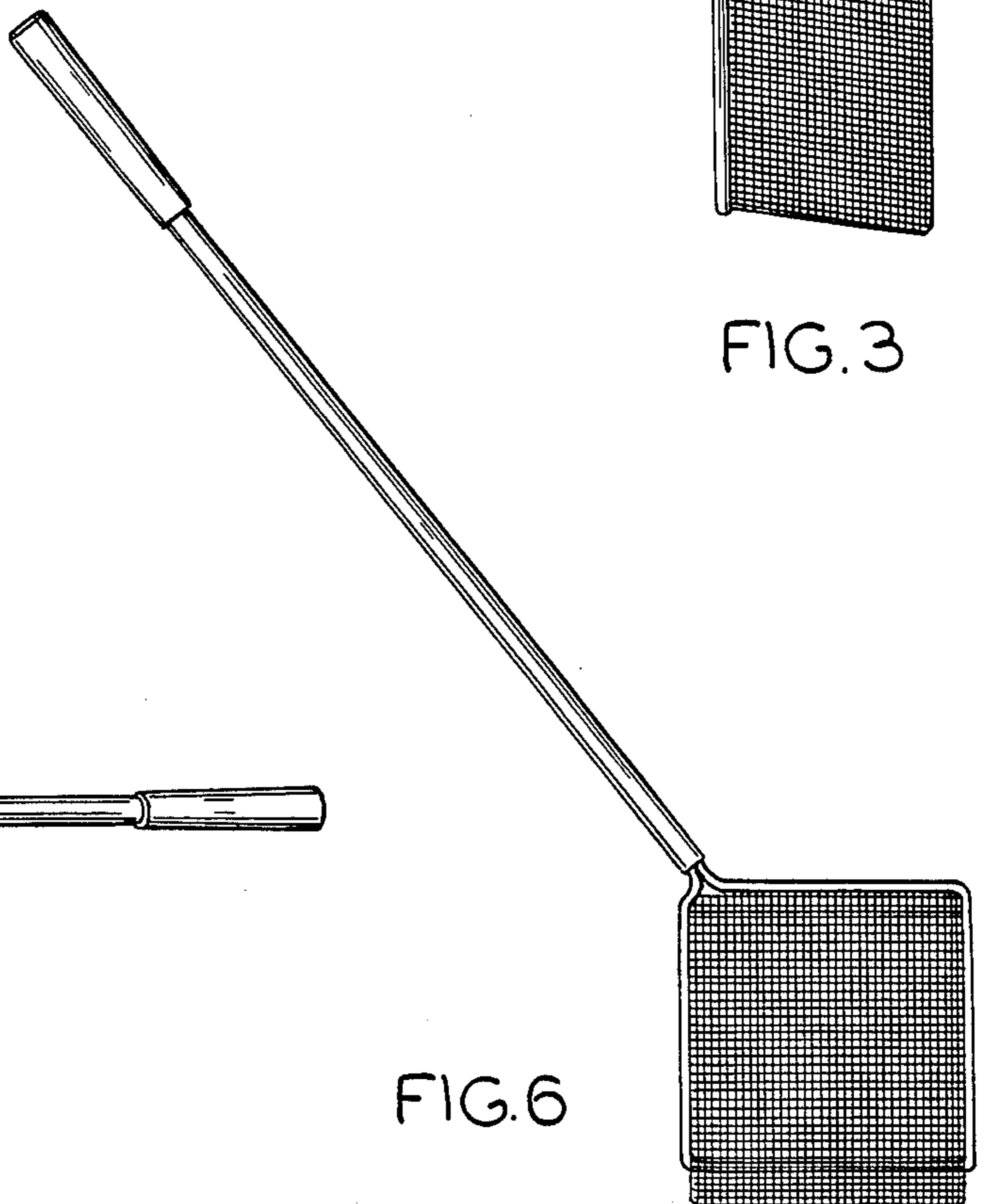

FIG. 6