

[54] AQUARIUM

[75] Inventors: Robert M. Ross, Jr., Garland; Robert J. McNally, Richardson, both of Tex.

[73] Assignee: Great Western Trading Corp., Plano, Tex.

[**] Term: 14 Years

[21] Appl. No.: 194,560

[22] Filed: May 16, 1988

[52] U.S. Cl. D30/102

[58] Field of Search D30/101-107; 119/5; D15/9.1, 9.2, 9.3

D. 81,980	9/1930	Hershman	D15/9.3
D. 93,033	8/1934	Miller	D30/102
D. 95,727	5/1935	Askew	D30/102
D. 166,458	4/1952	Edwards	D30/102
D. 229,839	1/1974	Schlesinger et al.	D30/102
D. 237,556	11/1975	Schlaifer	D15/9.3 X
D. 253,464	11/1979	Elder	D15/9.3 X

Primary Examiner—James R. Largen
Attorney, Agent, or Firm—Neuman, Williams, Anderson & Olson

[57] CLAIM

The ornamental design for an aquarium, as shown and described.

DESCRIPTION

FIG. 1 is a top perspective view of an aquarium showing our new design;

FIG. 2 is a top plan view thereof;

FIG. 3 is a front elevational view thereof;

FIG. 4 is a right side elevational view thereof;

FIG. 5 is a rear elevational view thereof; and

FIG. 6 is a left side elevational view thereof.

[56] References Cited

U.S. PATENT DOCUMENTS

D. 51,986	4/1918	MacKenzie et al.	D15/9.3
D. 52,383	9/1918	Brady	D15/9.3
D. 73,881	11/1927	Townsend	D15/9.3
D. 76,786	11/1928	Eiekmeyer	D15/9.3
D. 78,606	5/1929	Bauman	D15/9.3

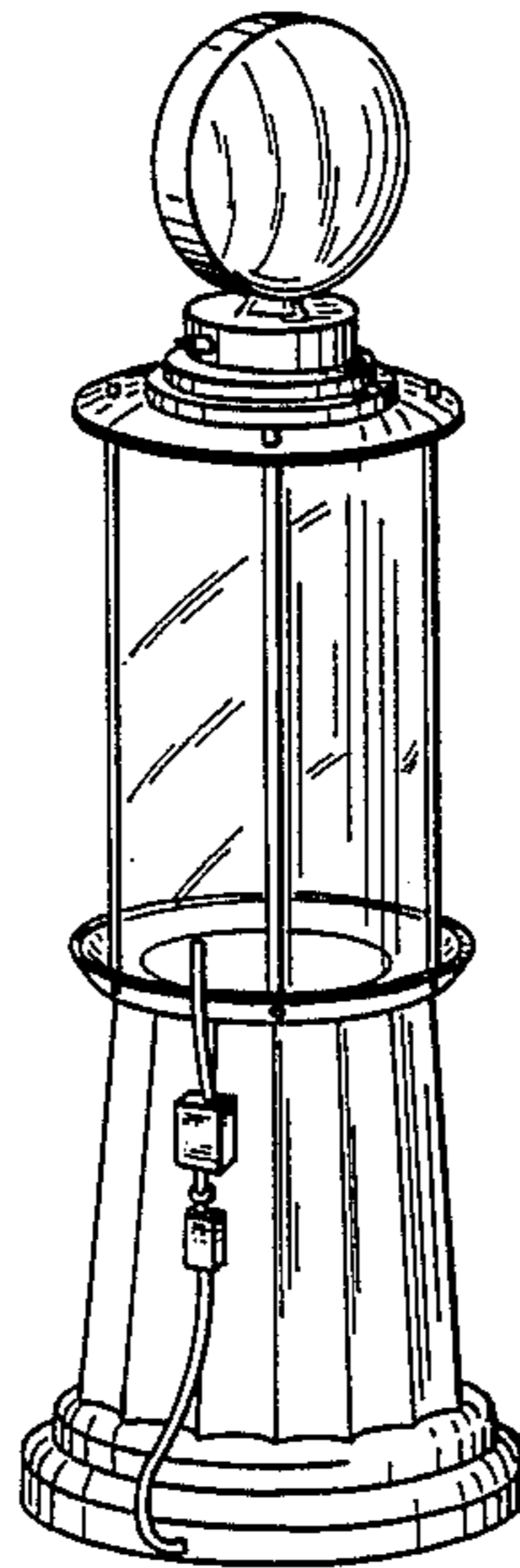

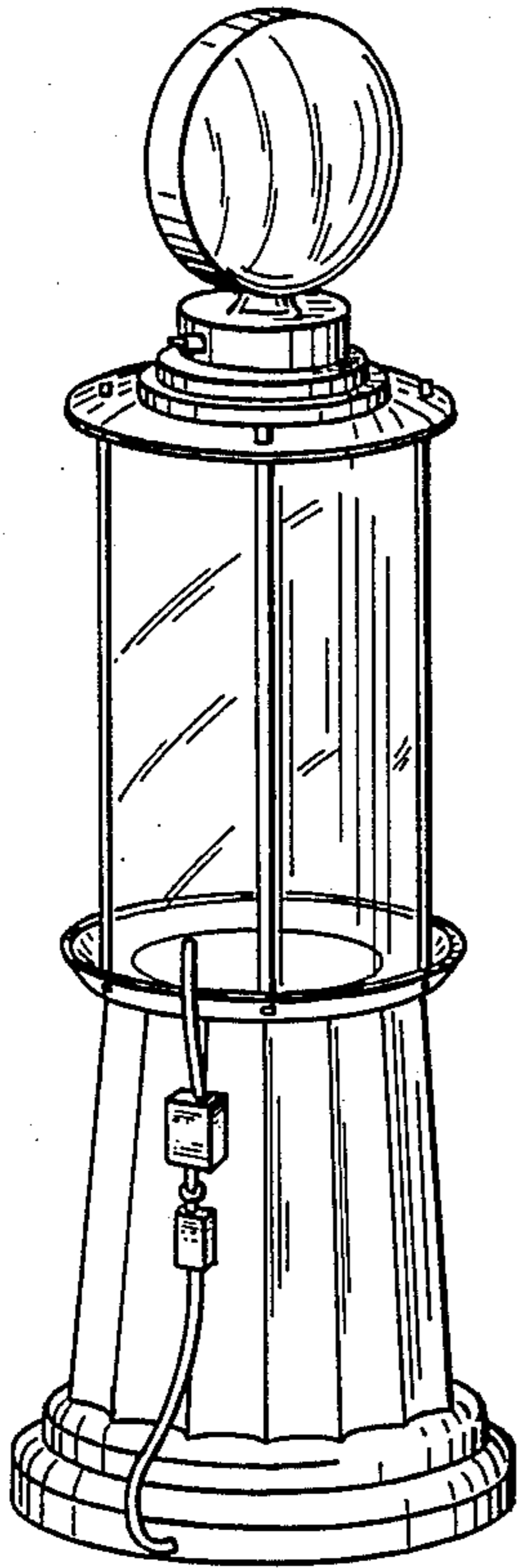

FIG. 1

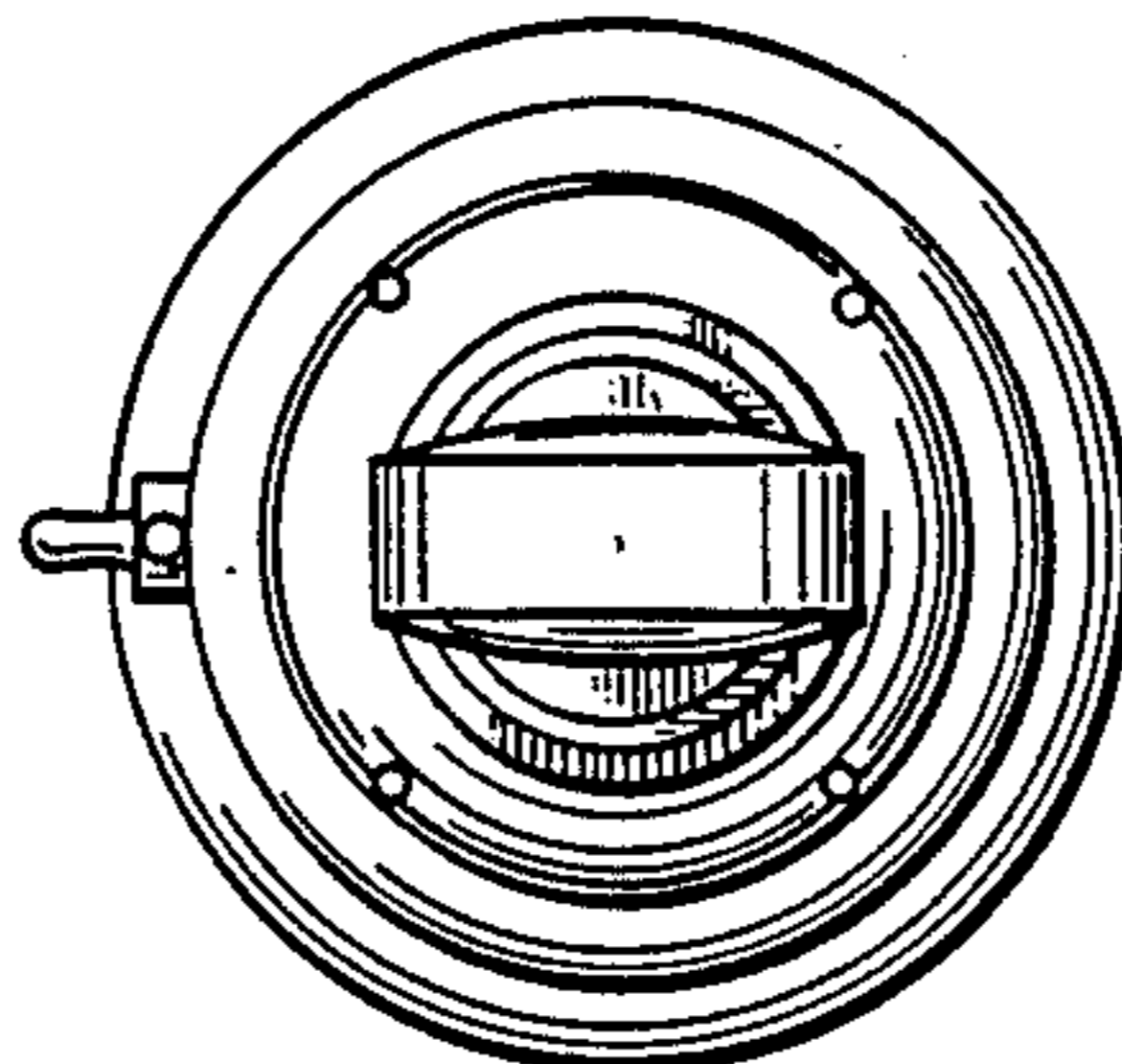

FIG. 2

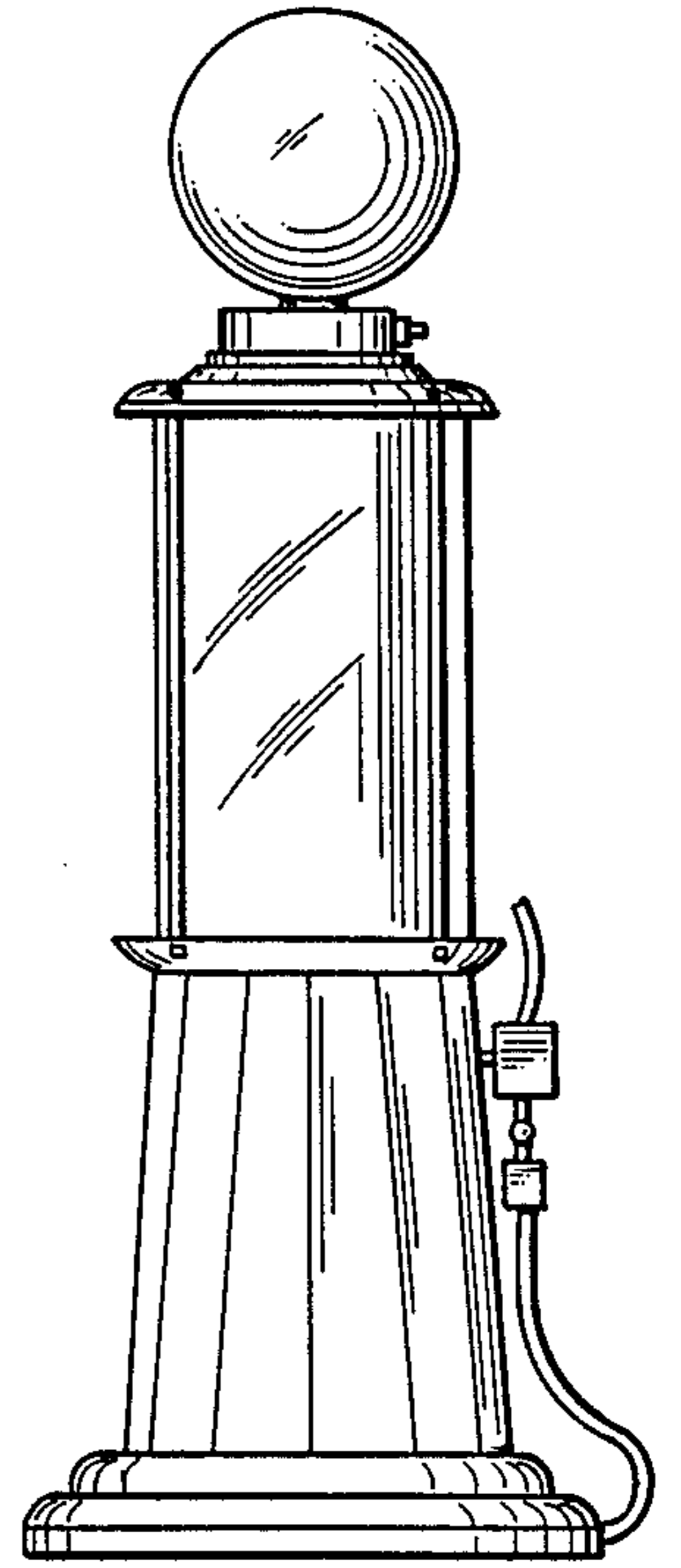

FIG. 3

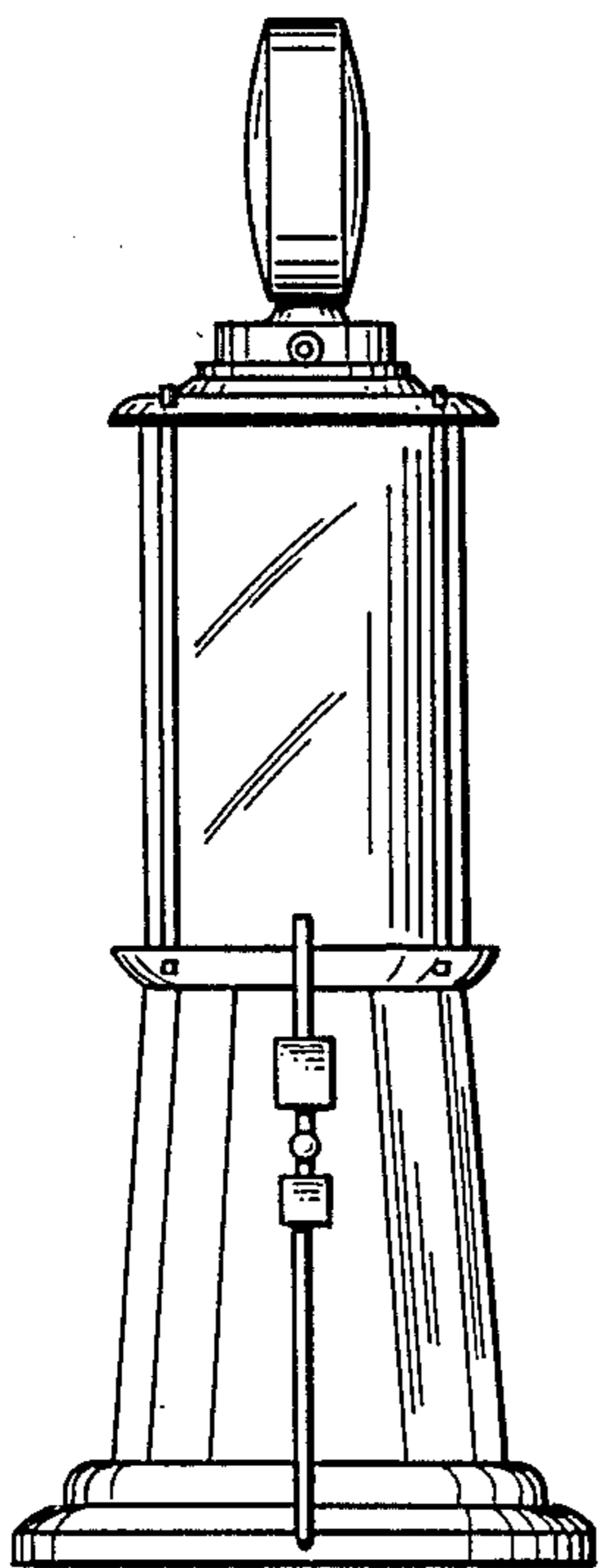

FIG. 4

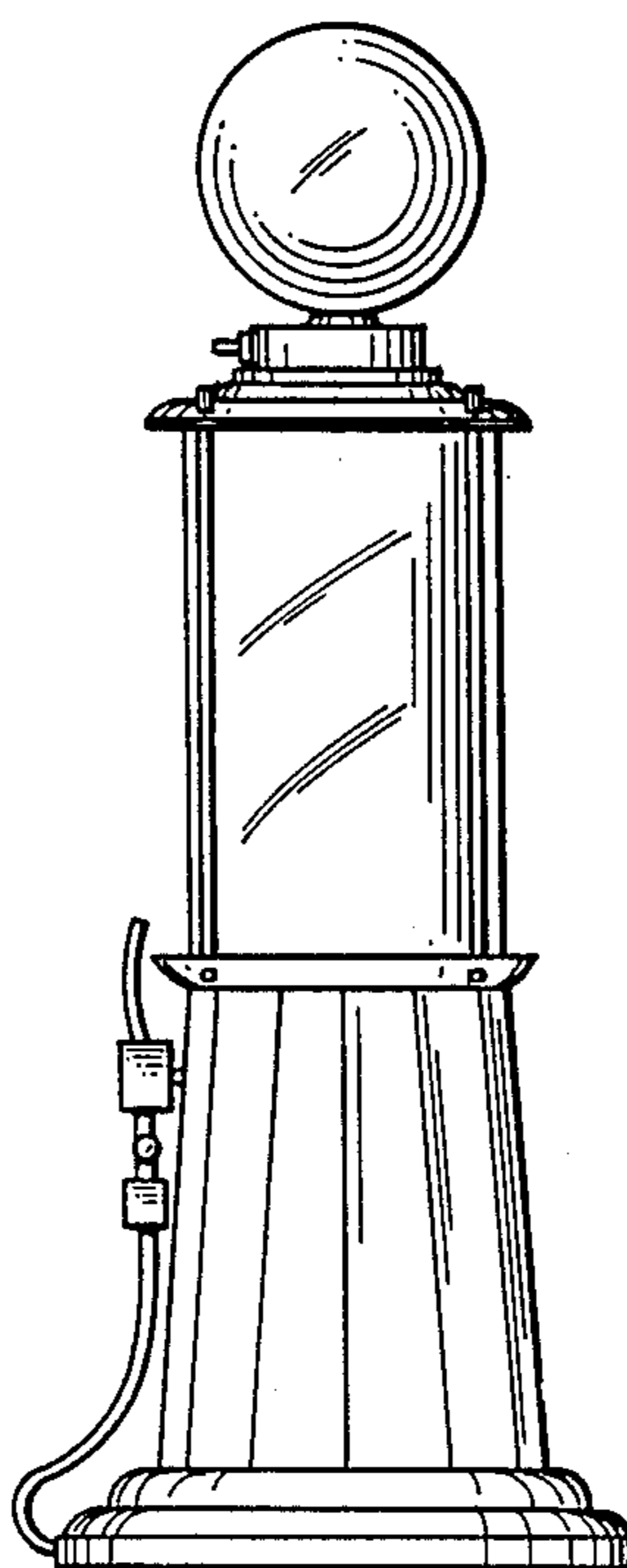

FIG. 5

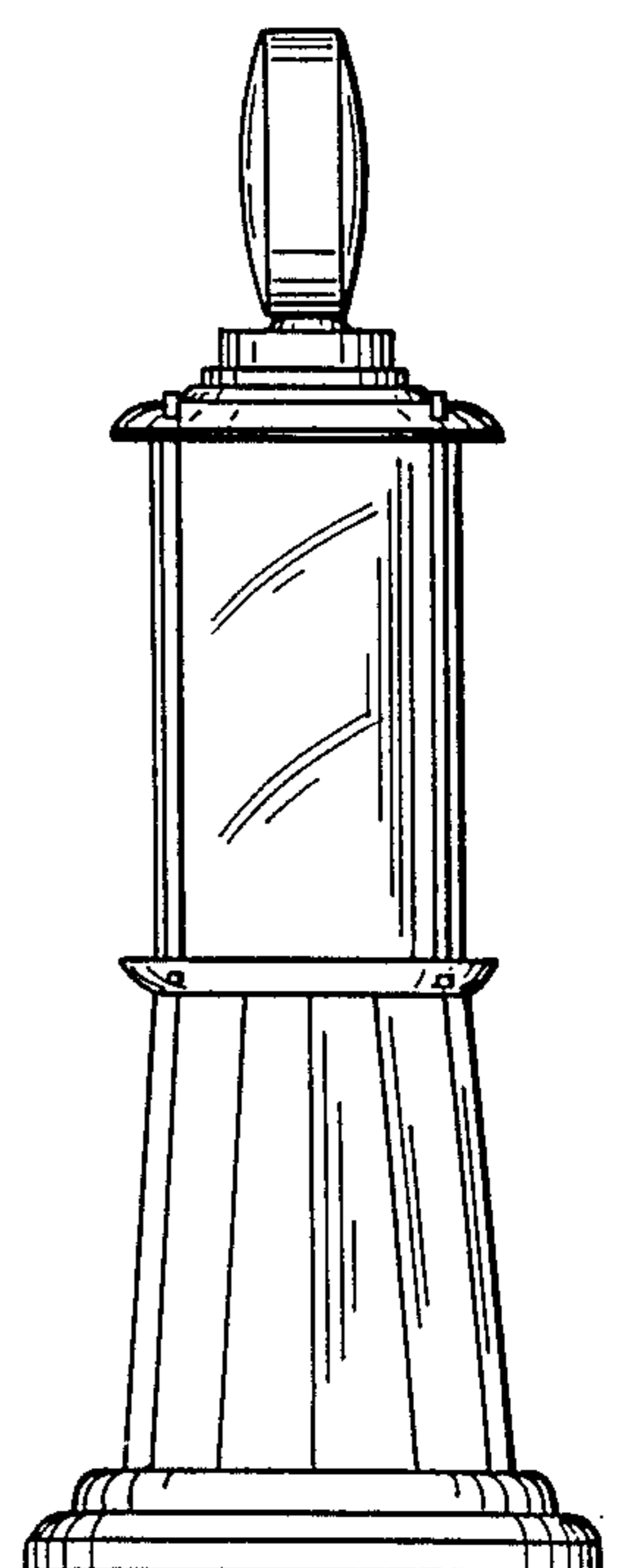

FIG. 6