

# United States Patent [19]

Sawatsky et al.

[11] Patent Number: **Des. 304,206**

[45] Date of Patent: **\*\* Oct. 24, 1989**

## [54] MEMO TRAY

[75] Inventors: **Henry Sawatsky; Richard K. Sawatsky; David P. Sawatsky**, all of Brampton, Canada

[73] Assignee: **Precisioncraft Limited**, Ontario, Canada

[\*\*] Term: **14 Years**

[21] Appl. No.: **824,566**

[22] Filed: **Jan. 23, 1986**

### [30] Foreign Application Priority Data

Nov. 27, 1985 [CA] Canada ..... 27-11-85-1

[52] U.S. Cl. .... **D19/86; D19/75**

[58] Field of Search ..... **D19/75, 86, 90, 91, D19/92, 95, 98, 99, 78; 281/15 B, 1; 282/22 A, 23 A, 25, 29 R**

### [56] References Cited

#### U.S. PATENT DOCUMENTS

D. 182,451 4/1958 Brandon ..... D19/86  
D. 194,860 3/1963 Downs ..... D19/99  
2,633,373 3/1953 Marano ..... 281/15 B

### FOREIGN PATENT DOCUMENTS

221076 9/1924 United Kingdom ..... 281/15 B

### OTHER PUBLICATIONS

Hongkong Enterprise, vol. 4 of 1984, p. 186, Item No. 318 (shown by arrow).

Honkong Enterprise Catalog, vol. 12 of 1980, p. 225, Art No. 2003.

*Primary Examiner*—Bernard Ansher

*Assistant Examiner*—Prabhakar Deshmukh

*Attorney, Agent, or Firm*—Bernard, Rothwell & Brown

### [57] CLAIM

The ornamental design for memo tray as shown and described.

### DESCRIPTION

FIG. 1 is a perspective view of a memo tray showing my new design;

FIG. 2 is a top plan view thereof;

FIG. 3 is a bottom plan view thereof;

FIG. 4 is a left side elevation thereof; the undisclosed right side is similar to the left side elevation shown;

FIG. 5 is a front elevation thereof; and

FIG. 6 is a rear elevation thereof.

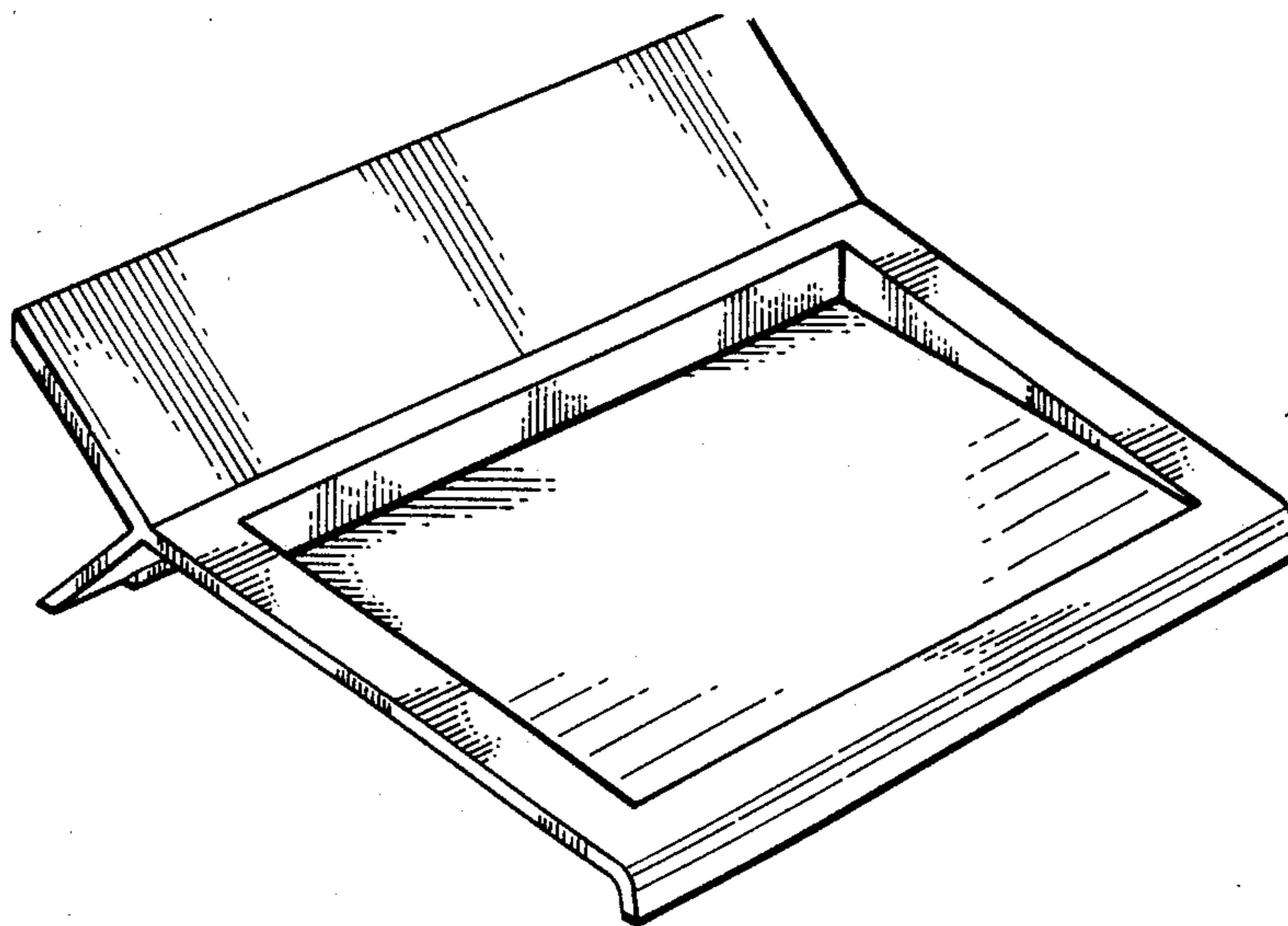

FIG. 1.

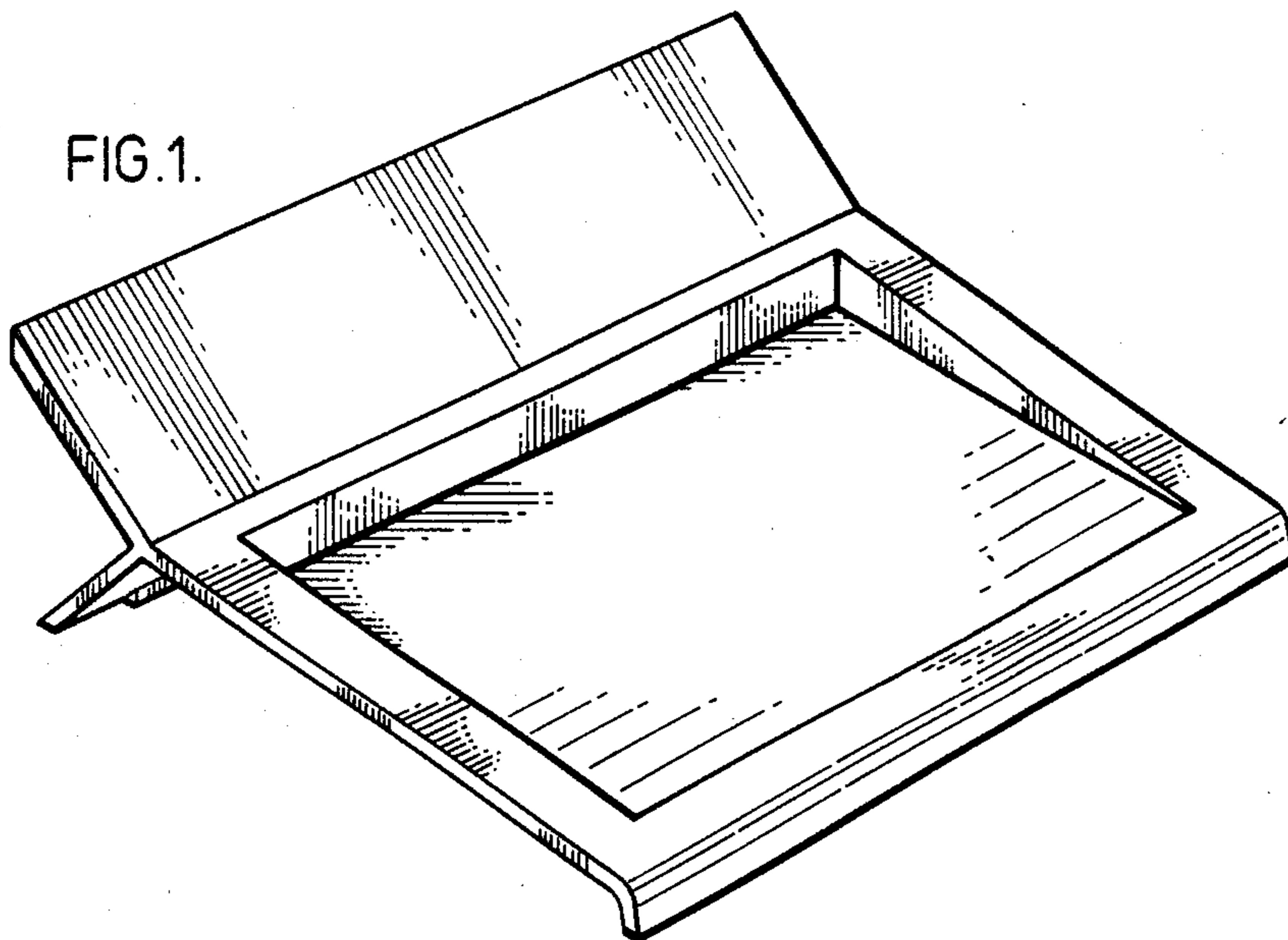
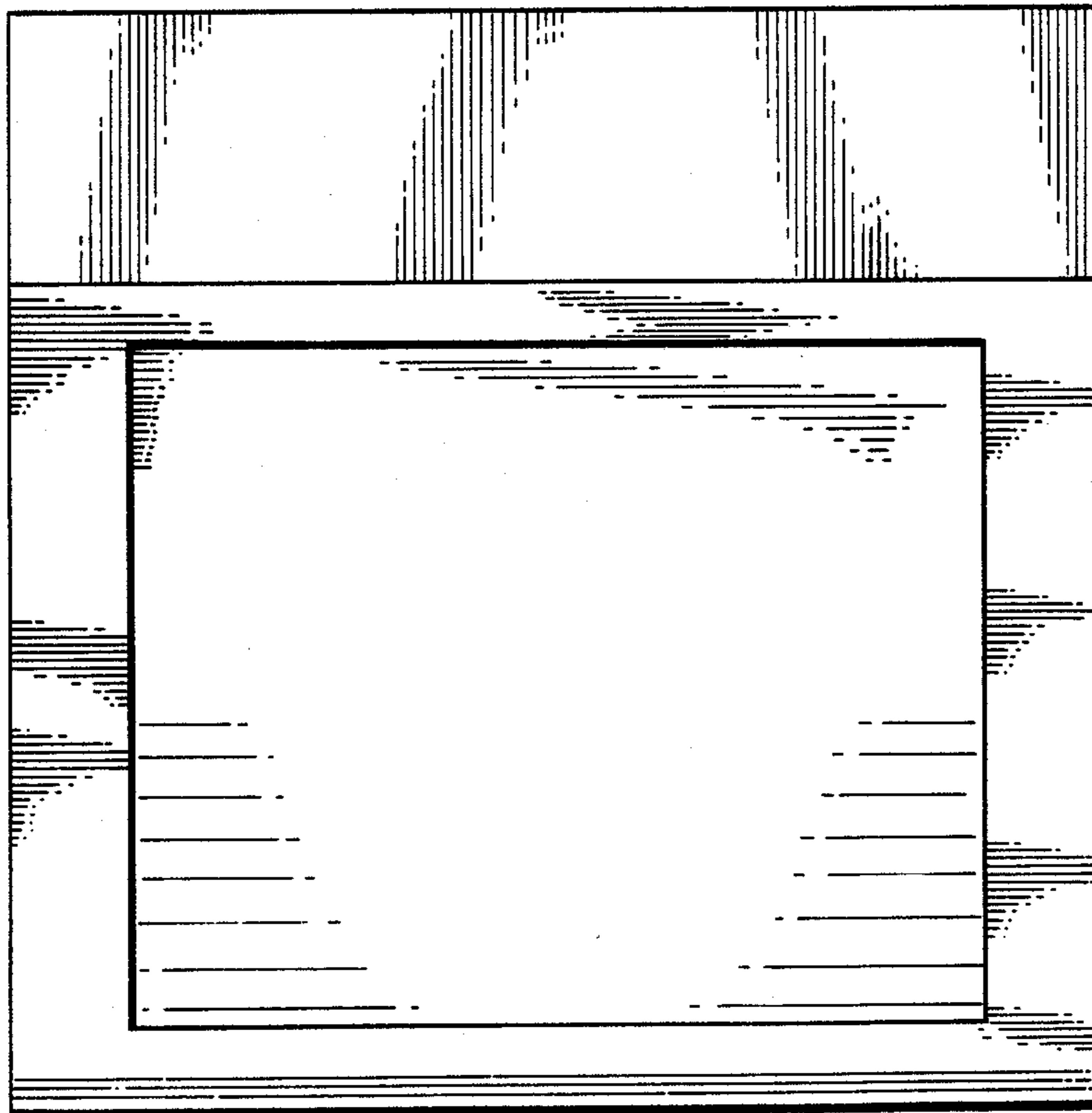

FIG. 2.



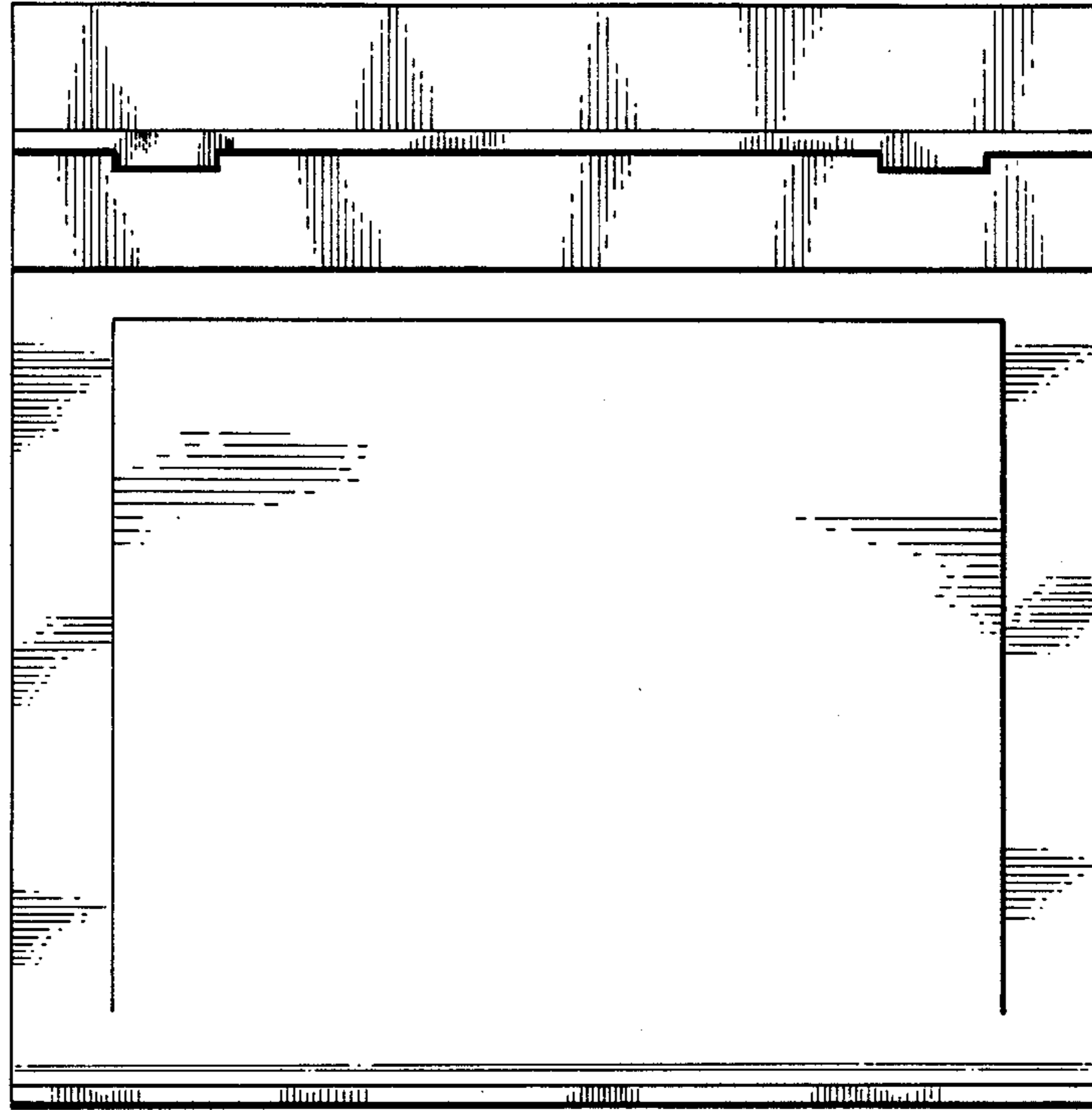

FIG. 3.

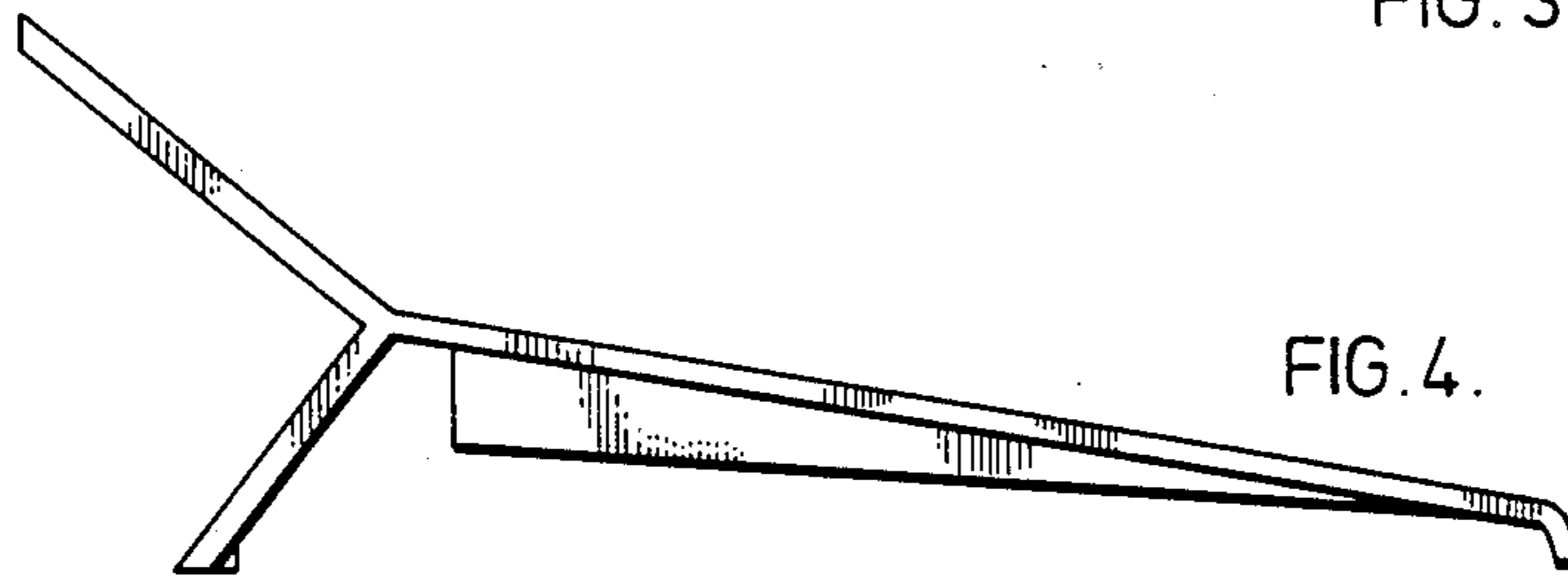

FIG. 4.

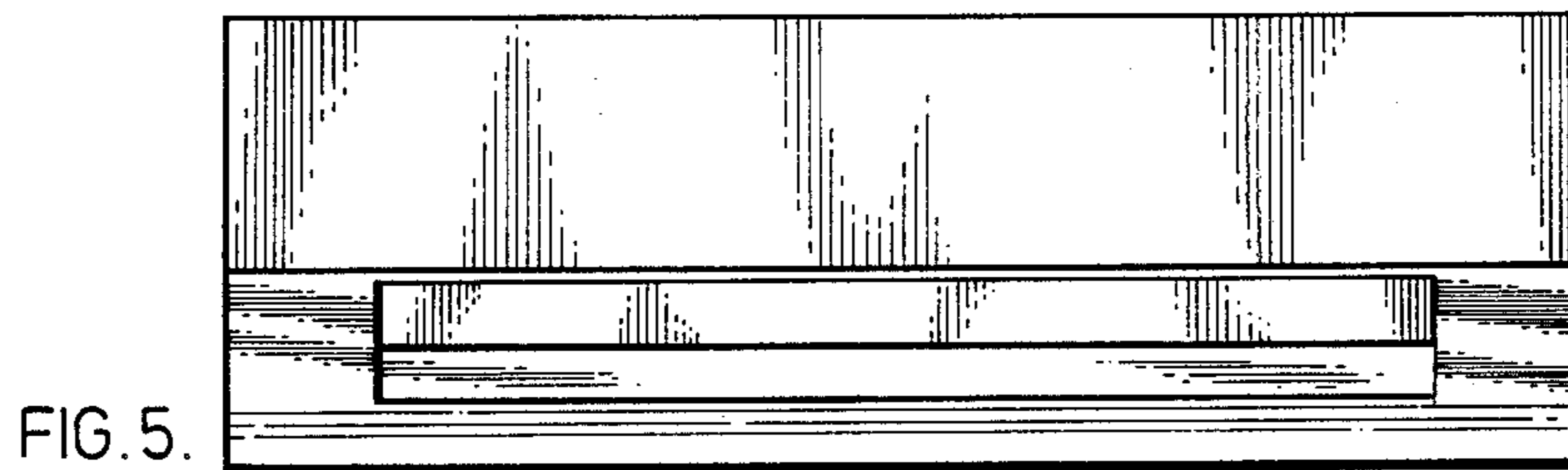

FIG. 5.

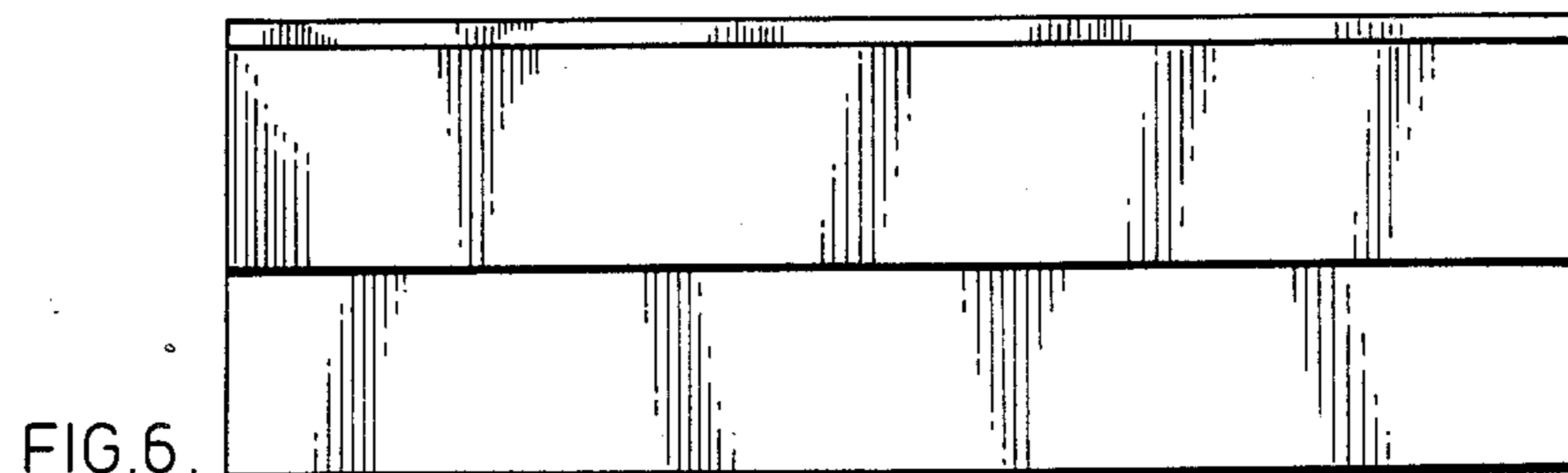

FIG. 6.