

[54] FACSIMILE

[75] Inventors: Kuno Hara, Chiba; Shin-ichi Hiroki, Tokyo, both of Japan

[73] Assignee: Kabushiki Kaisha Toshiba, Kawasaki, Japan

[**] Term: 14 Years

[21] Appl. No.: 55,742

[22] Filed: May 29, 1987

[30] Foreign Application Priority Data

Dec. 8, 1986 [JP] Japan 61-48253

[52] U.S. Cl. D14/118

[58] Field of Search D14/118, 142, 144, 151; D18/36, 37; 358/256, 286

[56] References Cited

U.S. PATENT DOCUMENTS

- D. 295,750 5/1988 Imai D14/118 X
- D. 299,494 1/1989 Tsuruoka D14/118
- D. 300,139 3/1989 Nishio D14/118

FOREIGN PATENT DOCUMENTS

- 36-18766 5/1961 Japan .
- 36-27517 7/1961 Japan .

OTHER PUBLICATIONS

The Office, Sep. 1987, p. 148, right—Facsimile System.
The Office, Sept. 1987, p. 146, right—Facsimile Transceiver.

Canon Catalog of Canofax 110 received by the assignee company on Feb. 21, 1987.

Canon Canofax 110 shown in "Nikkei Sangyo Shim-bun" Pub. 2-4-86.

SHOP FAX of Matsushita Electric Ind. Co., Ltd. shown in "Dempa Shimbun" advertisement.

G-3 Facsimile 'UF-5' of Matsushita Facsimile Co., Ltd. shown in "Dempa Shimbun" published Mar. 26, 1986. NEC catalog of NEFAX-5.

Primary Examiner—Bernard Ansher

Assistant Examiner—Theodore M. Shooman

Attorney, Agent, or Firm—Oblon, Spivak, McClelland, Maier & Neustadt

[57] CLAIM

The ornamental design for a facsimile, as shown and described.

DESCRIPTION

FIG. 1 is a right top perspective view of a facsimile showing our new design;

FIG. 2 is a top plan view thereof;

FIG. 3 is a front elevational view thereof;

FIG. 4 is a right side elevational view thereof;

FIG. 5 is a left side elevational view thereof;

FIG. 6 is a rear elevational view thereof;

FIG. 7 is a bottom plan view thereof;

FIG. 8 is a left top perspective view thereof with the handset spaced apart from the console; and

FIG. 9 is a right top perspective view of FIG. 1, the broken line showings of sheets being environmental only and forming no part of the claimed design.

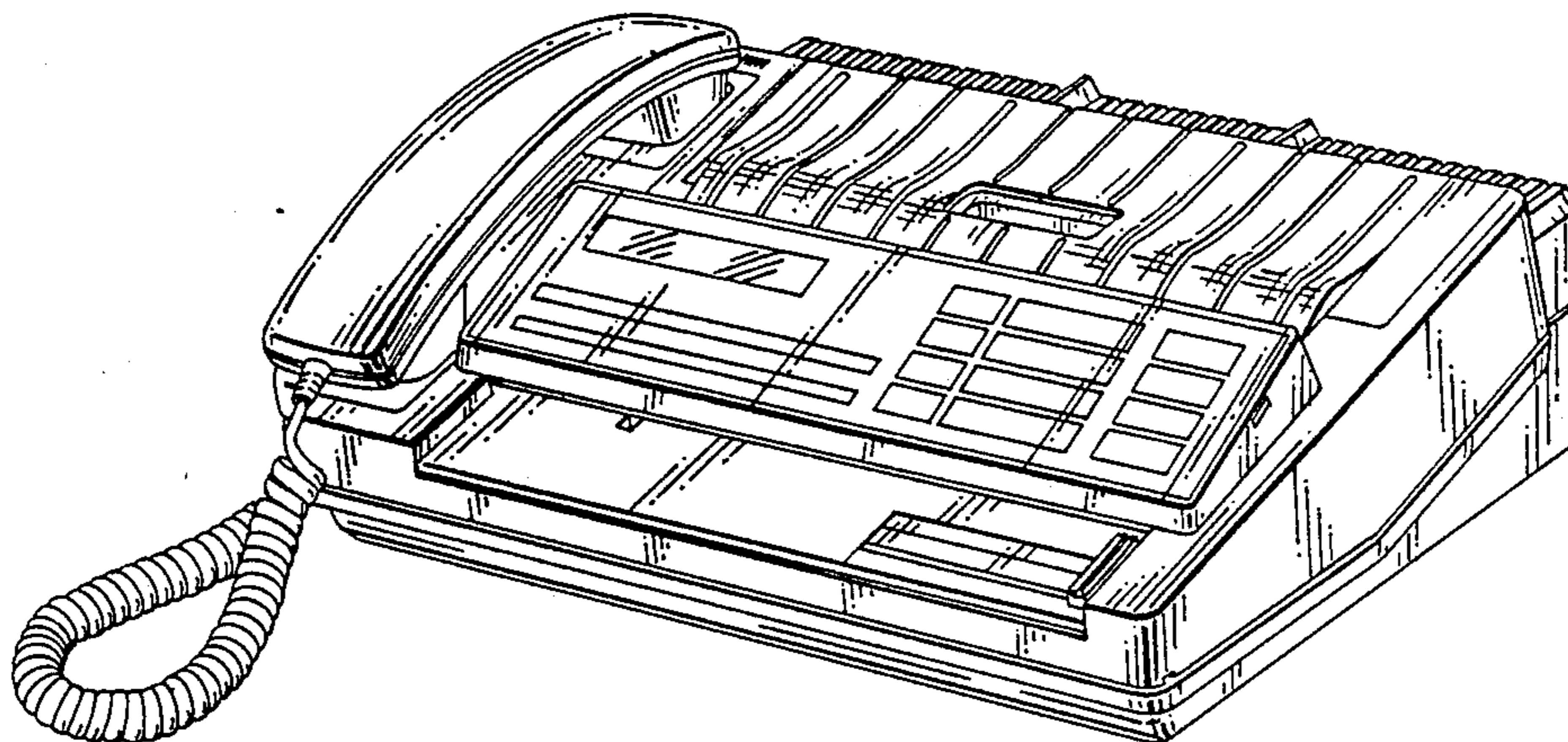

FIG. 1

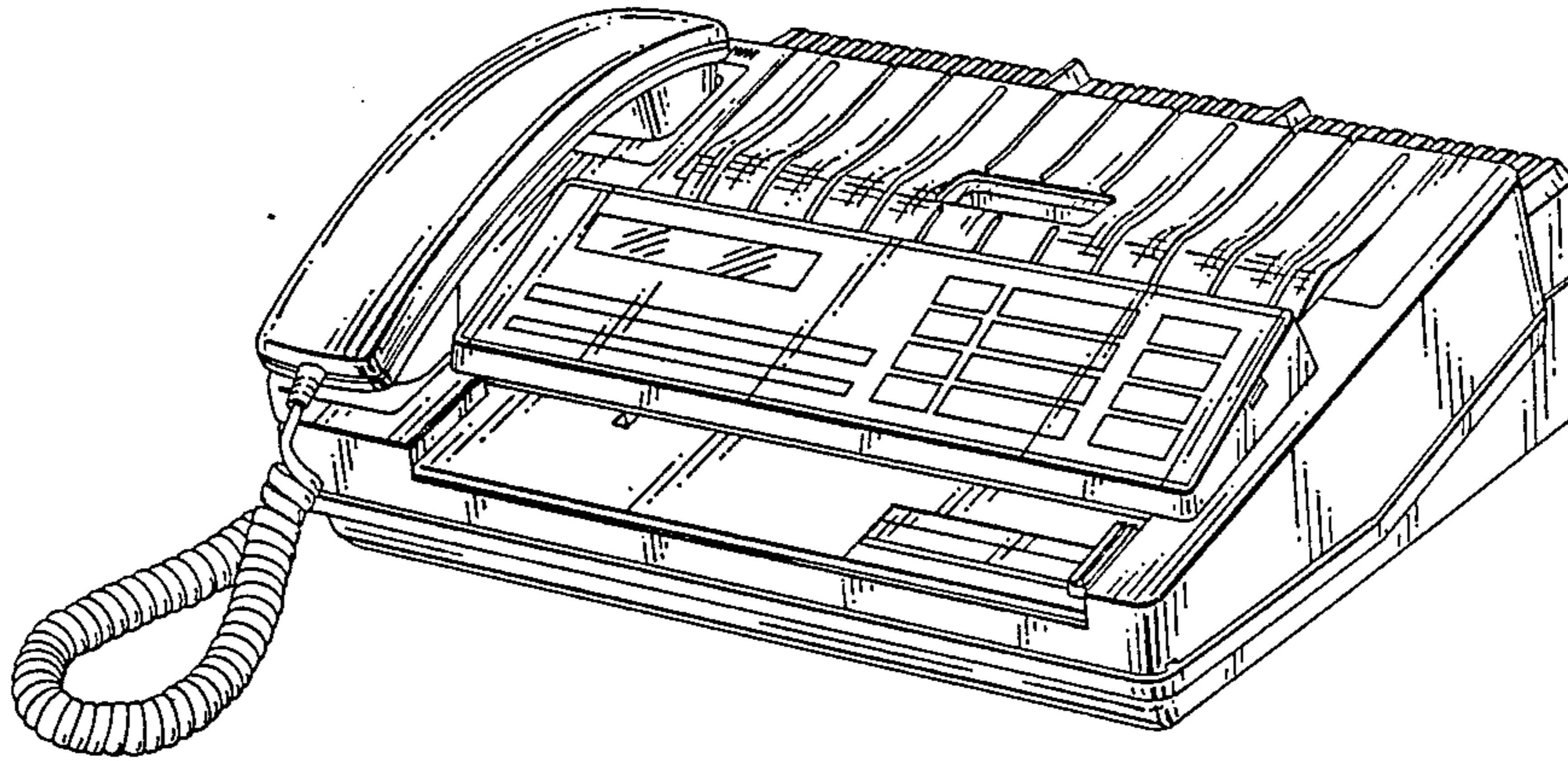

FIG. 2

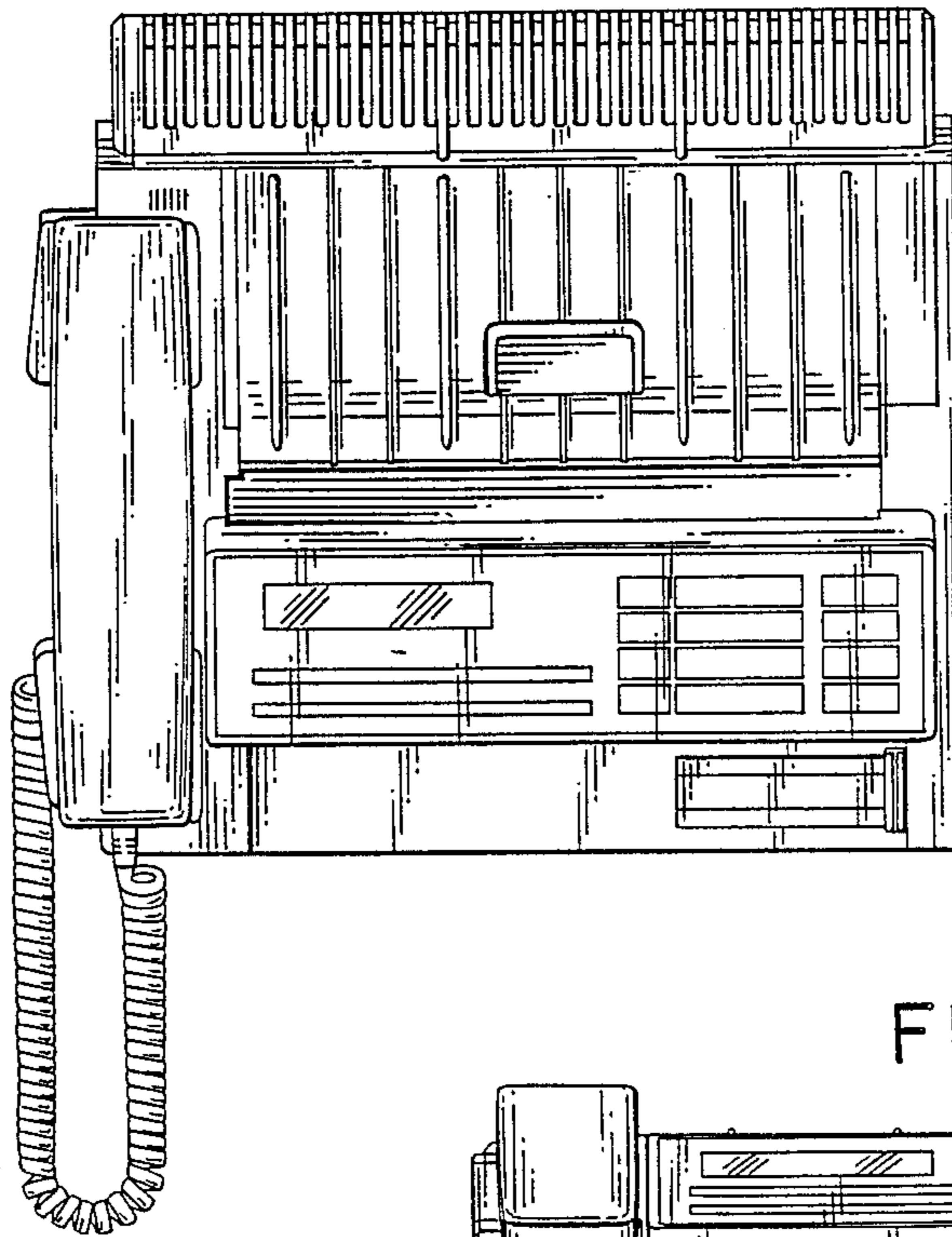

FIG. 3

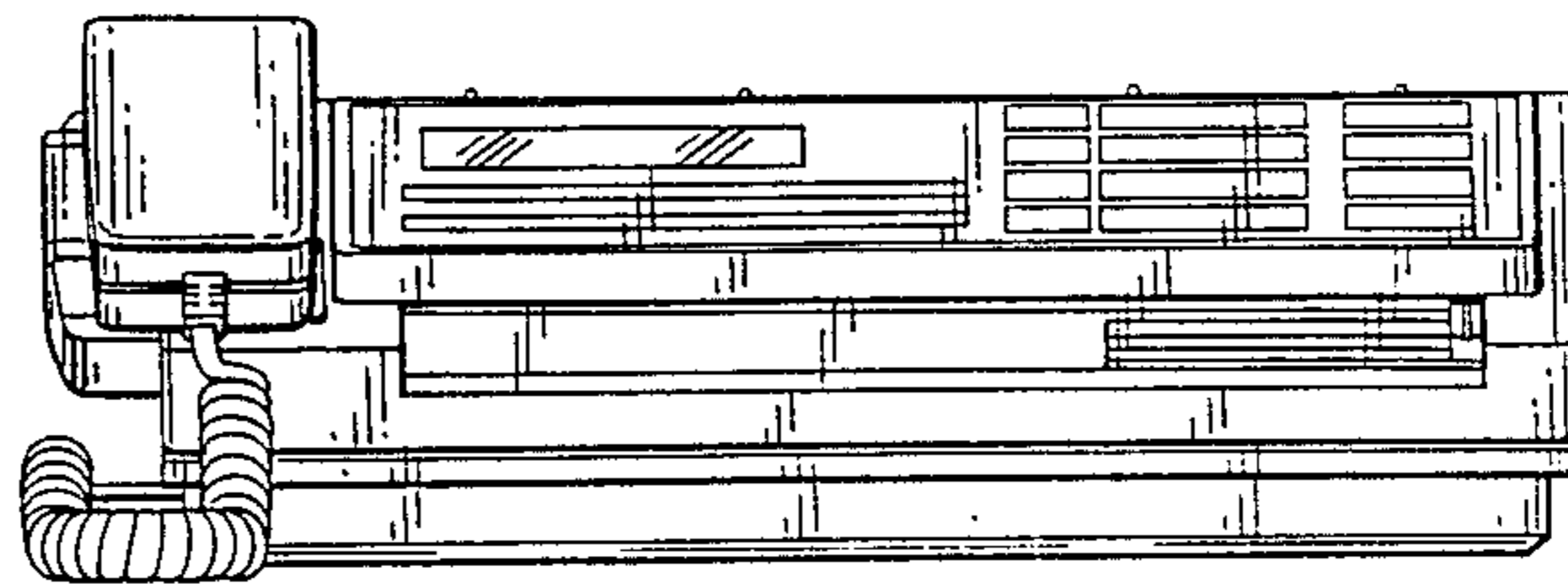

FIG. 4

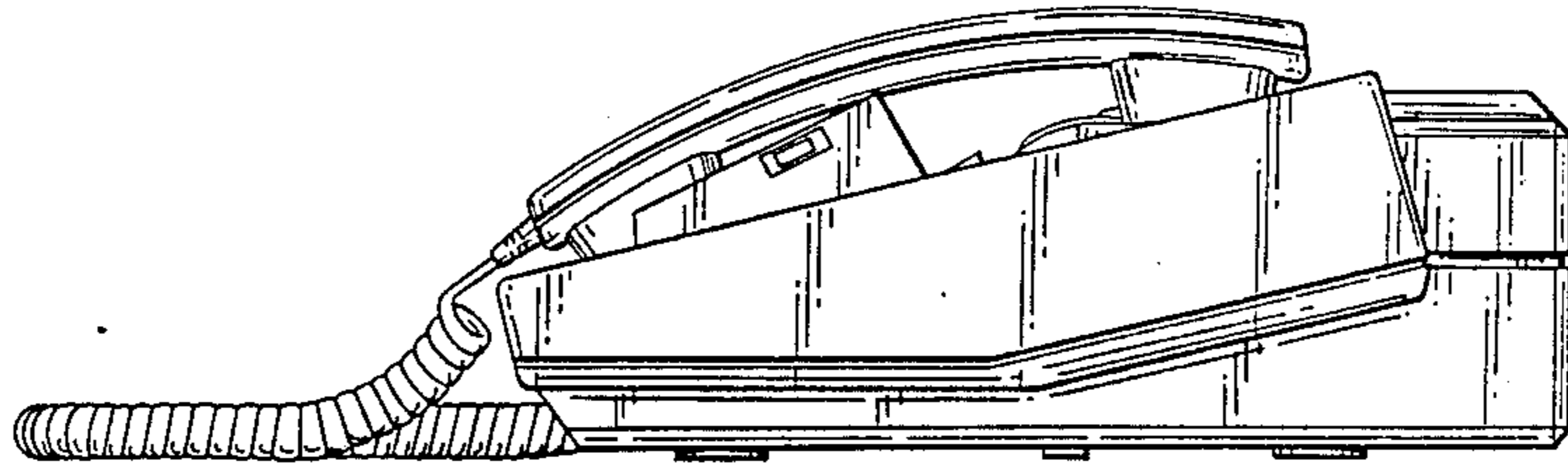

FIG. 5

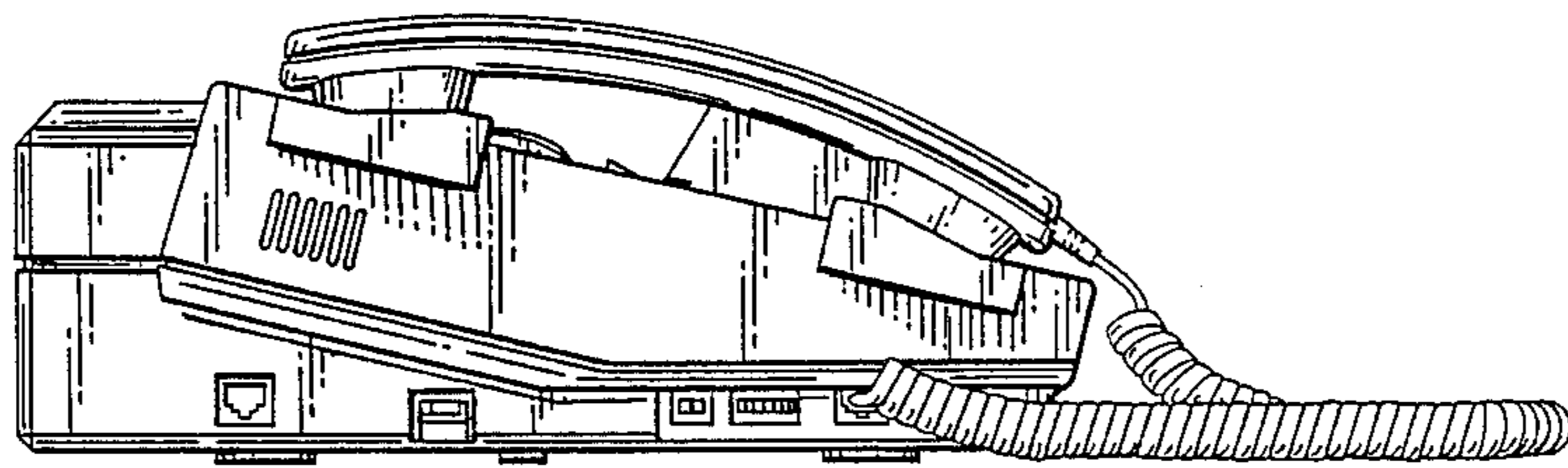

FIG. 6

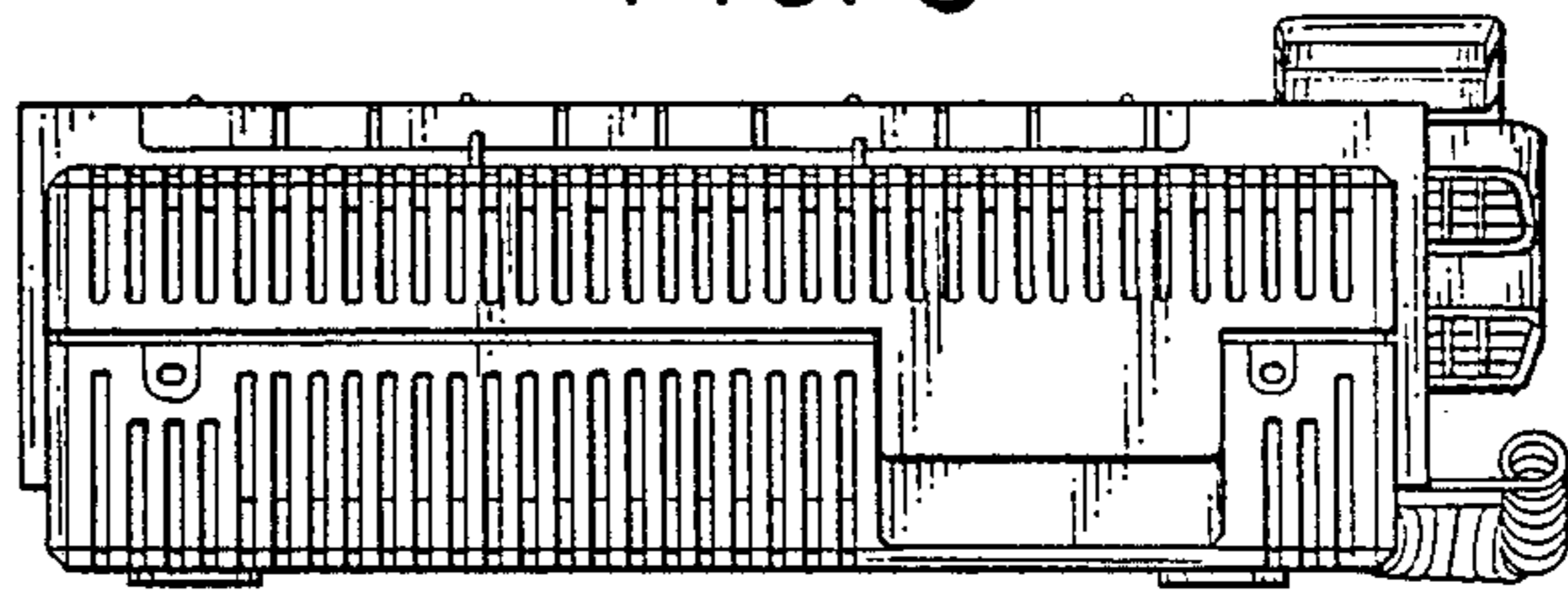

FIG. 7

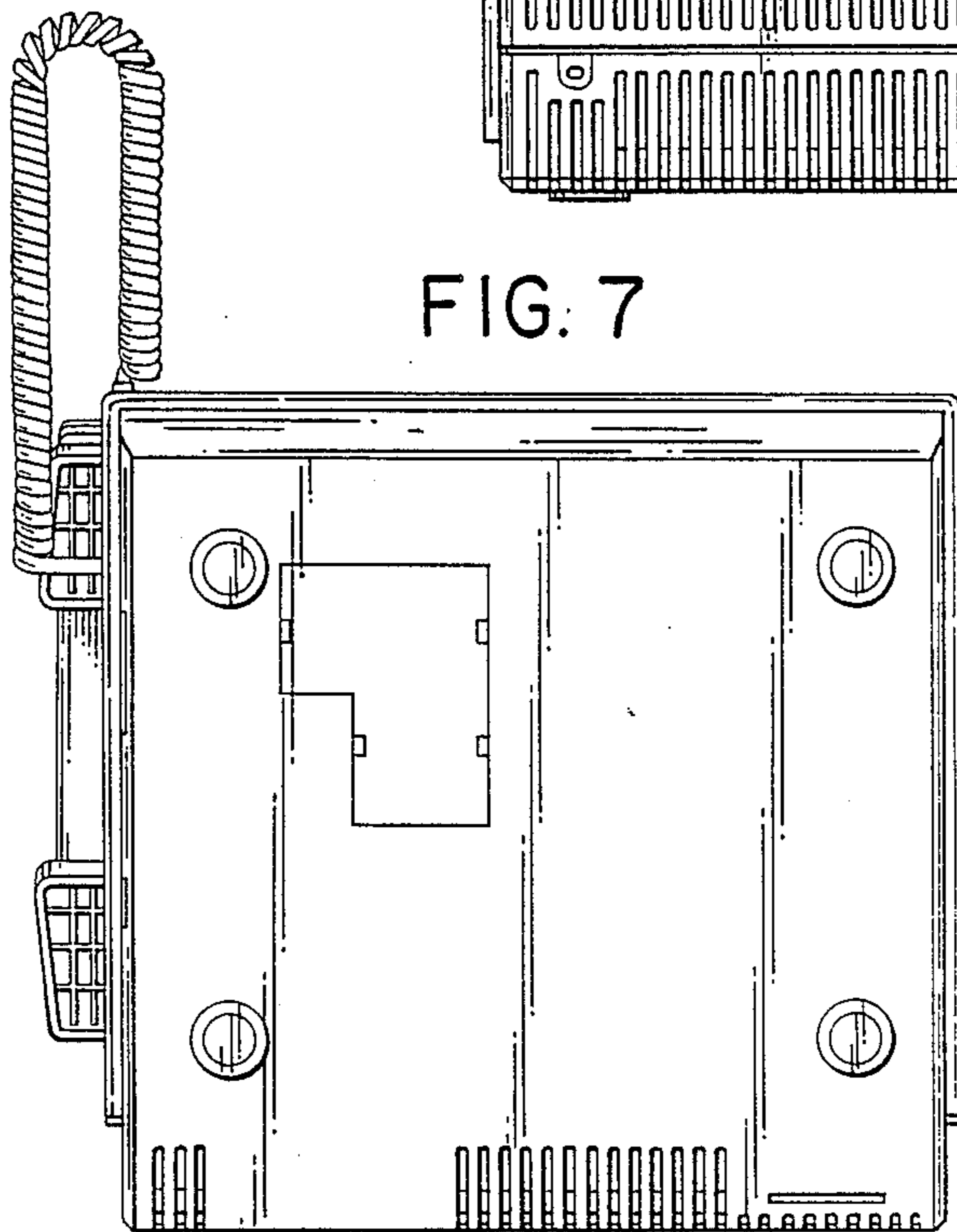

FIG. 8

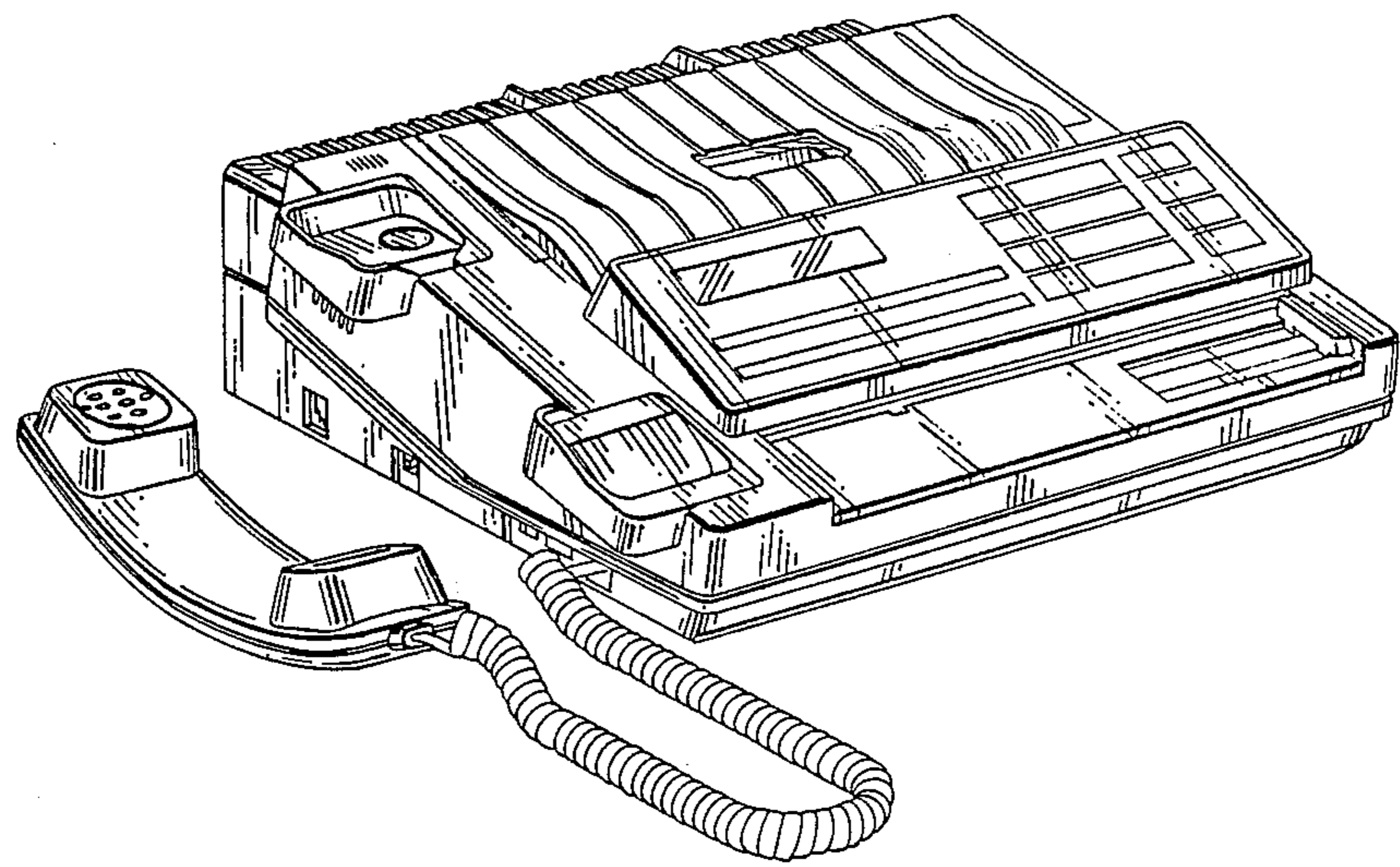

FIG. 9

