

[54] ELECTRIC OVEN TOASTER

[75] Inventors: Kazuo Takada, Nara; Yayoi Ogata, Hyogo; Naomi Nakajima, Kyoto, all of Japan

[73] Assignee: Sanyo Electric Co., Ltd., Japan

[**] Term: 14 Years

[21] Appl. No.: 947,967

[22] Filed: Dec. 30, 1986

[52] U.S. Cl. D7/350

[58] Field of Search D7/348-351; 99/325, 327, 389, 391-393, 402; 219/413-414, 391

[56] References Cited

U.S. PATENT DOCUMENTS

D. 190,609	6/1961	Campbell, III	D7/350
D. 245,470	8/1977	Ernest	D7/350
D. 253,271	10/1979	Rakocy	D7/350
D. 296,858	7/1988	Ooki	D7/350

OTHER PUBLICATIONS

Sharp, Item KZ-20W1(P) "oven", no date. Japanese Patent 603,866, 7/5/1983, "Oven". Japanese Patent 687,715, 9/22/1986, "Oven". Japanese Patent 687,711 9/22/86, "Oven".

Primary Examiner—Bruce W. Dunkins
Assistant Examiner—Ruth Takemoto
Attorney, Agent, or Firm—Darby & Darby

[57] CLAIM

The ornamental design for an electric oven toaster, as shown and described.

DESCRIPTION

FIG. 1 is a front perspective view of an electric oven toaster showing our new design;
FIG. 2 is a front perspective view thereof in an open position;
FIG. 3 is a front elevational view thereof;
FIG. 4 is a rear elevational view thereof;
FIG. 5 is a top plan view thereof;
FIG. 6 is a bottom plan view thereof;
FIG. 7 is a left side elevational view thereof; and
FIG. 8 is a right side elevational view thereof.

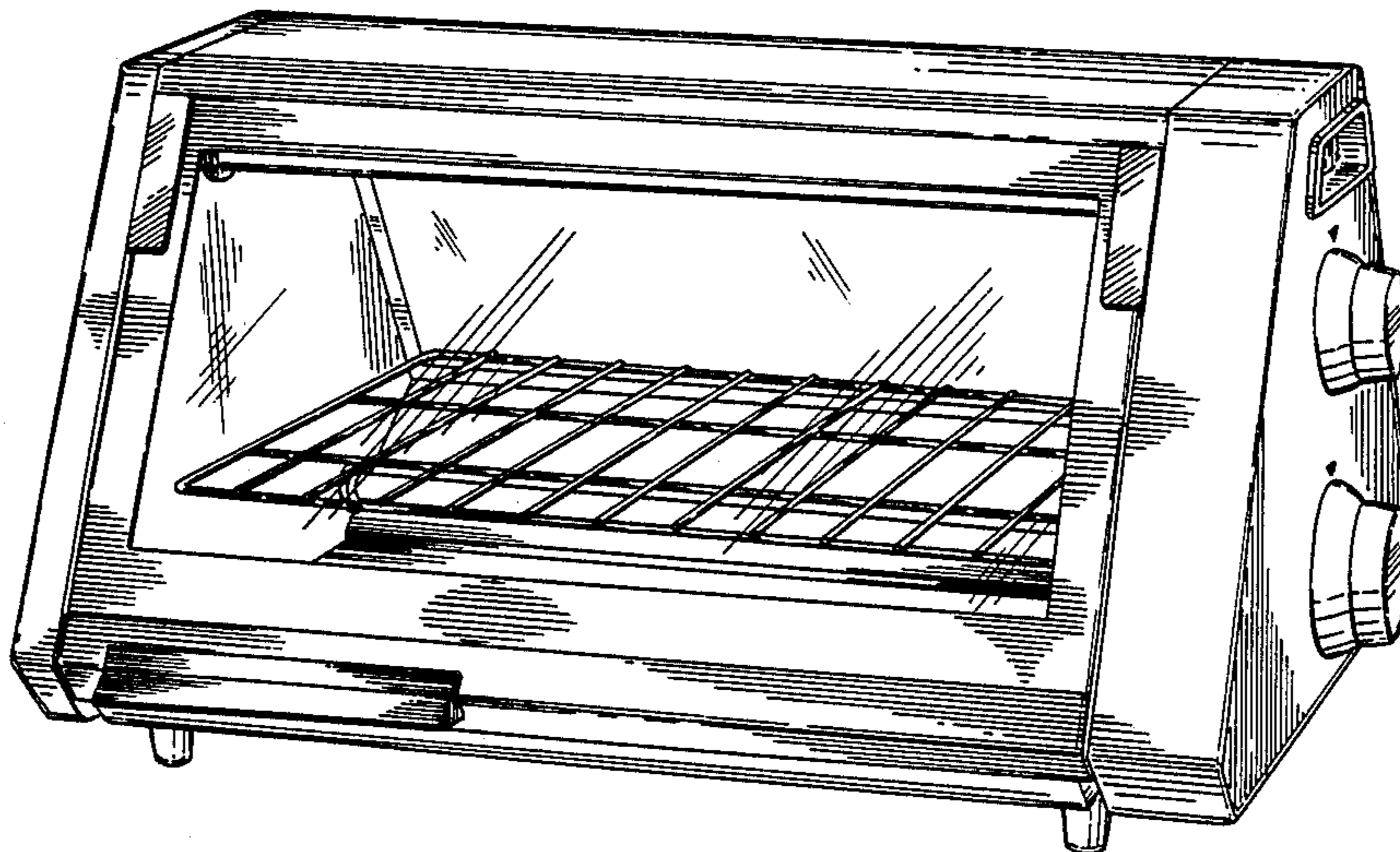

FIG. 1

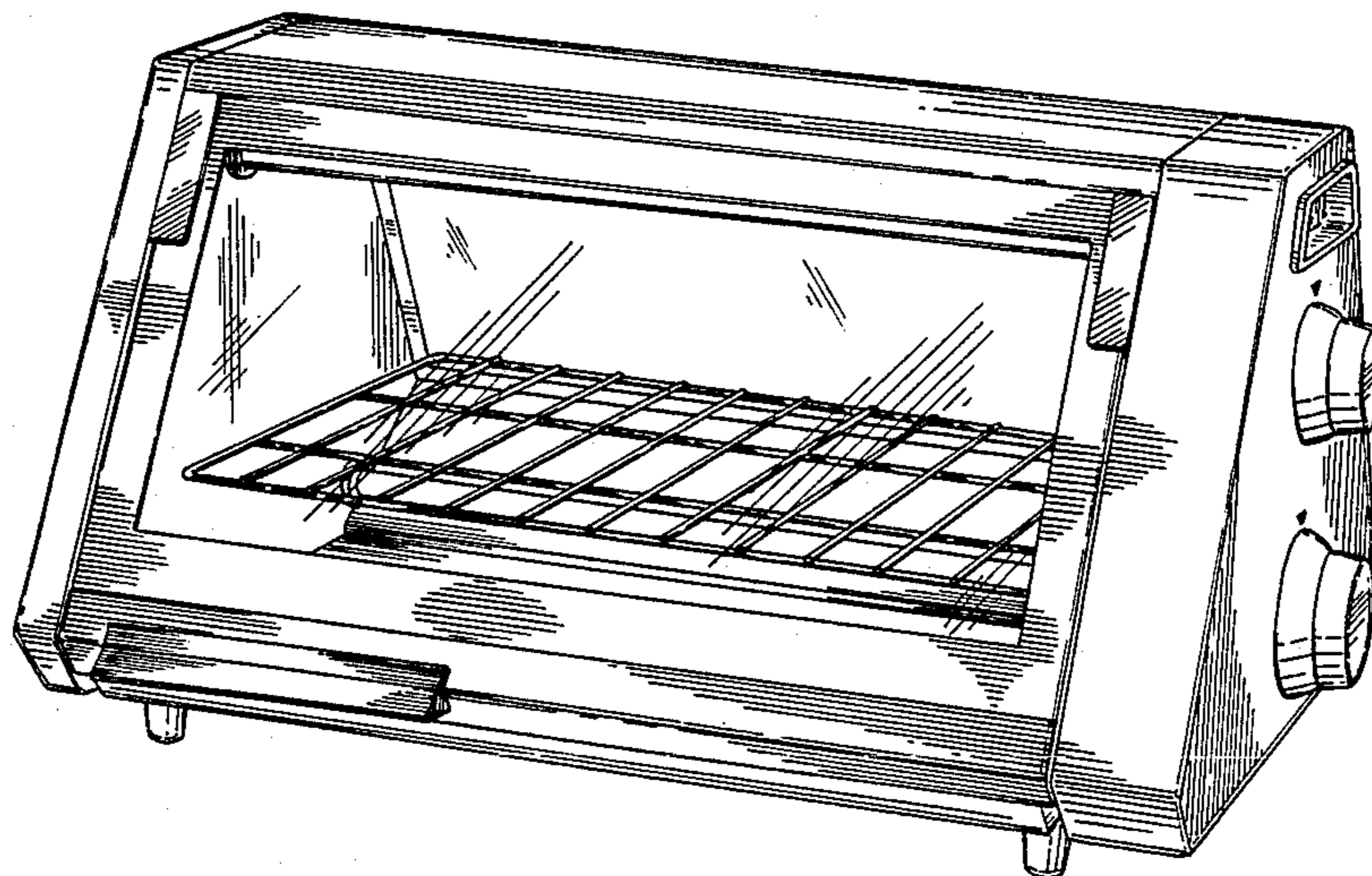

FIG. 2

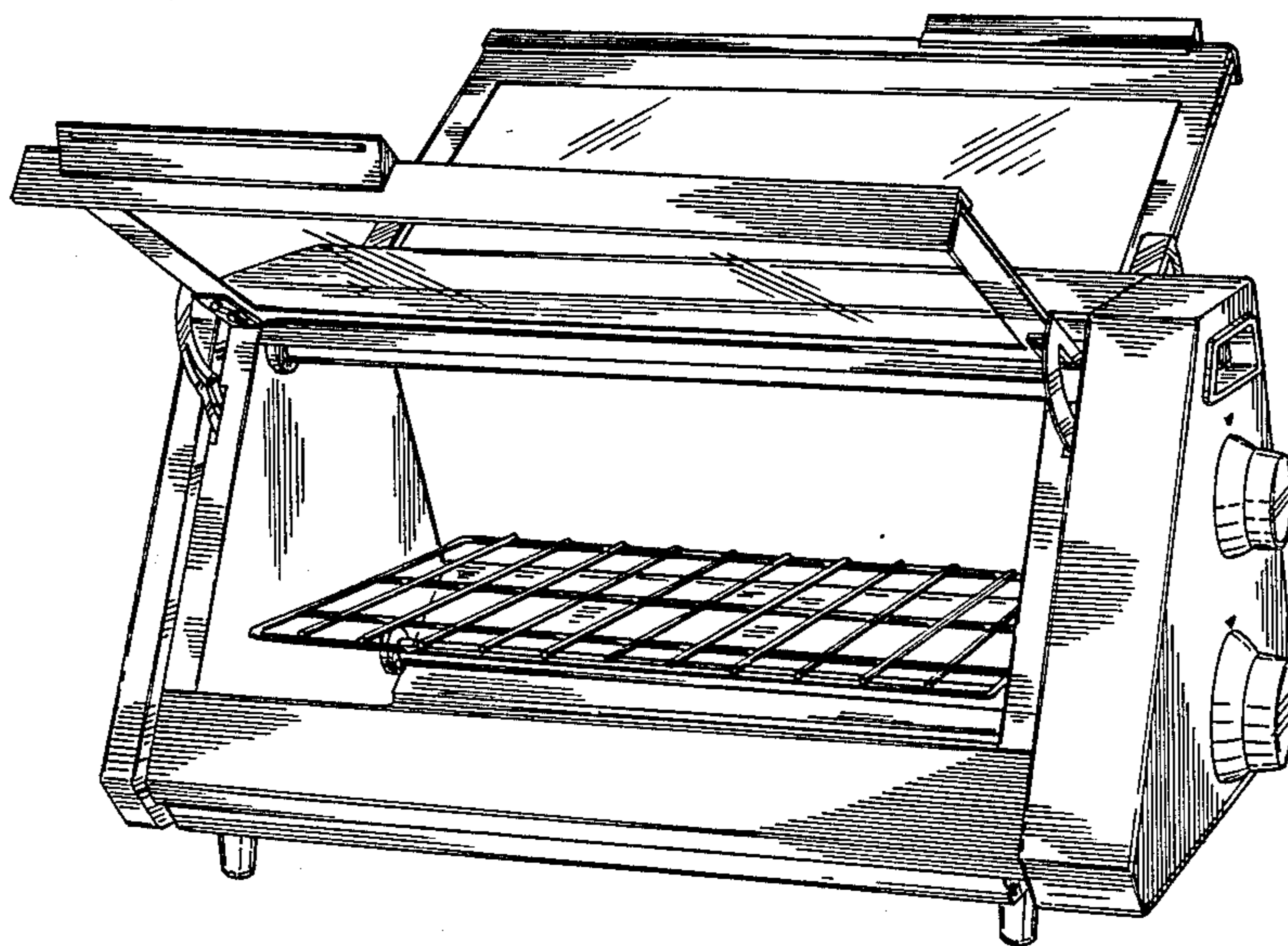

FIG. 3

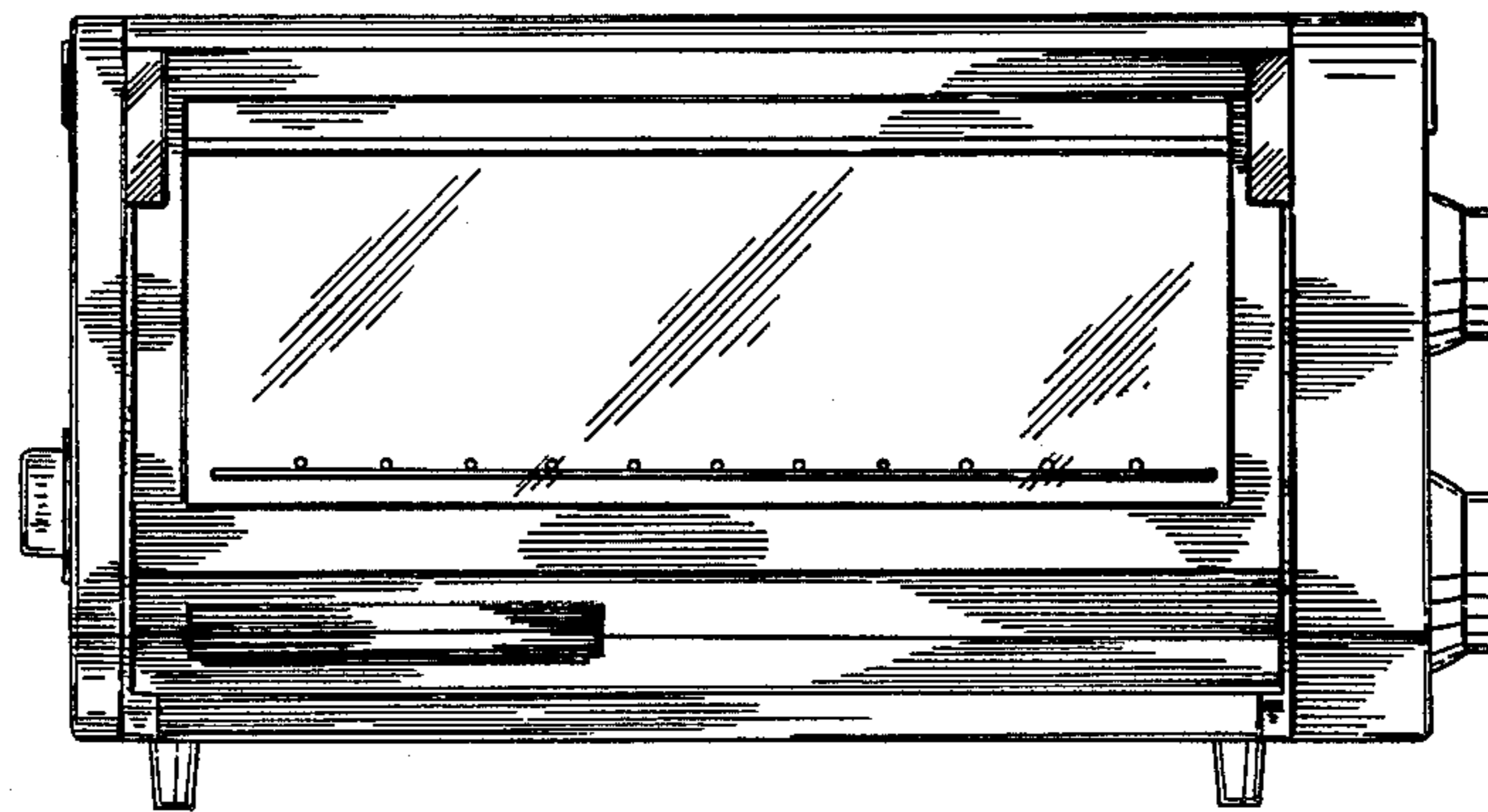

FIG. 4

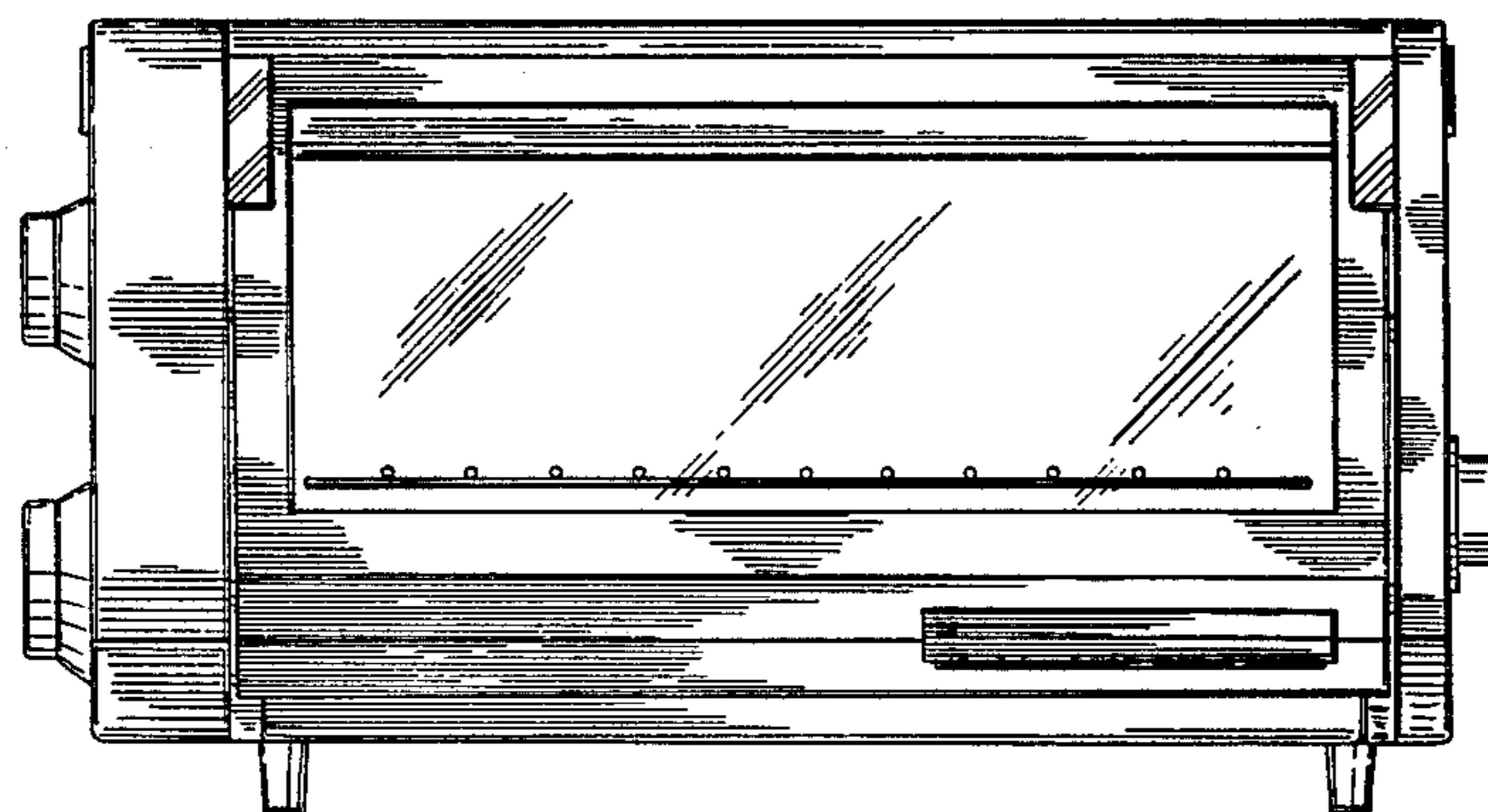

FIG. 5

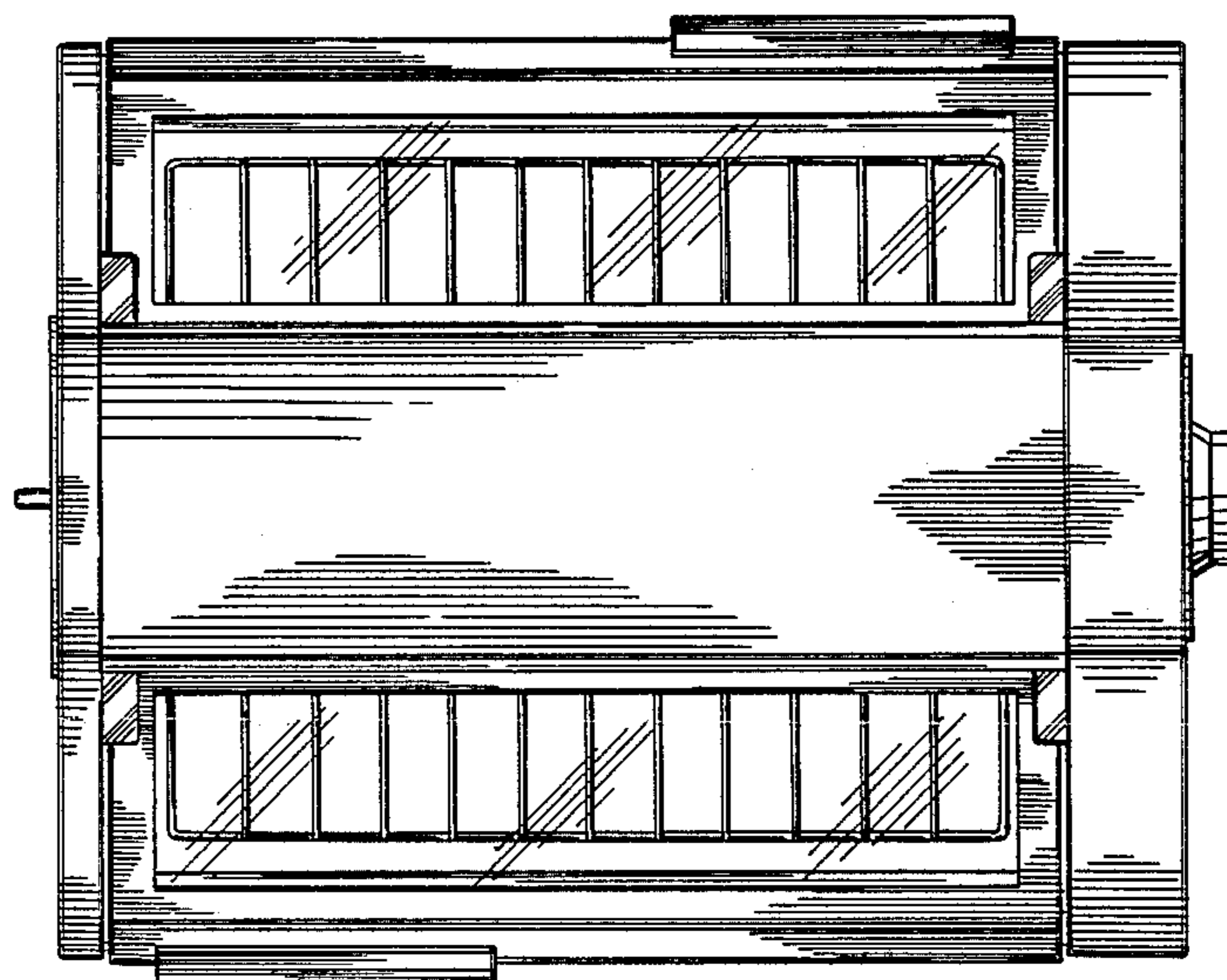

FIG. 6

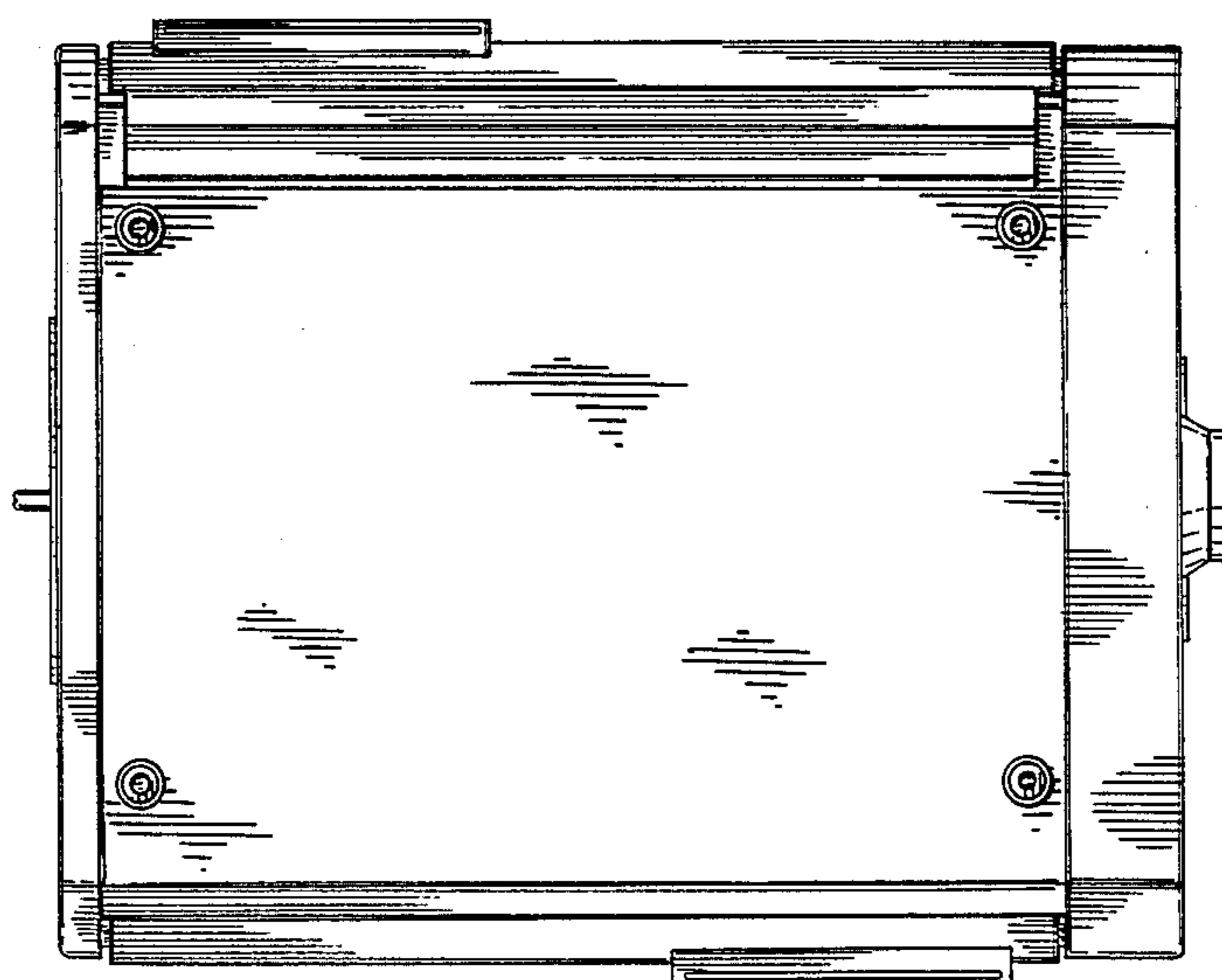

FIG. 7

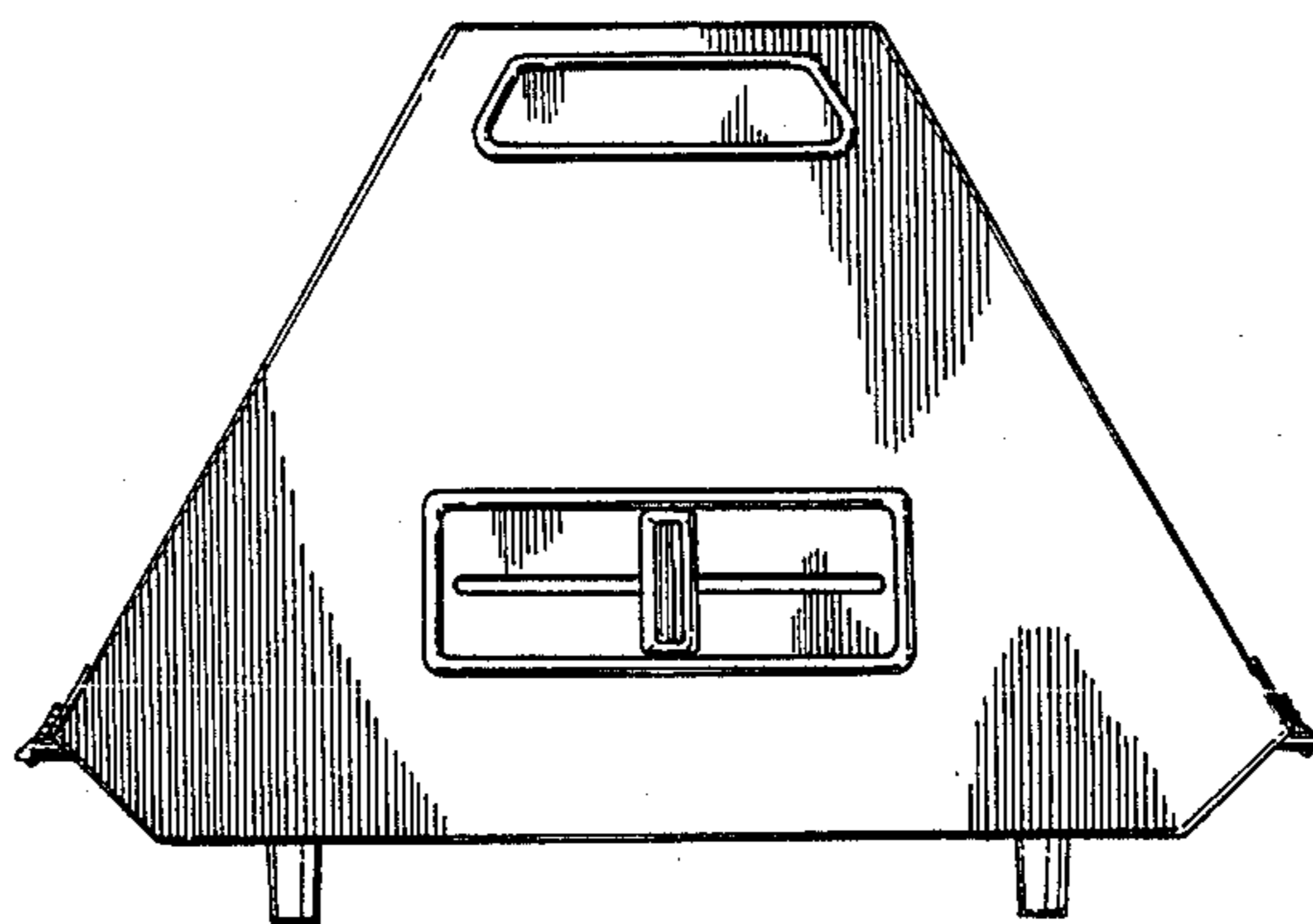

FIG. 8

