

[54] **TOP SHELF FOR A MODULAR CART**

[75] **Inventor: Robert J. Cohn, Dallas, Pa.**

[73] **Assignee: InterMetro Industries Corporation, Wilkes-Barre, Pa.**

[**] **Term: 14 Years**

[21] **Appl. No.: 98,030**

[22] **Filed: Sep. 18, 1987**

[52] **U.S. Cl. D34/27; D34/12**

[58] **Field of Search D6/512, 553, 567, 574; D24/31; D7/19, 21; 108/28, 136; 211/13, 16, 86, 88-90, 126, 134; D34/12, 40, 43, 20-21, 27**

[56] **References Cited**

U.S. PATENT DOCUMENTS

D. 265,615	8/1982	Virte et al.	D6/574
D. 283,478	4/1986	Schmidt	D7/19
3,777,673	12/1973	Blazey et al.	108/27
4,595,107	6/1986	Welsch	211/181 X
4,620,637	11/1986	Karashima	211/126 X

Primary Examiner—Wallace R. Burke
Assistant Examiner—Brian N. Vinson
Attorney, Agent, or Firm—Fitzpatrick, Cella, Harper & Scinto

[57] **CLAIM**

The ornamental design for a top shelf for a modular cart, as shown and described.

DESCRIPTION

FIG. 1 is a perspective view of a top shelf for a modular cart showing my new design;
FIG. 2 is a top plan view thereof;
FIG. 3 is a front elevational view thereof;
FIG. 4 is a rear elevational view thereof;
FIG. 5 is a right side elevational view thereof;
FIG. 6 is a left side elevational view thereof;
FIG. 7 is a bottom plan view thereof;
FIG. 8 is a vertical cross-sectional view thereof, taken along line 8—8 of FIG. 2;
FIG. 9 is a top plan view of an alternate embodiment thereof;
FIG. 10 is a front elevational view of the embodiment of FIG. 9;
FIG. 11 is a rear elevational view of the embodiment of FIG. 9;
FIG. 12 is a right side elevational view of the embodiment of FIG. 9;
FIG. 13 is a left side elevational view of the embodiment of FIG. 9;
FIG. 14 is a bottom plan view of the embodiment of FIG. 9; and
FIG. 15 is a vertical cross-sectional view of the embodiment of FIG. 9 taken along line 15—15 of FIG. 9.

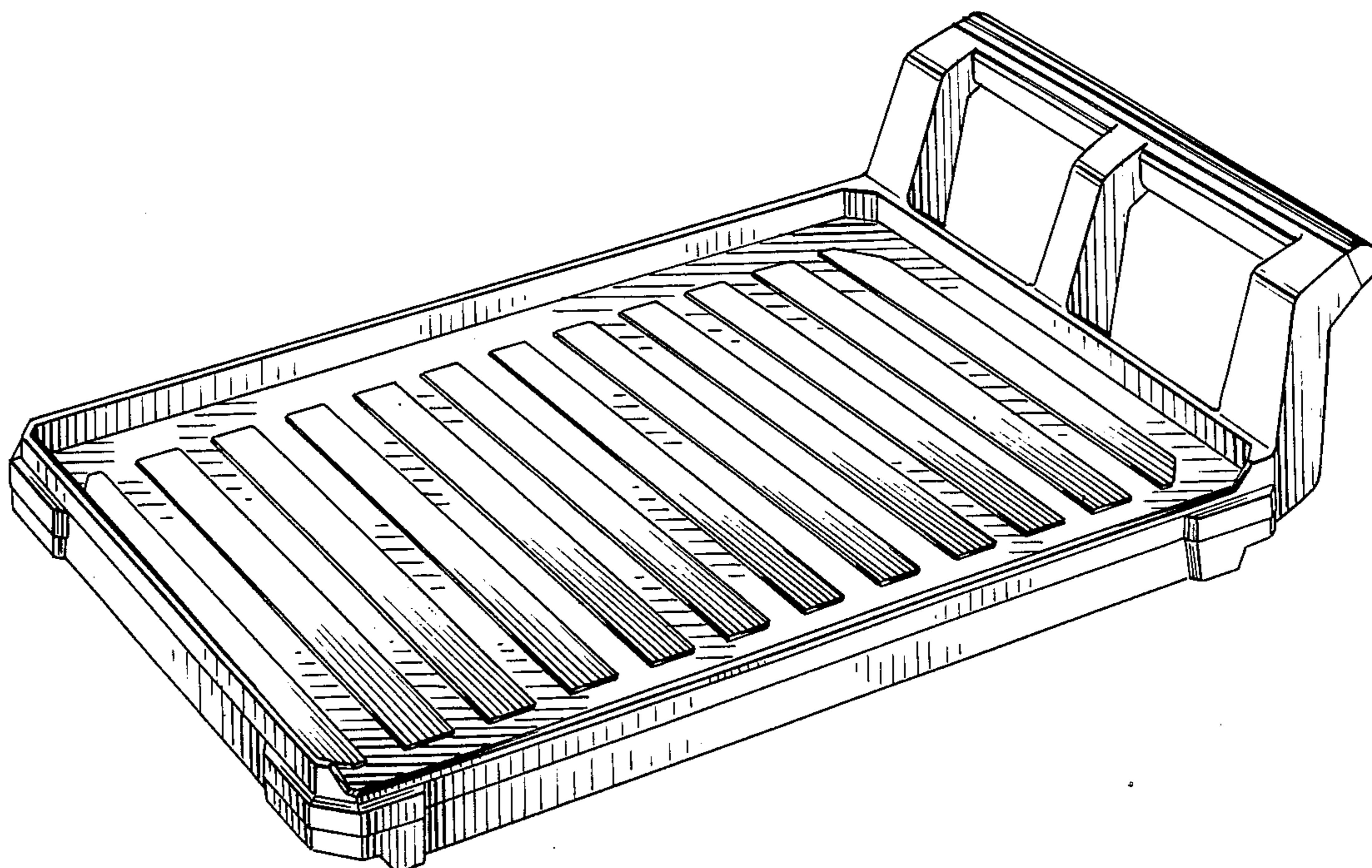

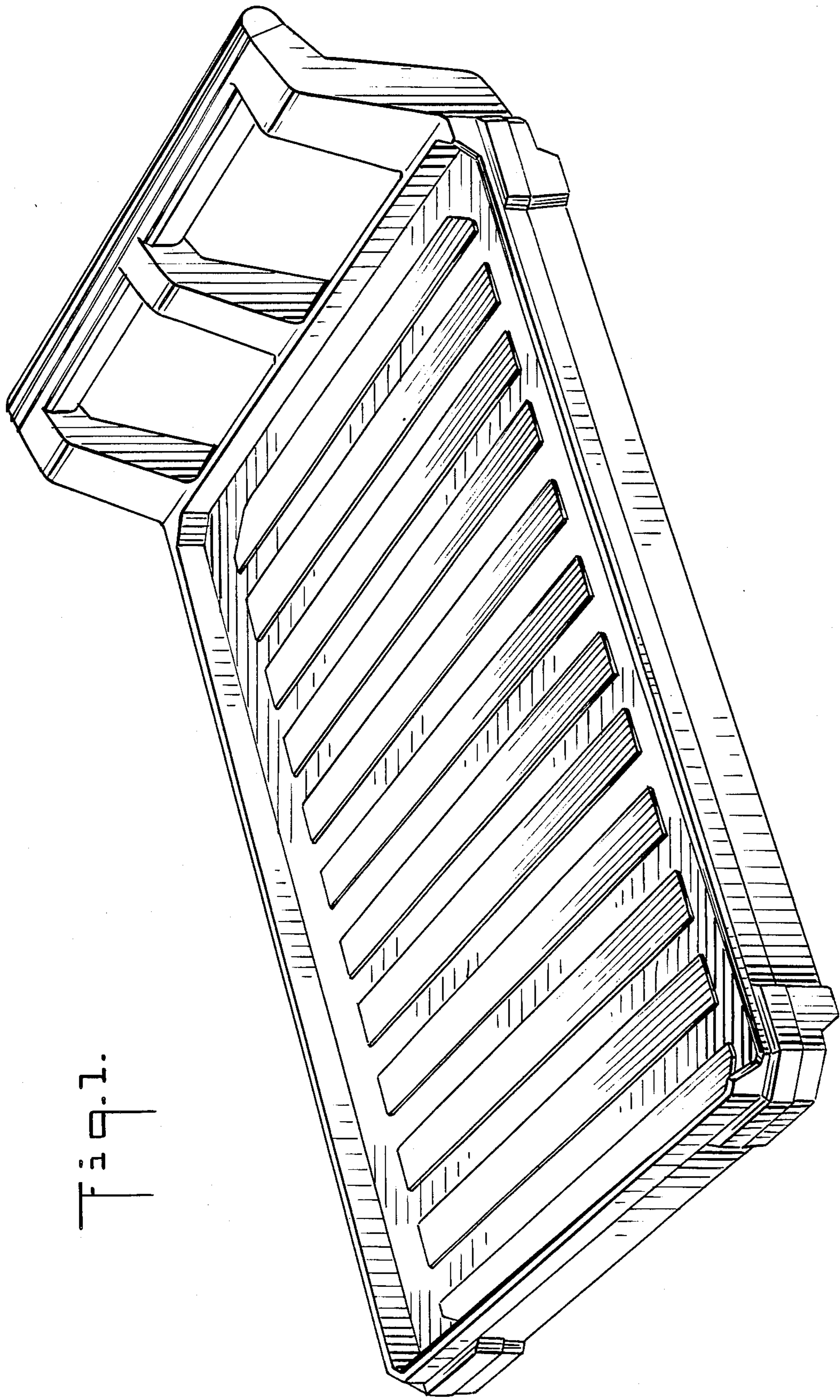

Fig. 1.

0 ←

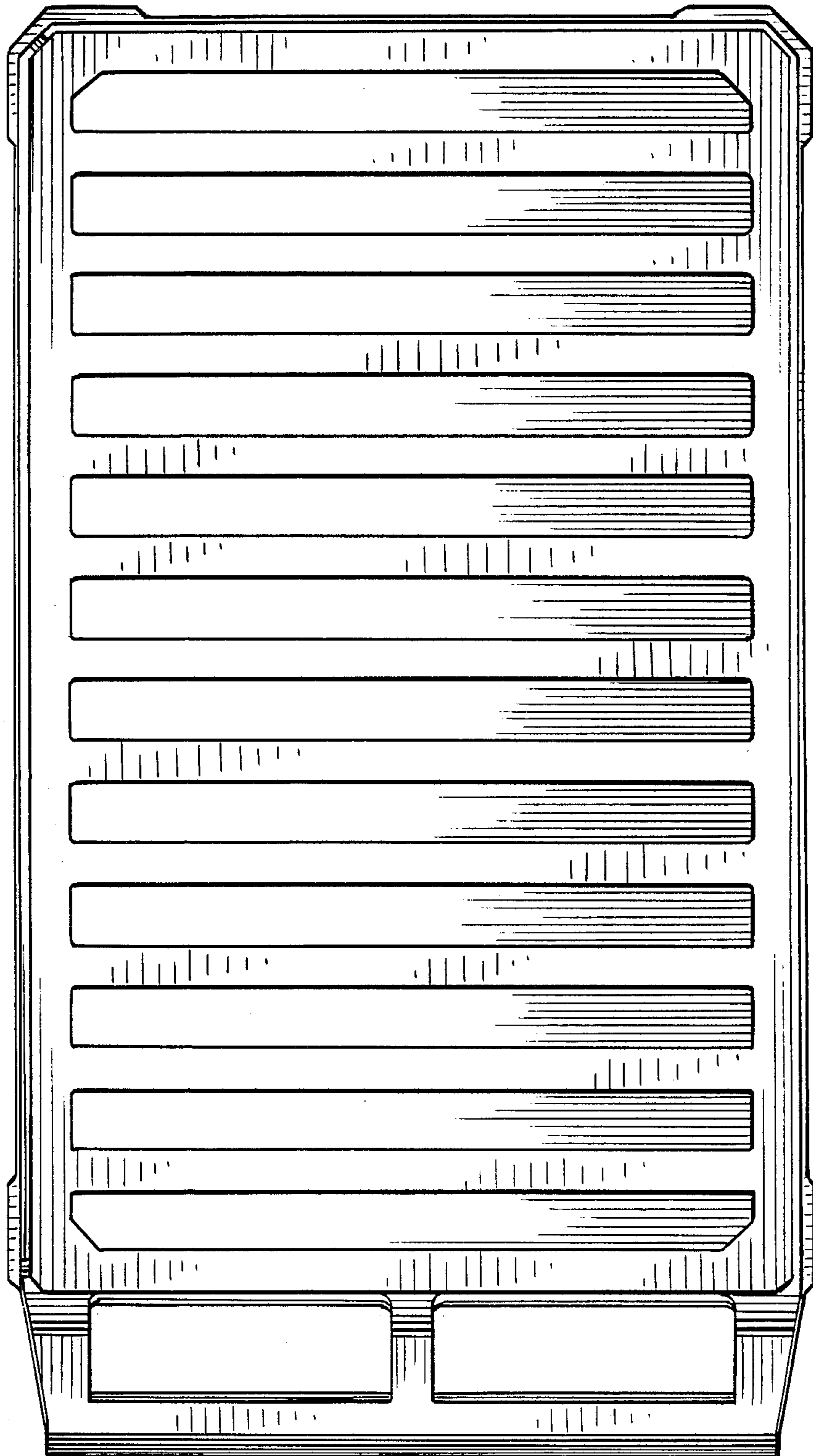

Fig. 2.

0 ←

Fig. 3.

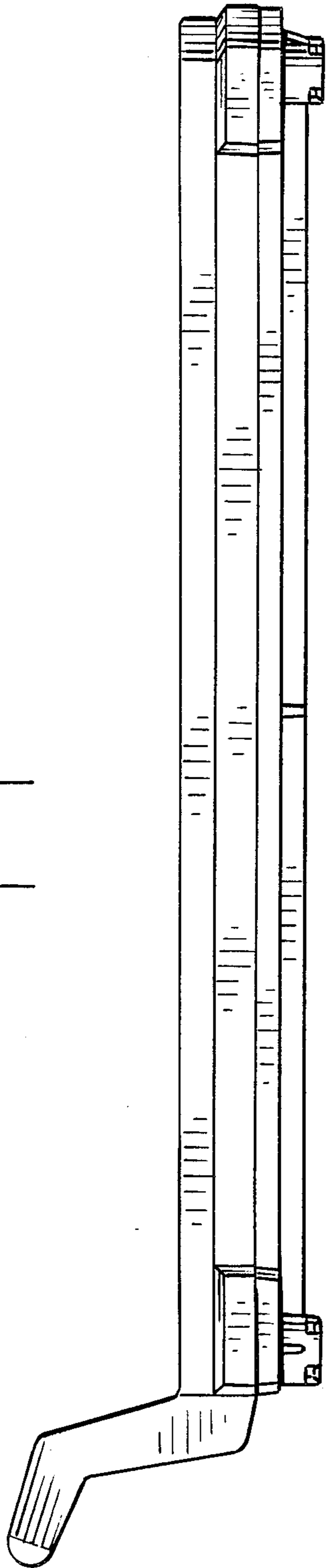
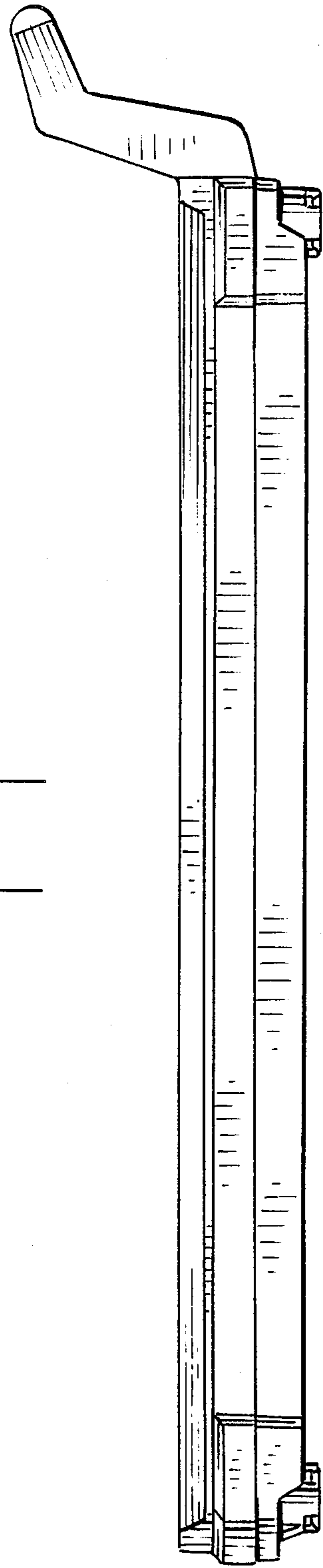

Fig. 4.



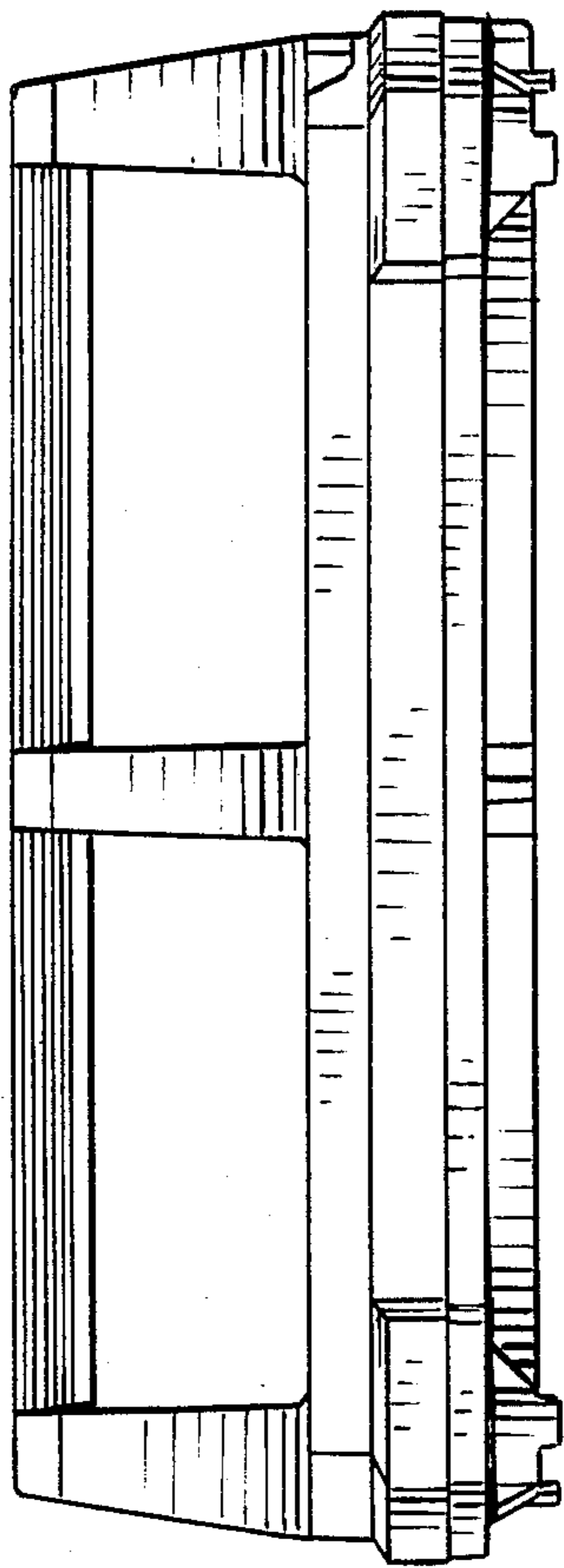

Fig. 5.

Fig. 6.

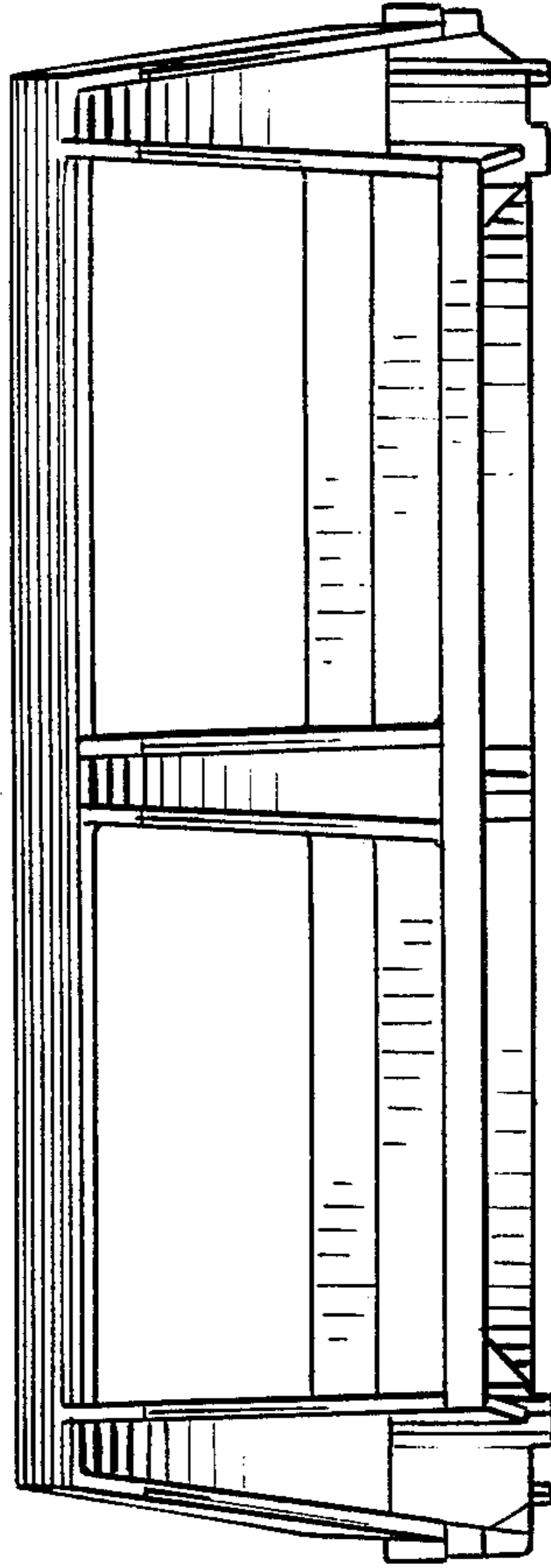

Fig. 6.

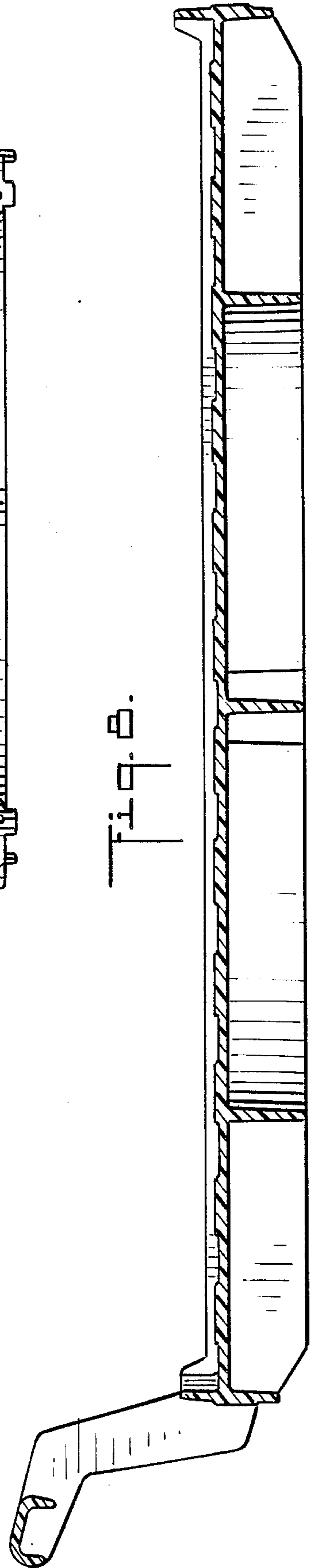

Fig. 2.

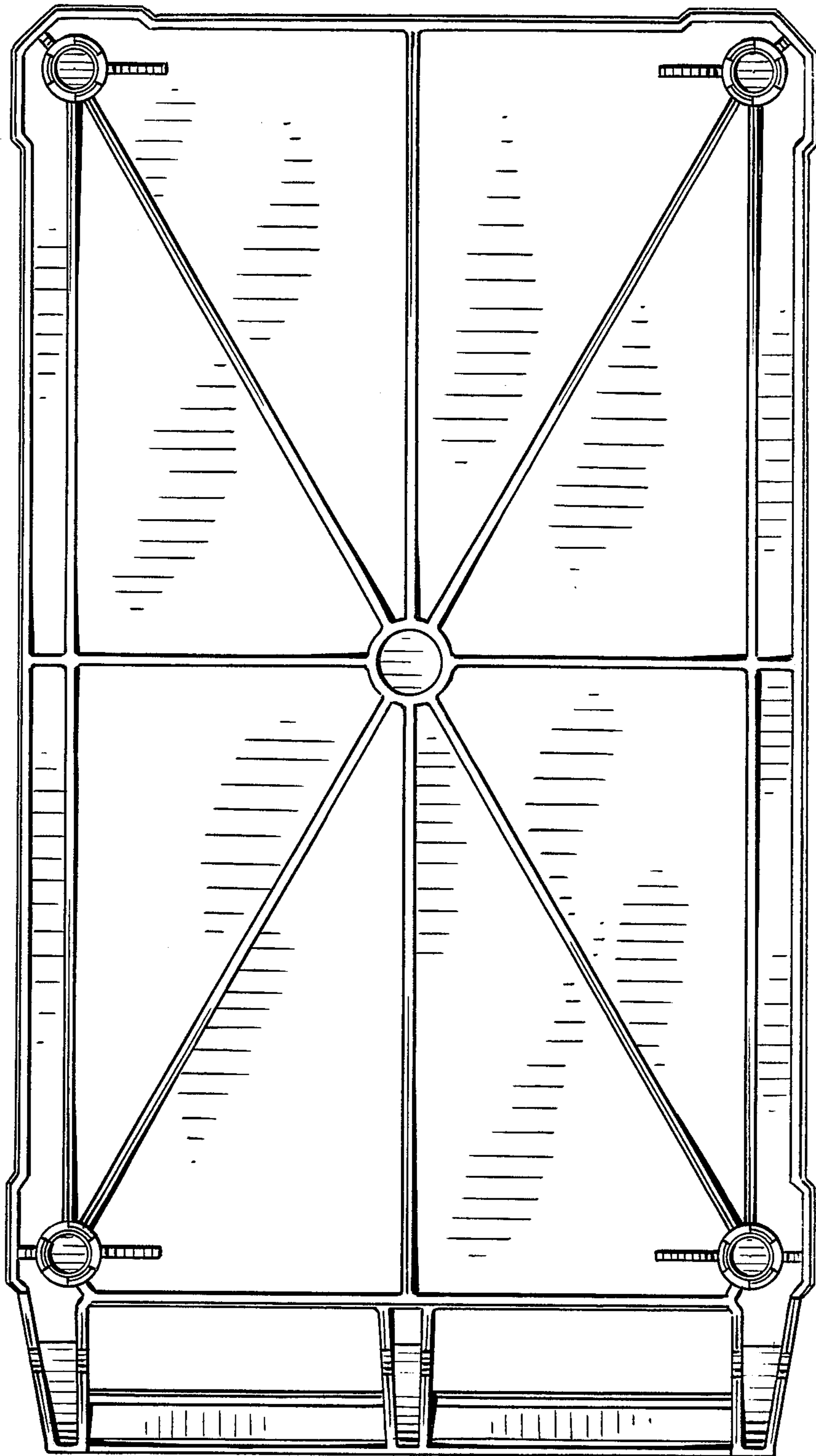

Fig. 9.

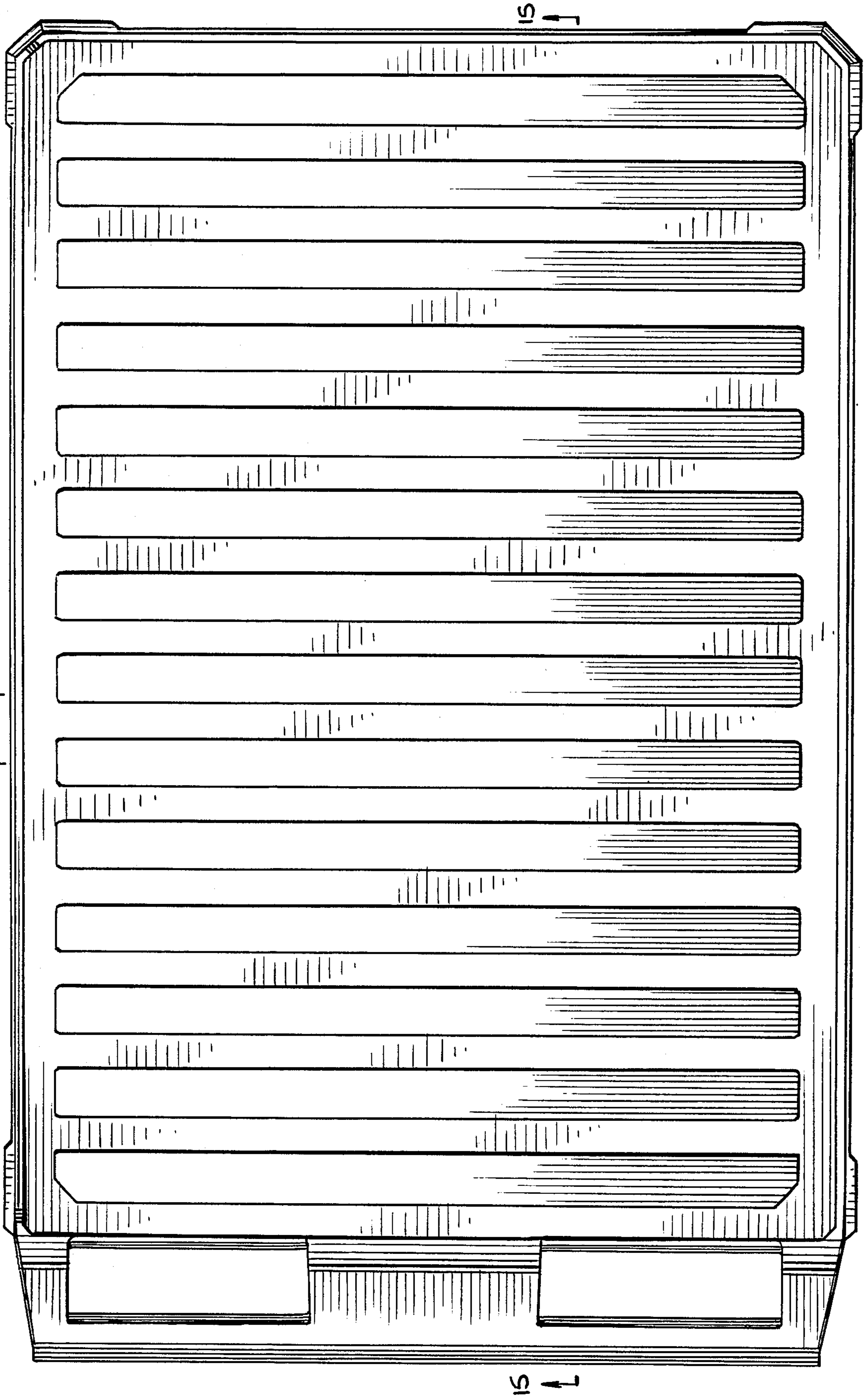

Fig. 10.

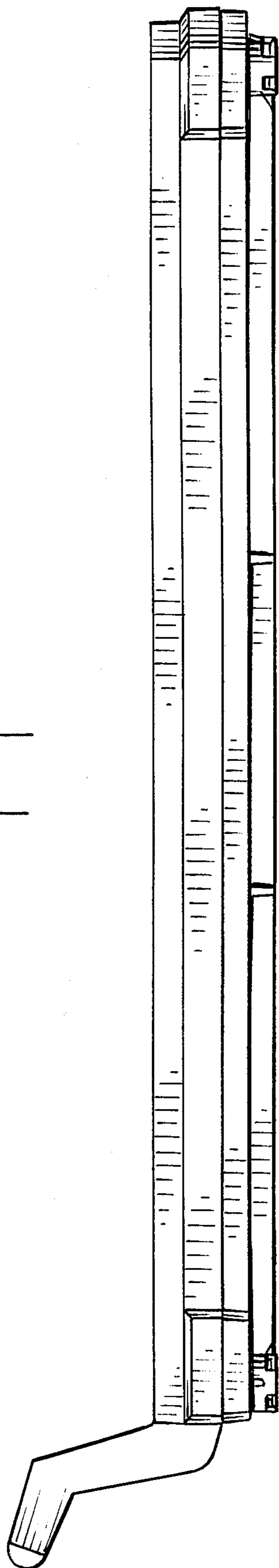

Fig. 11.

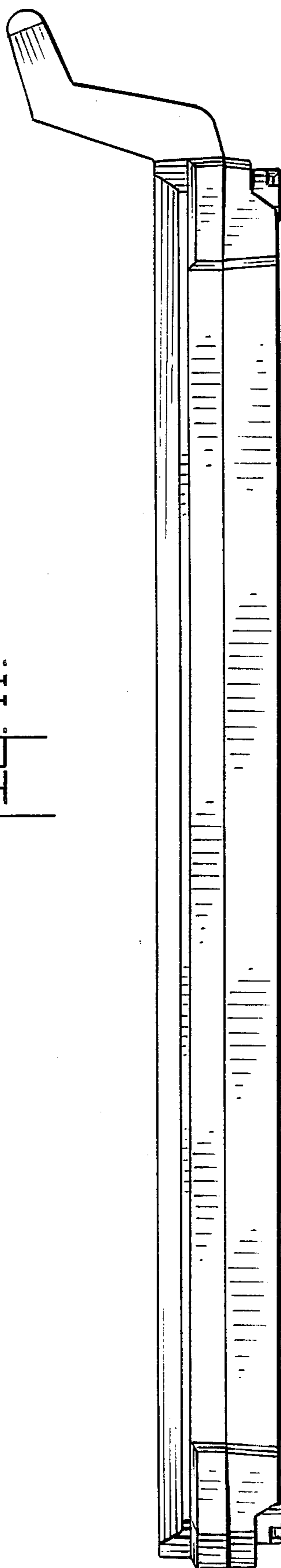

Fig. 12.

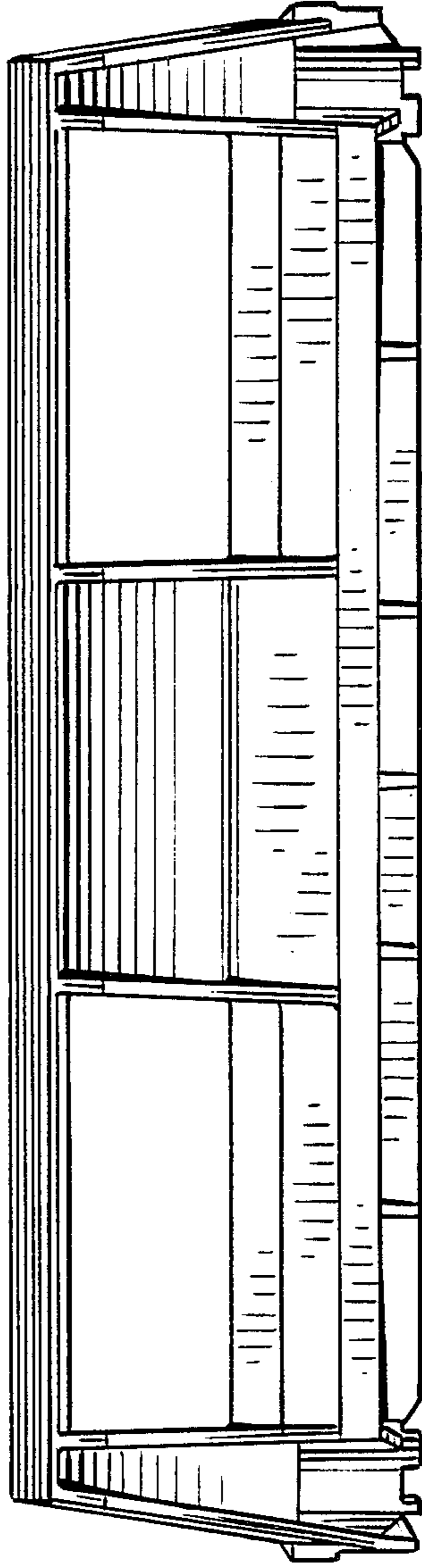
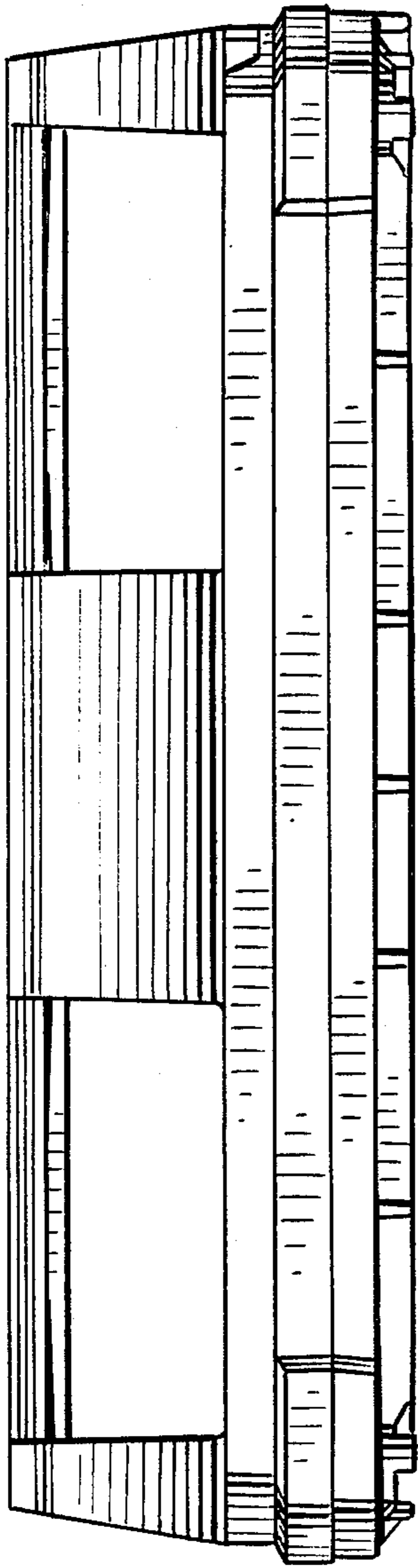

Fig. 13.

Fig. 15.

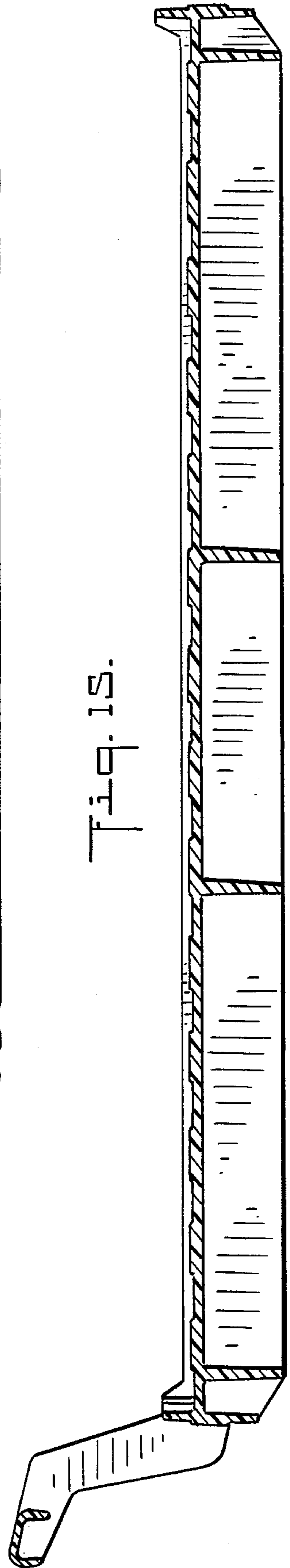
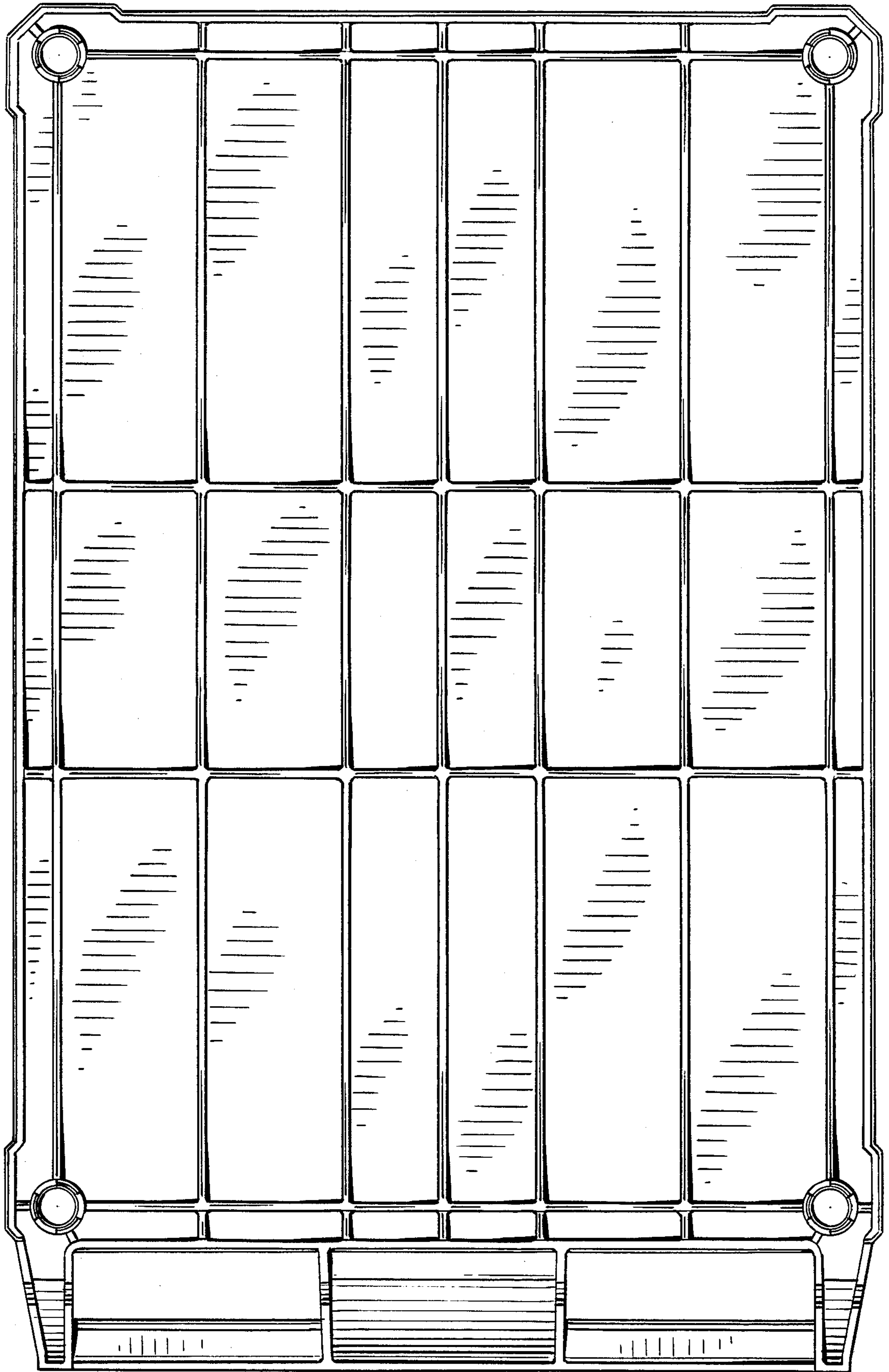

Fig. 14.



UNITED STATES PATENT AND TRADEMARK OFFICE
CERTIFICATE OF CORRECTION

PATENT NO. : Des. 304,115
DATED : October 17, 1989
INVENTOR(S) : ROBERT J. COHN

It is certified that error appears in the above-identified patent and that said Letters Patent is hereby corrected as shown below:

AT [57] CLAIM

"ornamental" should read --ornamental--.

Signed and Sealed this
Twenty-eighth Day of May, 1991

Attest:

HARRY F. MANBECK, JR.

Attesting Officer

Commissioner of Patents and Trademarks