

United States Patent [19]

Noggle

[11] Patent Number: Des. 304,107

[45] Date of Patent: ** Oct. 17, 1989

[54] DUSTPAN

[76] Inventor: Donald R. Noggle, 329 Bay St., Harbor Springs, Mich. 49740

[**] Term: 14 Years

[21] Appl. No.: 23,472

[22] Filed: Mar. 6, 1987

[52] U.S. Cl. D32/74

[58] Field of Search 32/74; 15/257.1, 257.2, 15/257.3

[56] **References Cited**

U.S. PATENT DOCUMENTS

D. 132,426	5/1942	George	D32/74
626,096	4/1899	Rice	15/157.1
1,683,517	9/1928	Bentley	15/157.1

Primary Examiner—Wallace R. Burke
Assistant Examiner—Lavone D. Tabor
Attorney, Agent, or Firm—John F. Rohe

[57] **CLAIM**

The ornamental design for a dustpan, as shown and described.

DESCRIPTION

FIG. 1 is a perspective view of a dustpan showing my new design;

FIG. 2 is a reduced top plan view thereof;

FIG. 3 is a bottom plan view thereof;

FIG. 4 is a side elevational view thereof, the opposite side being a mirror image;

FIG. 5 is a rear elevational view thereof; and

FIG. 6 is a front elevational view thereof.

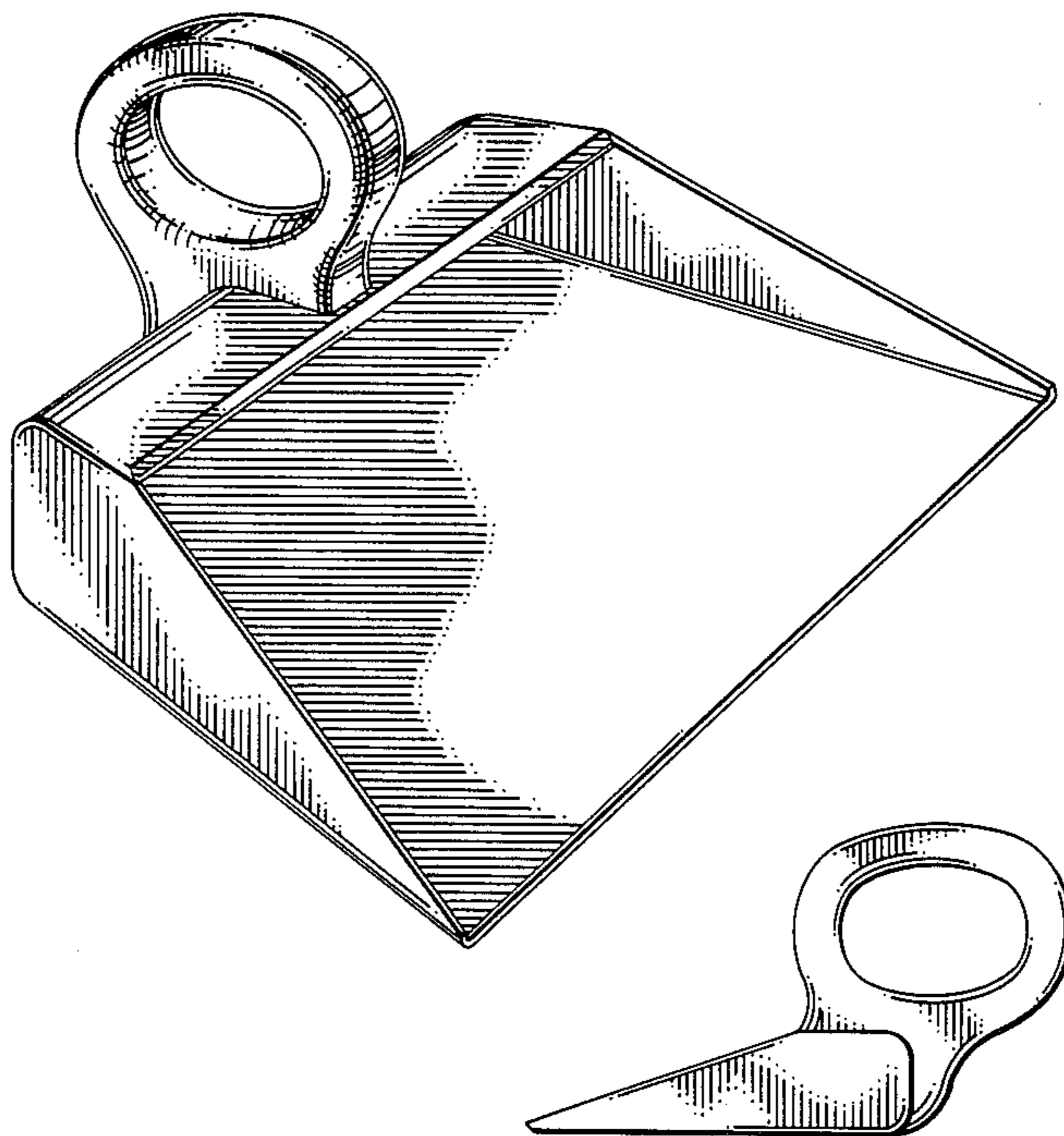

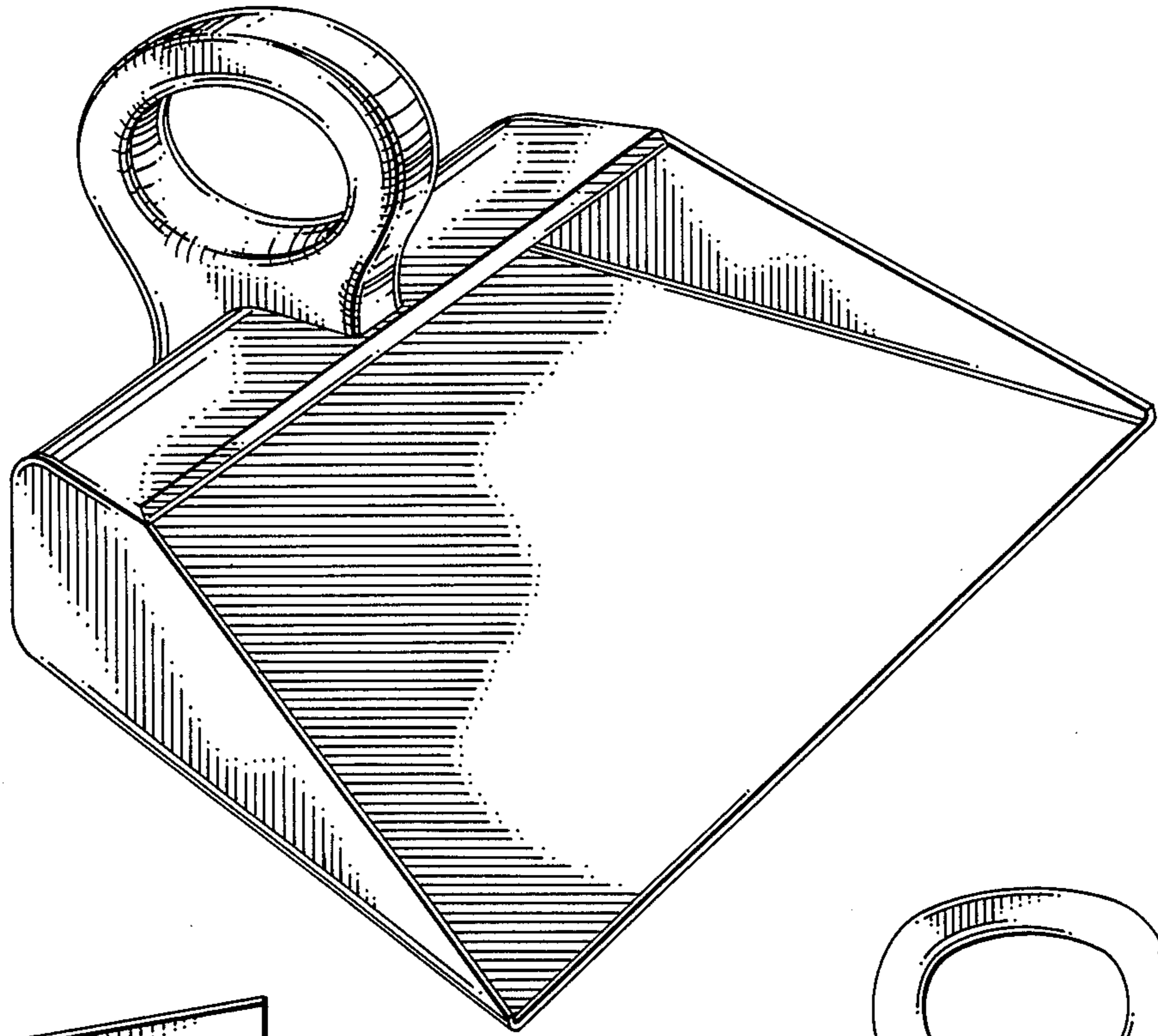

FIG. 1

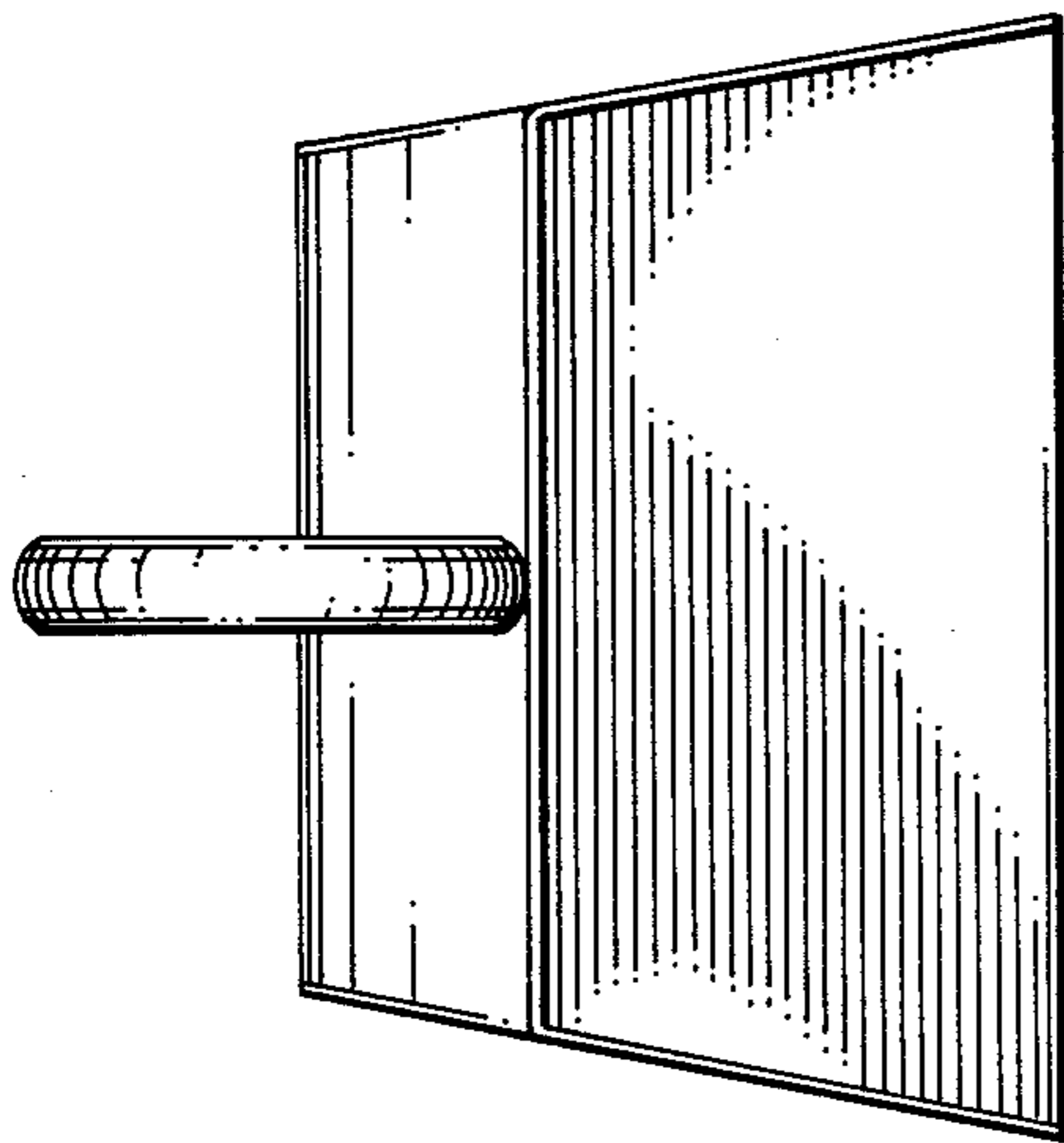

FIG. 2

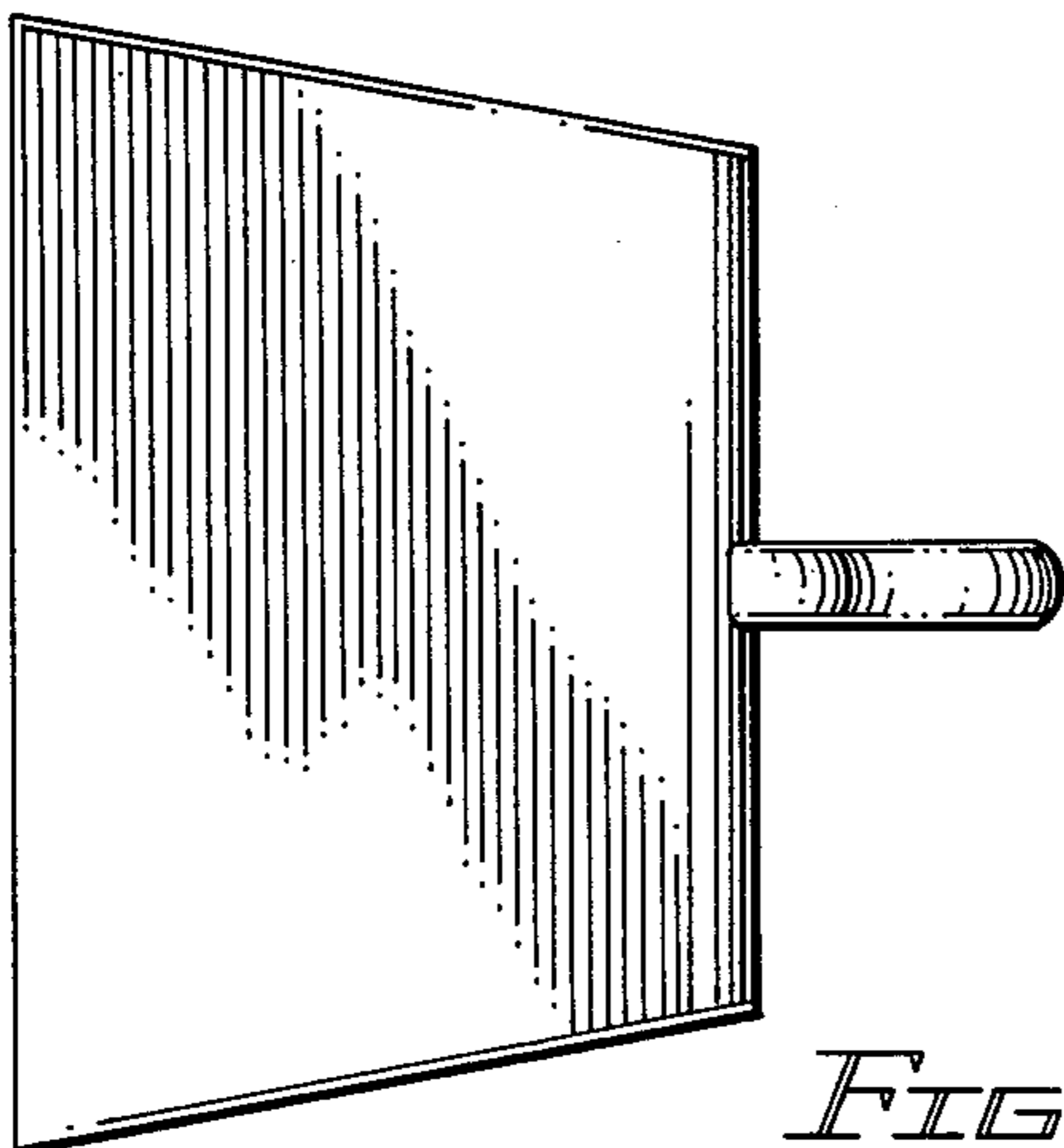

FIG. 3

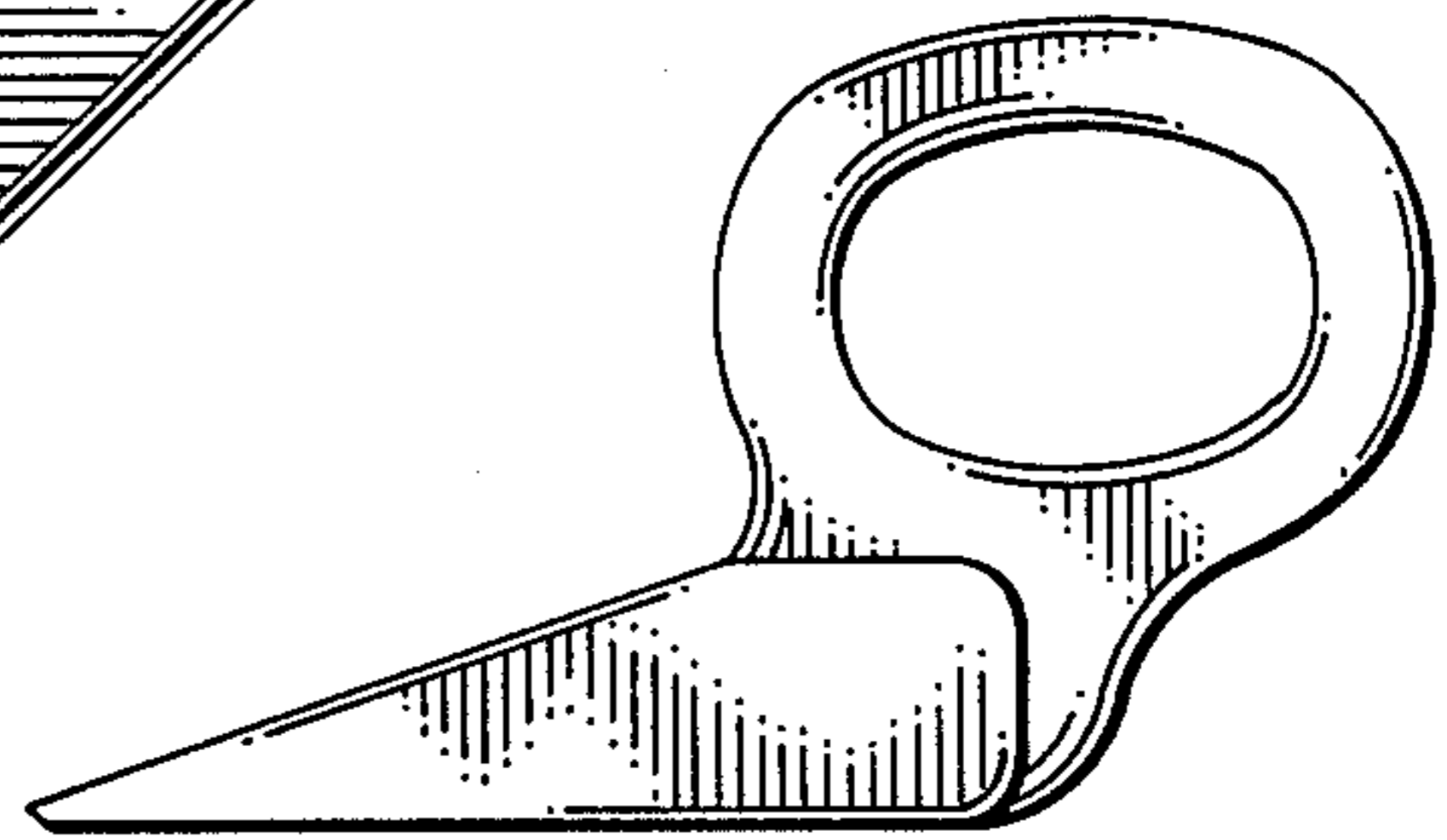

FIG. 4

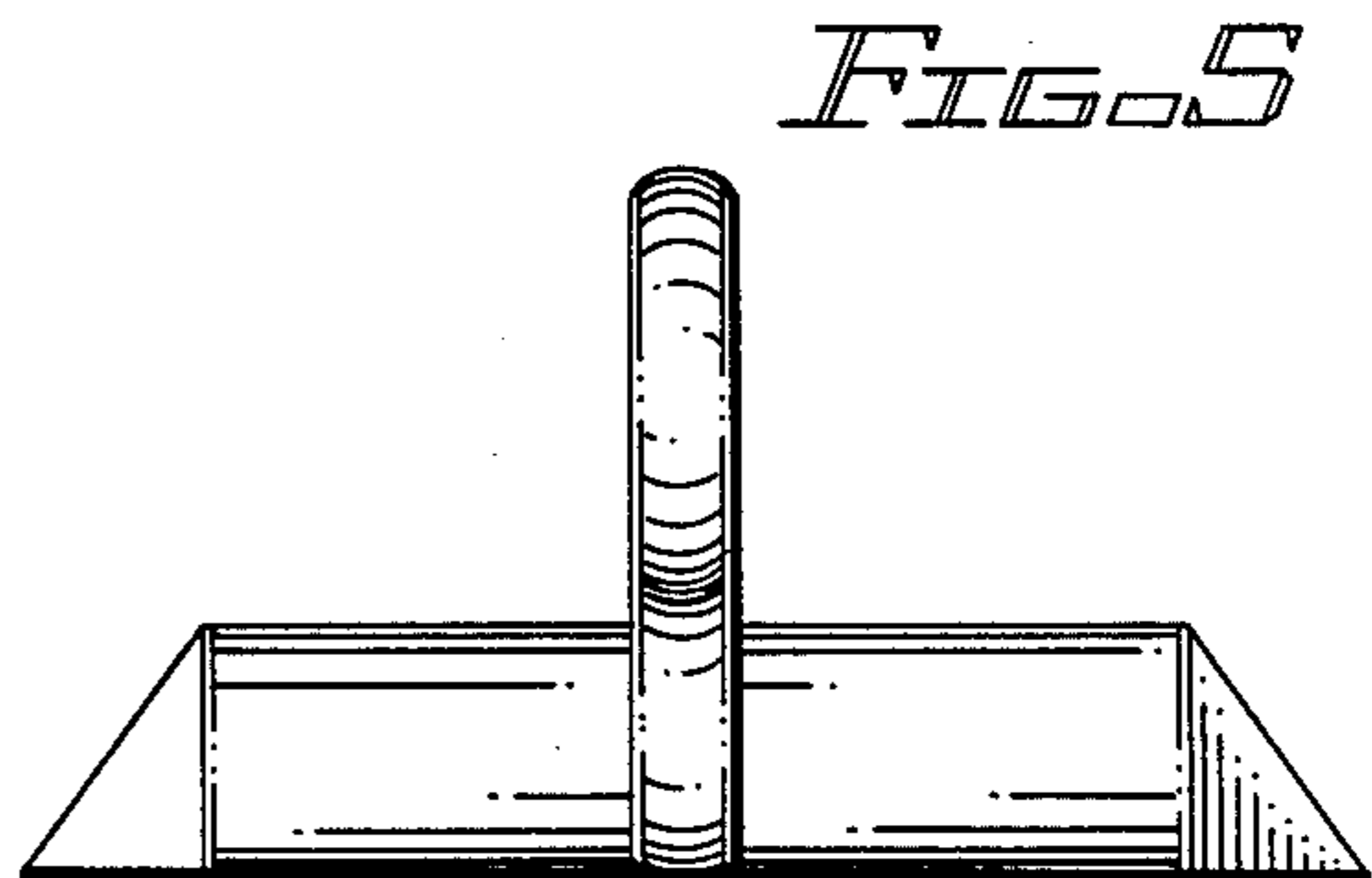

FIG. 5

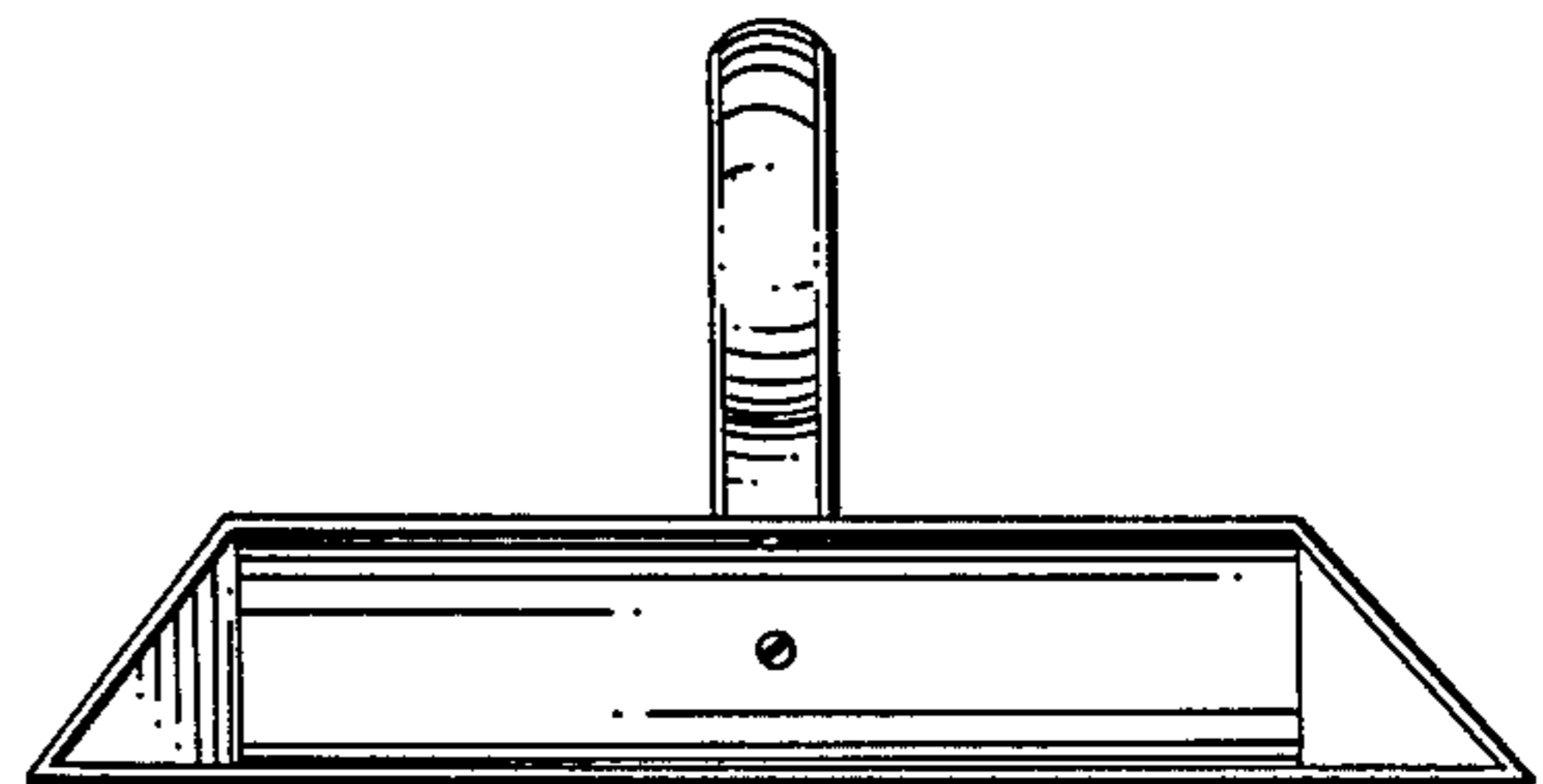

FIG. 6