

# United States Patent [19]

Brown

[11] Patent Number: **Des. 304,100**

[45] Date of Patent: **\*\* Oct. 17, 1989**

[54] **BELT ATTACHED UMPIRE HAND PROTECTOR**

[76] Inventor: **Ronald N. Brown, 4195 S. Oneida, Denver, Colo. 80237**

[\*\*] Term: **14 Years**

[21] Appl. No.: **920,850**

[22] Filed: **Oct. 17, 1986**

[52] U.S. Cl. .... **D29/20**

[58] Field of Search ..... **D29/10, 11, 20; D3/100; 2/161 A, 158, 161 R, 16, 159; D24/49, 64**

[56] **References Cited**

**U.S. PATENT DOCUMENTS**

D. 246,077 10/1977 Gwon ..... D29/20  
D. 249,596 9/1978 Rule ..... D29/10

D. 251,459 4/1979 Enicks ..... D29/10  
245,753 8/1881 Sprague ..... D29/20  
2,394,136 2/1946 Bakke ..... 2/161  
4,400,829 8/1983 Willis ..... 2/16

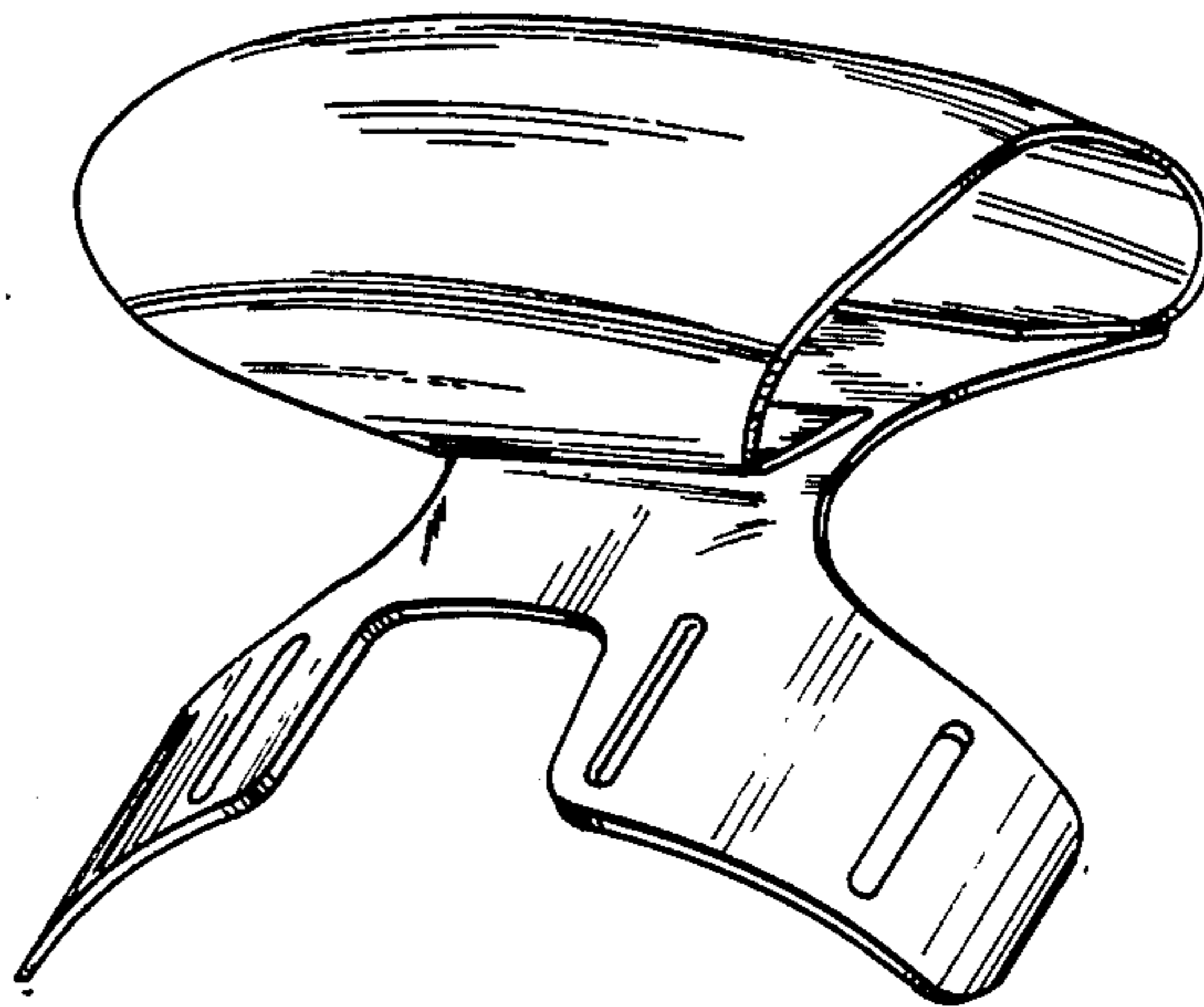
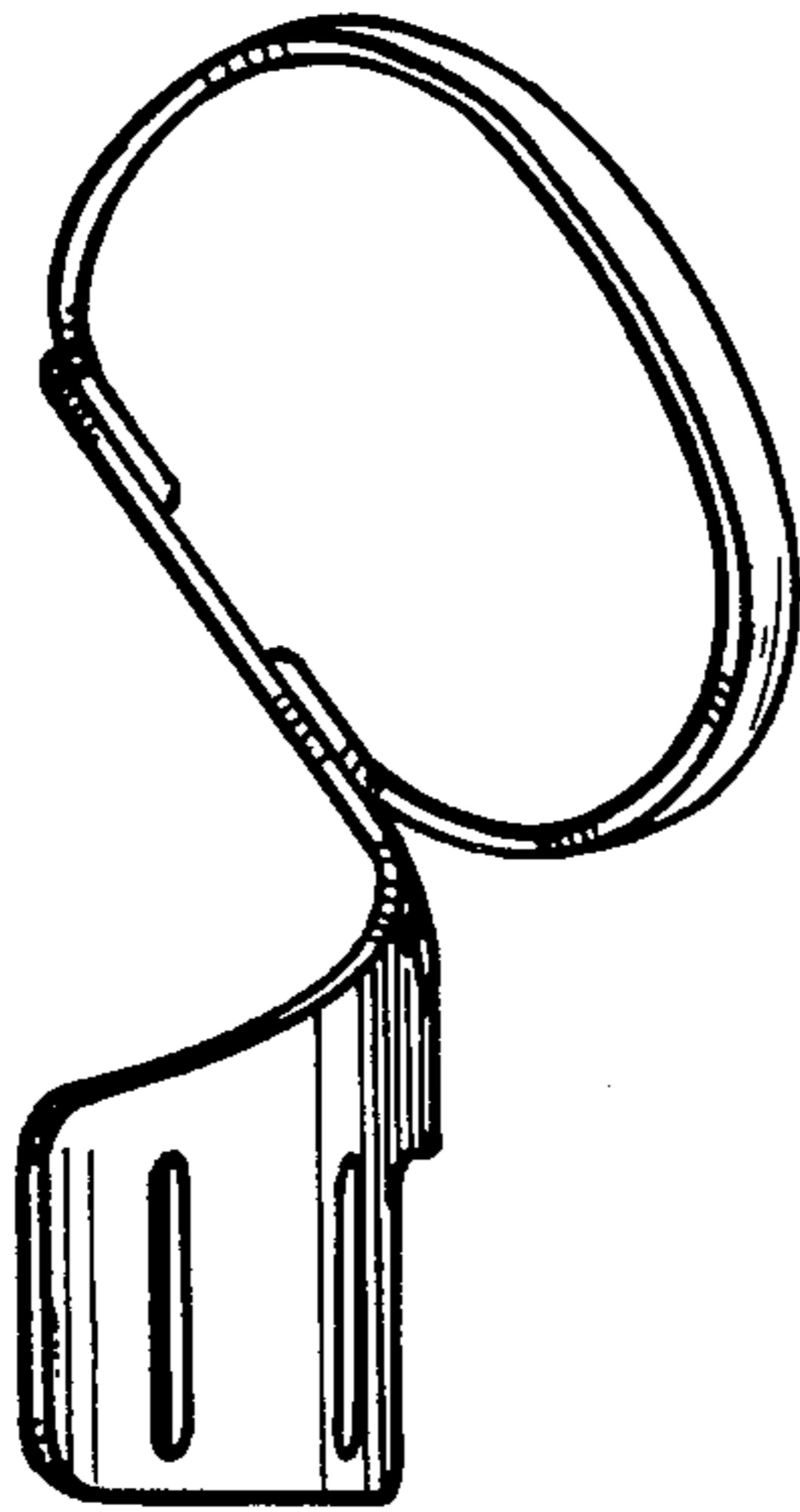
*Primary Examiner*—Carmen H. Vales-Lado

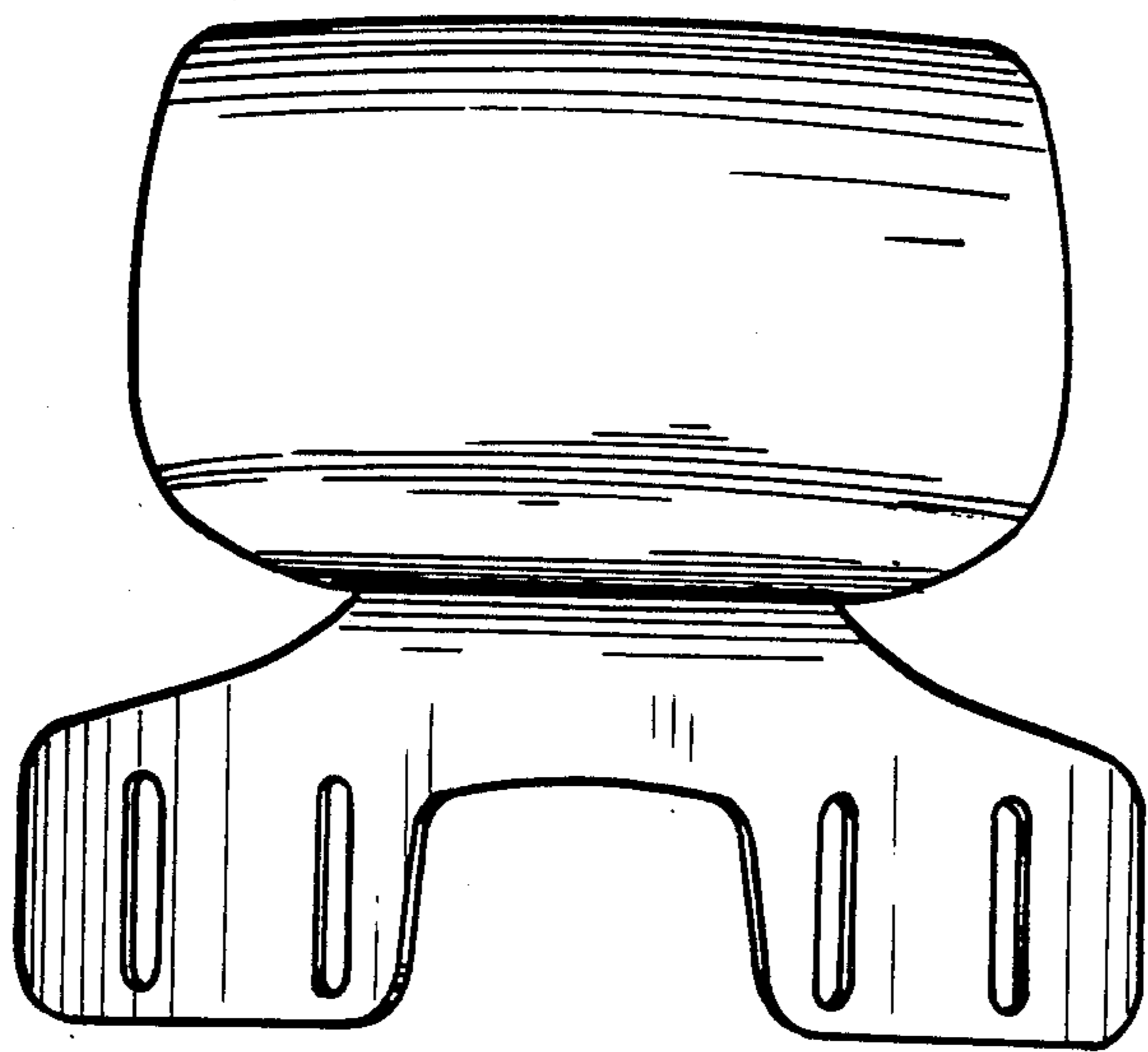
[57] **CLAIM**

The ornamental design for a belt attached umpire hand protector, as shown and described.

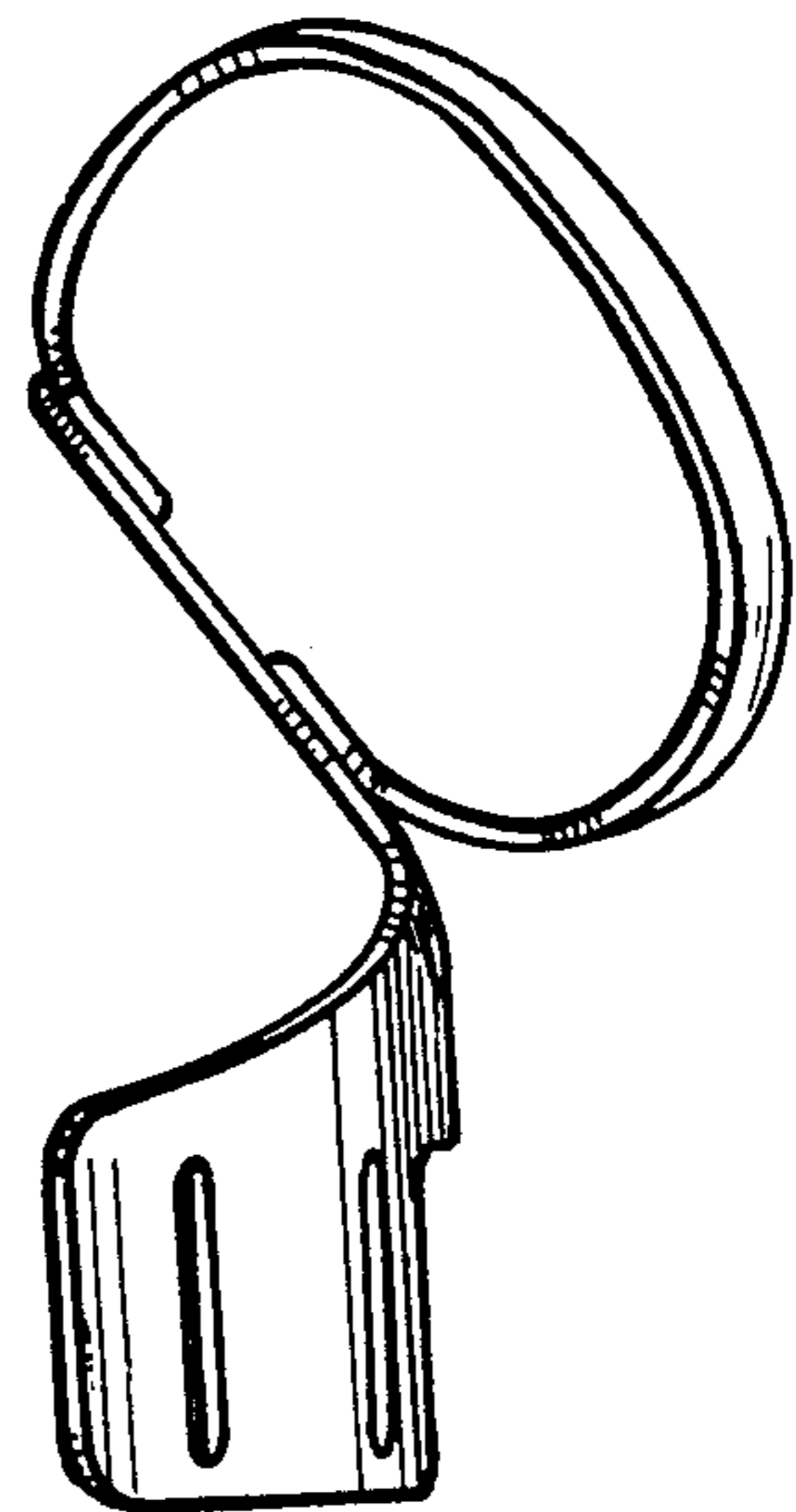
**DESCRIPTION**

FIG. 1 is a front elevational view view of a belt attached umpire hand protector showing my new design; FIG. 2 is a left side elevational view thereof; FIG. 3 is a right side elevational view thereof; FIG. 4 is a bottom plan view thereof; FIG. 5 is a rear elevational view thereof; FIG. 6 is a top plan view thereof; and FIG. 7 is a perspective view thereof.

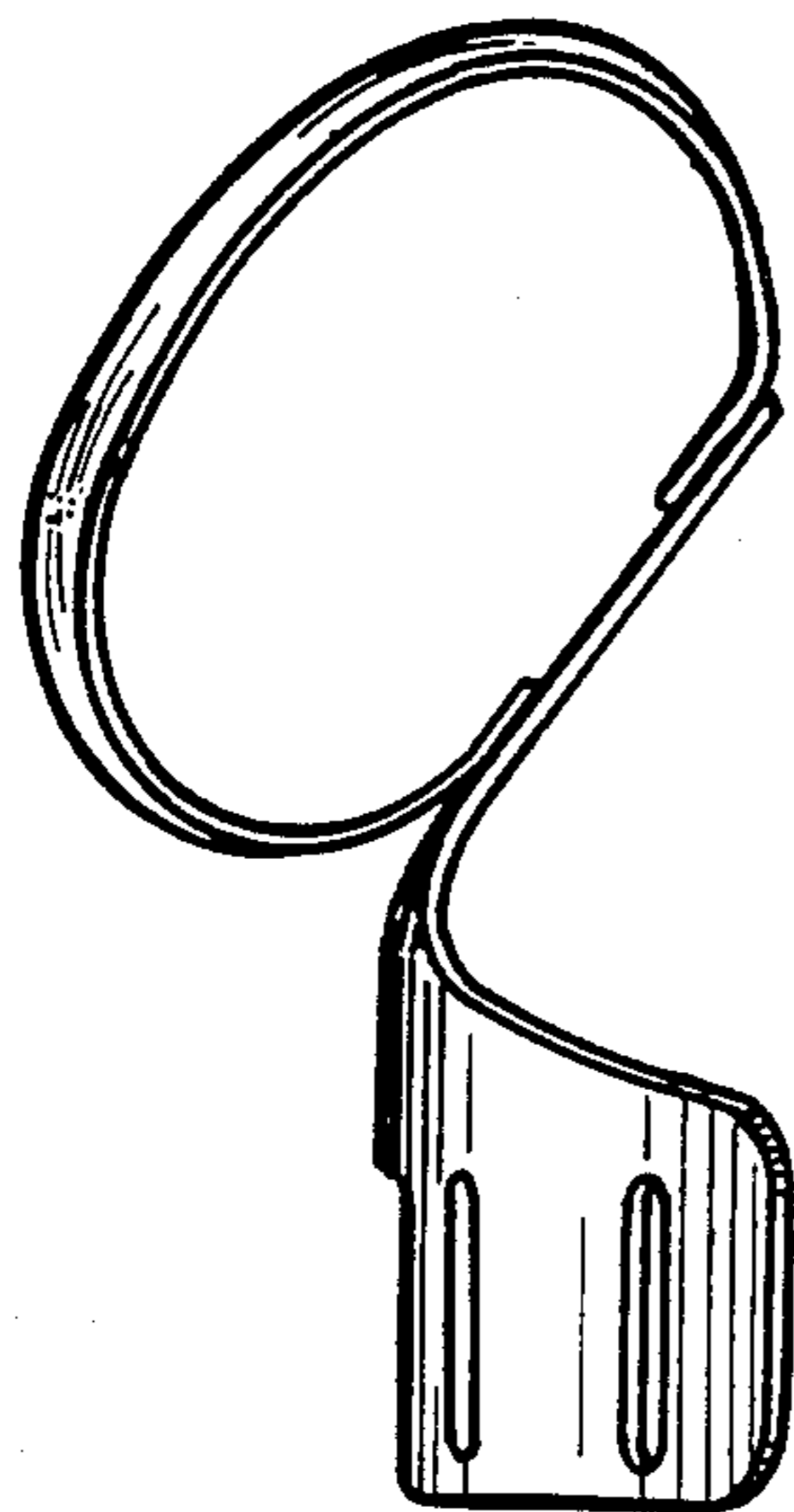




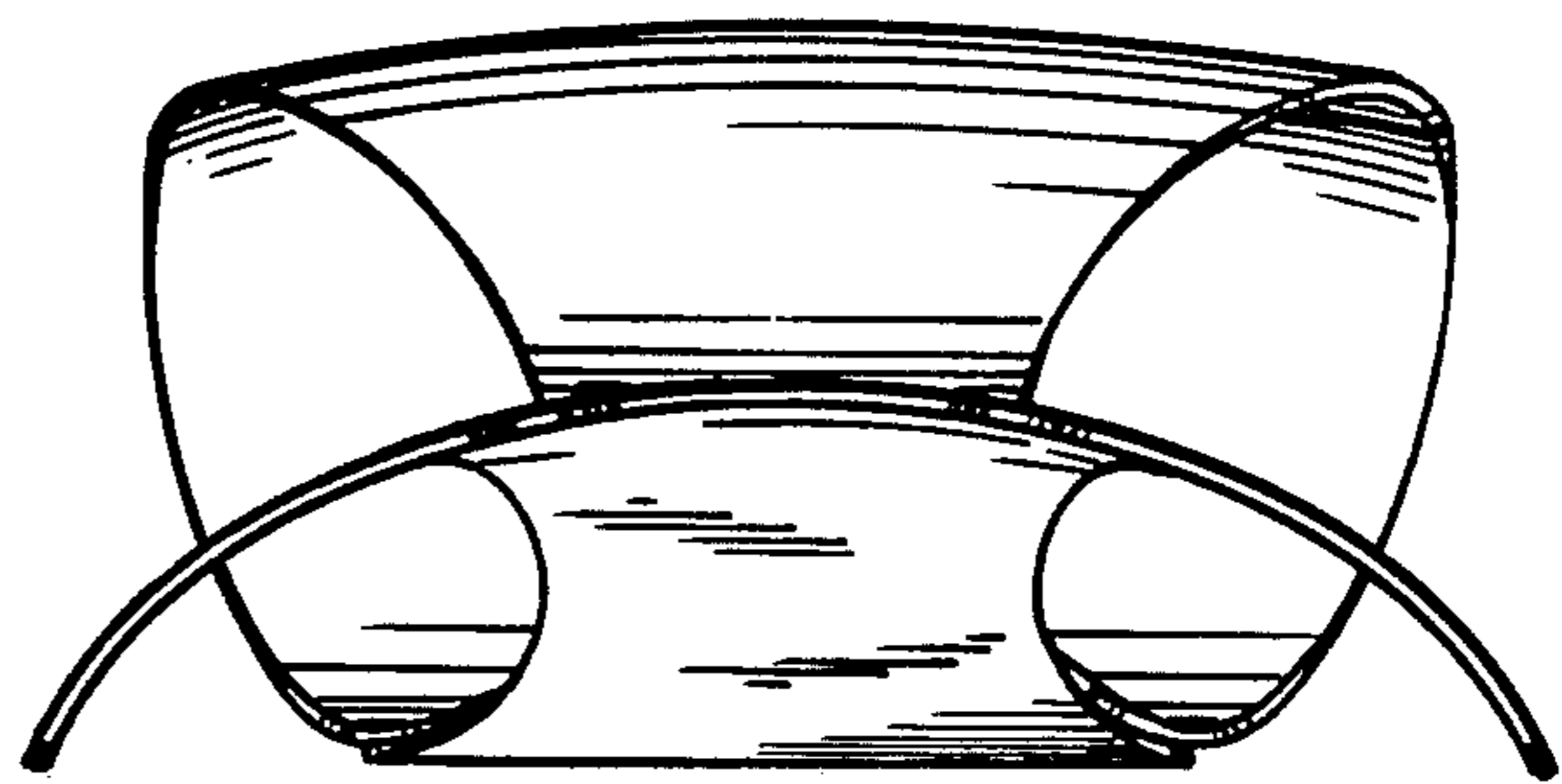
*Fig - 1*



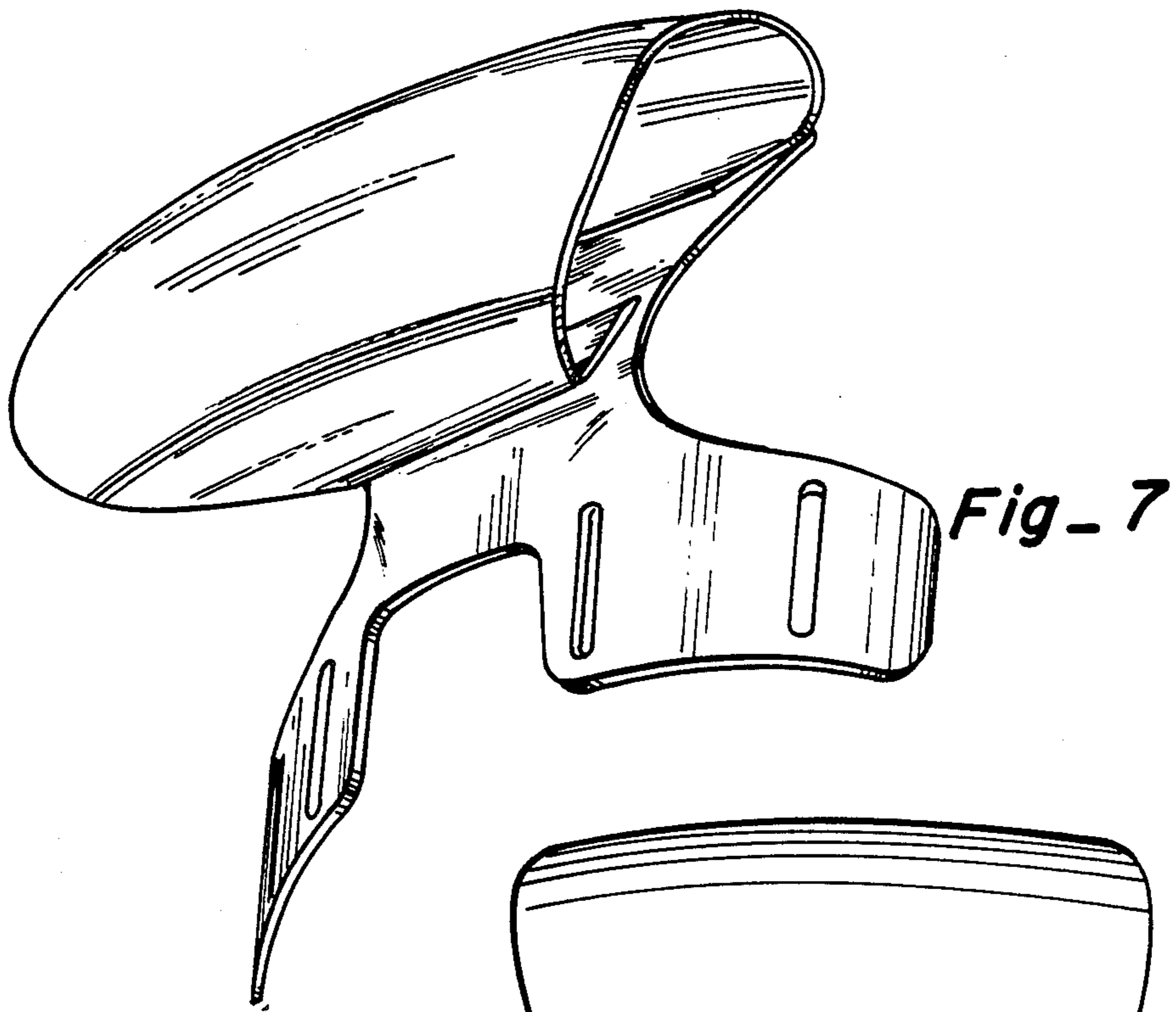
*Fig - 2*



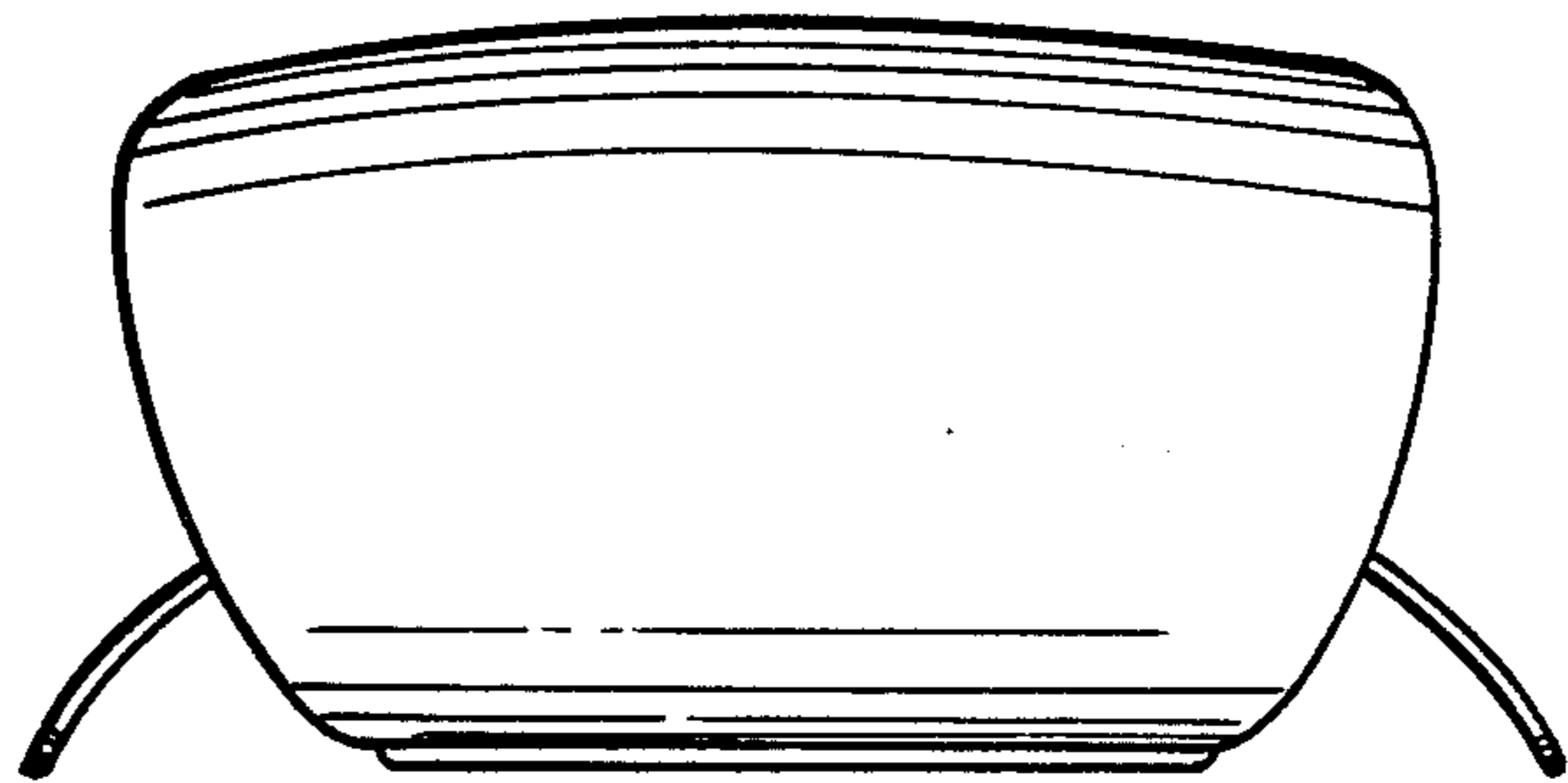
*Fig - 3*



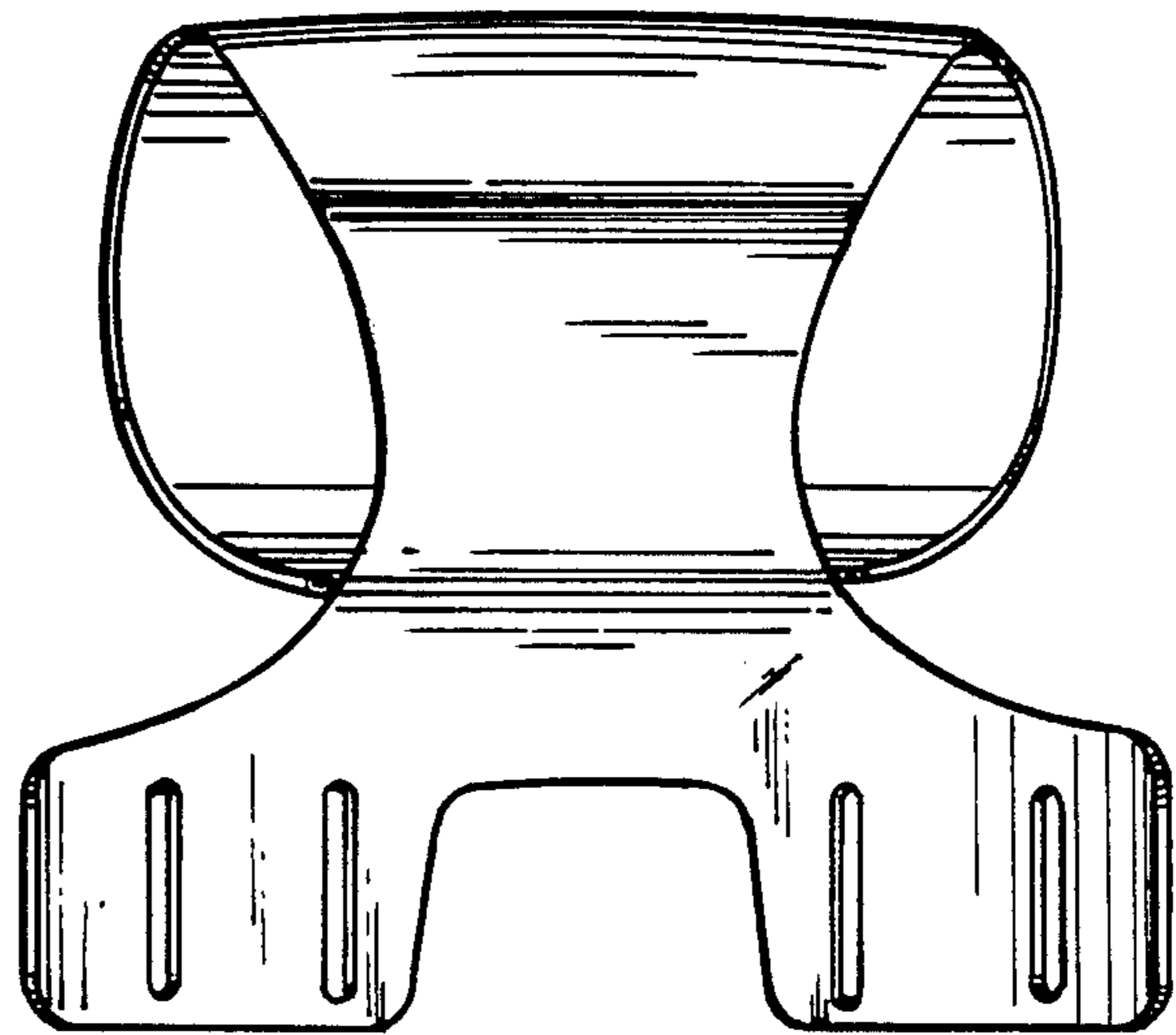
*Fig - 4*



*Fig. 7*



*Fig. 6*



*Fig. 5*