

[54] **COMPACT**
[75] **Inventor: Joel Desgrippes, Paris, France**
[73] **Assignee: Albion Cosmetics Co., Ltd., Japan**
[**] **Term: 14 Years**
[21] **Appl. No.: 40,200**
[22] **Filed: Apr. 17, 1987**
[30] **Foreign Application Priority Data**
Jan. 13, 1987 [JP] Japan 62-582
[52] **U.S. Cl. D28/78**
[58] **Field of Search D28/38, 61, 73-91;**
D3/39; D9/420, 423, 426; 132/286, 288, 293,
294, 297-301, 303-305, 313-318; 206/235, 385,
581, 823; 220/DIG. 26; 362/135-137
[56] **References Cited**
U.S. PATENT DOCUMENTS
D. 64,107 2/1924 Dowell D28/77

D. 77,889 3/1929 Buttrick et al. D9/423
1,472,350 10/1923 Albanese 132/301 X

Primary Examiner—Louis S. Zarfes
Attorney, Agent, or Firm—Kane, Dalsimer, Sullivan,
Kurucz, Levy, Eisele and Richard

[57] **CLAIM**

The ornamental design for a compact, as shown and described.

DESCRIPTION

FIG. 1 is a front perspective view of a compact showing my new design;
FIG. 2 is a perspective view similar to FIG. 1 except with the cover open;
FIG. 3 is a top plan view of FIG. 1;
FIG. 4 is a bottom plan view of FIG. 1;
FIG. 5 is a front elevational view of FIG. 1;
FIG. 6 is a back elevational view of FIG. 1;
FIG. 7 is a left side elevational view of FIG. 1;
FIG. 8 is a right side elevational view of FIG. 1.

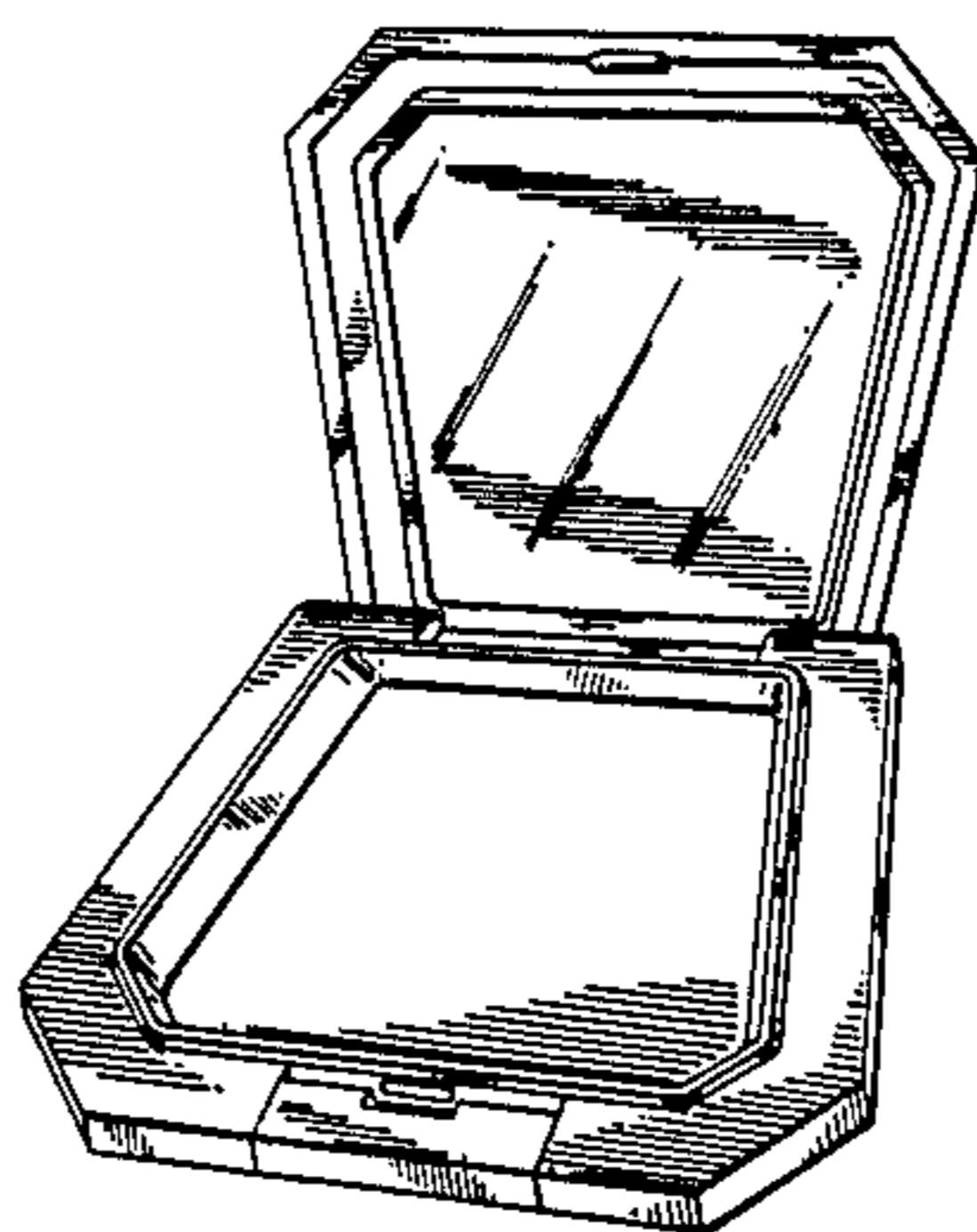
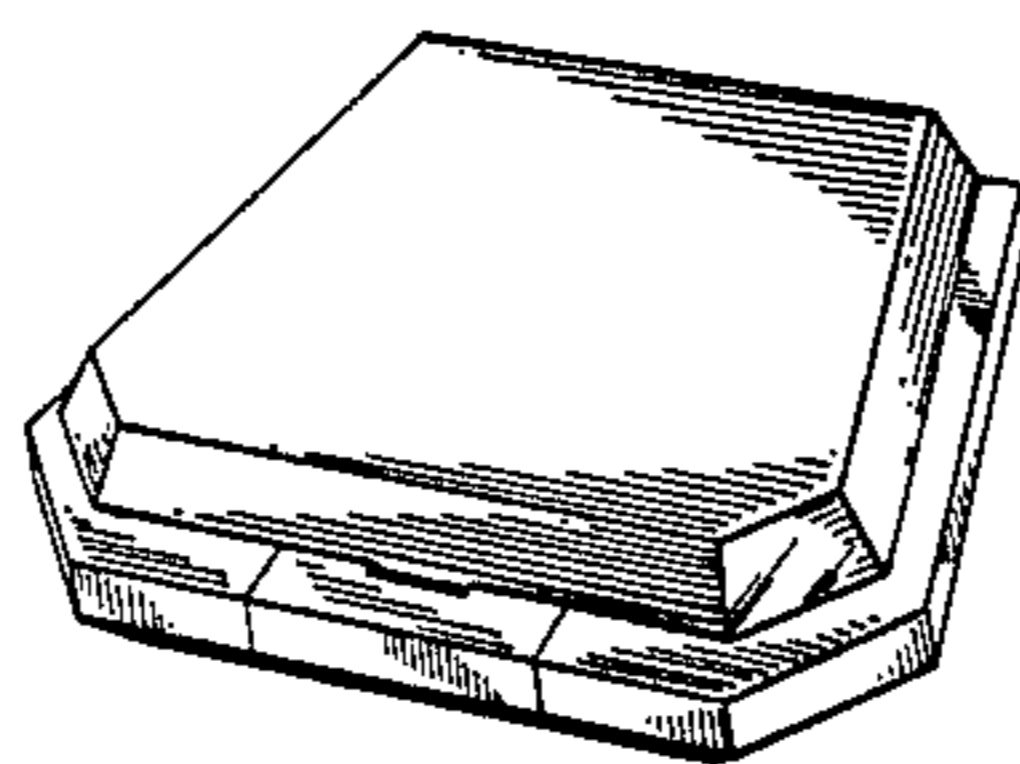

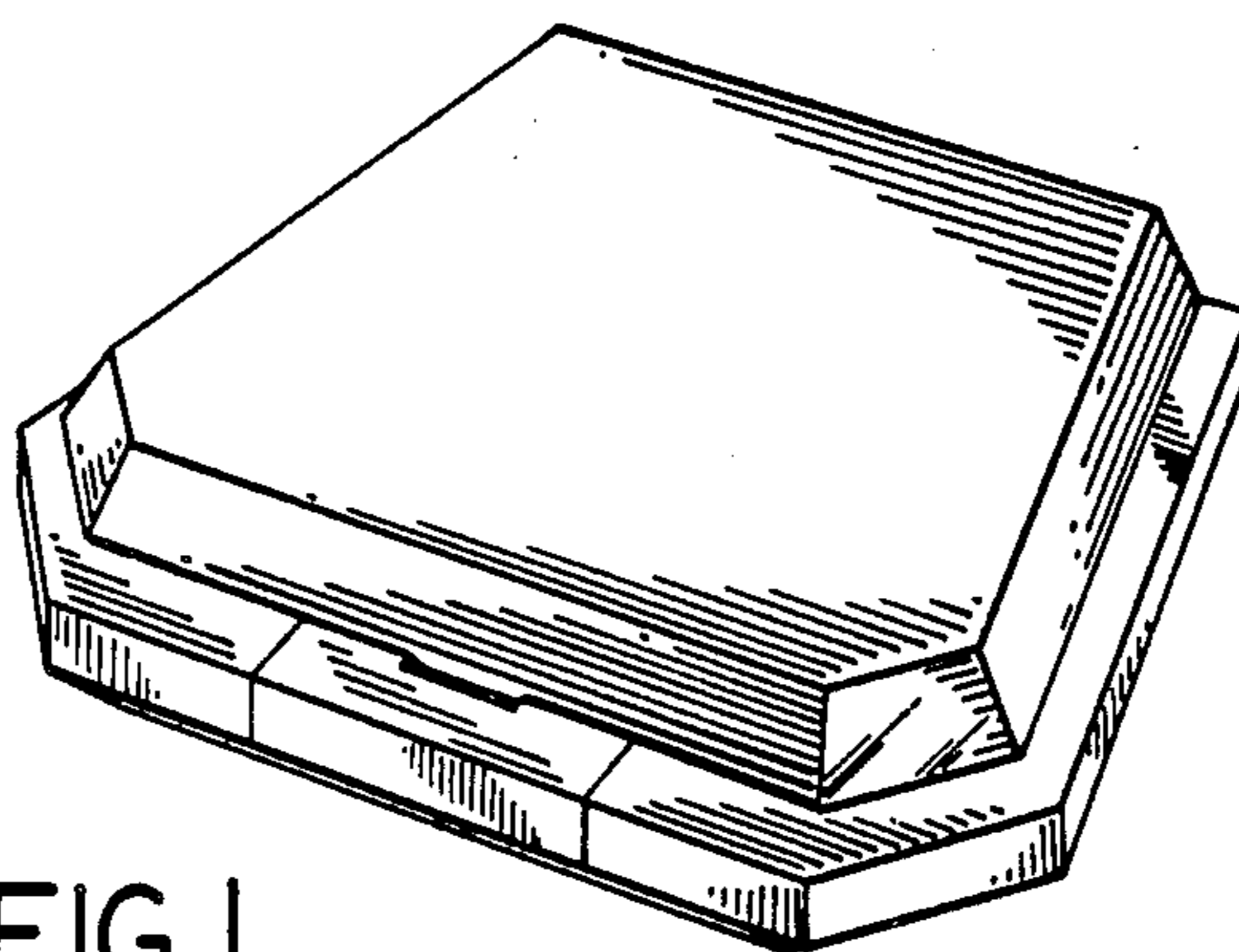

FIG. 1

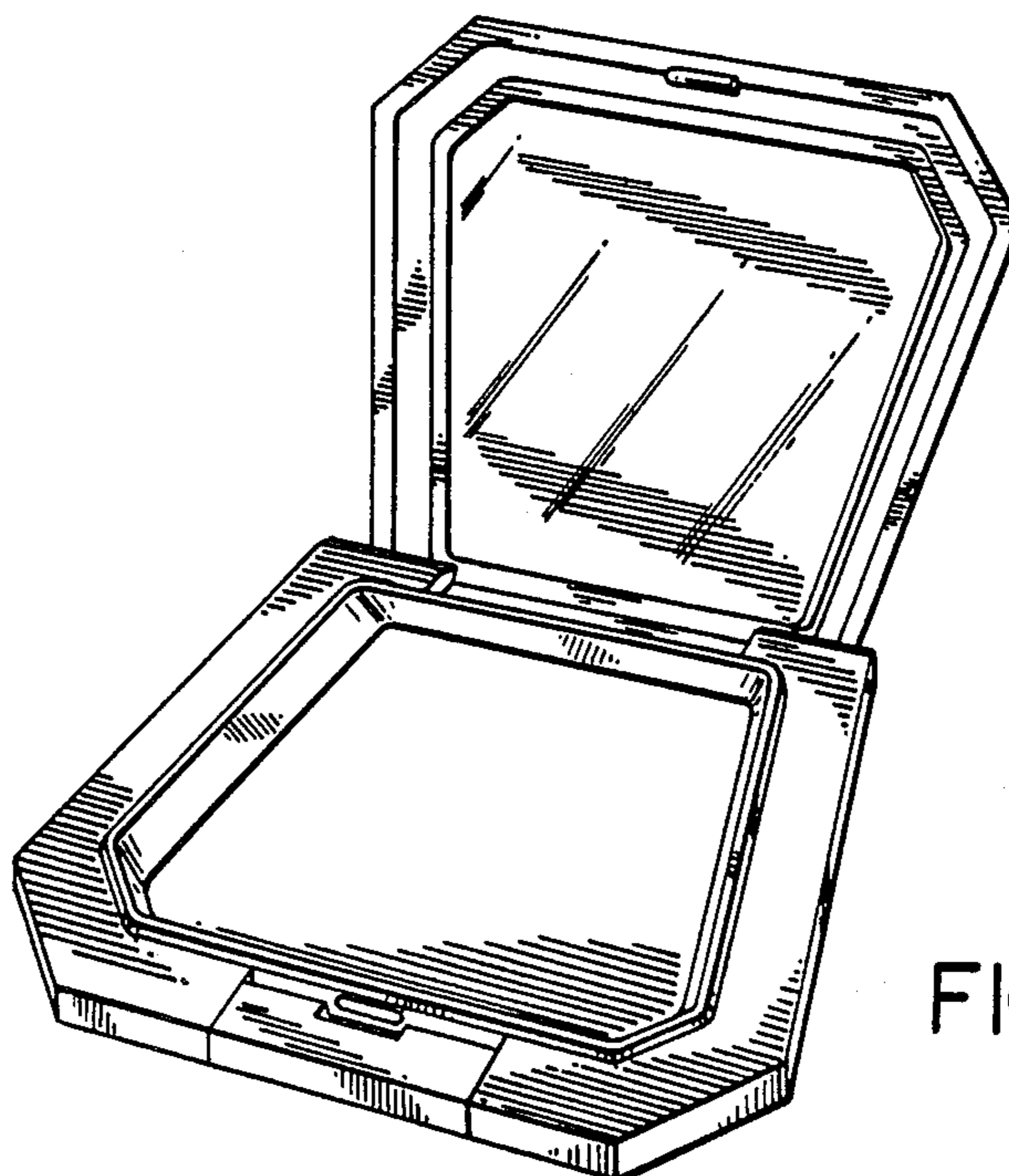

FIG. 2

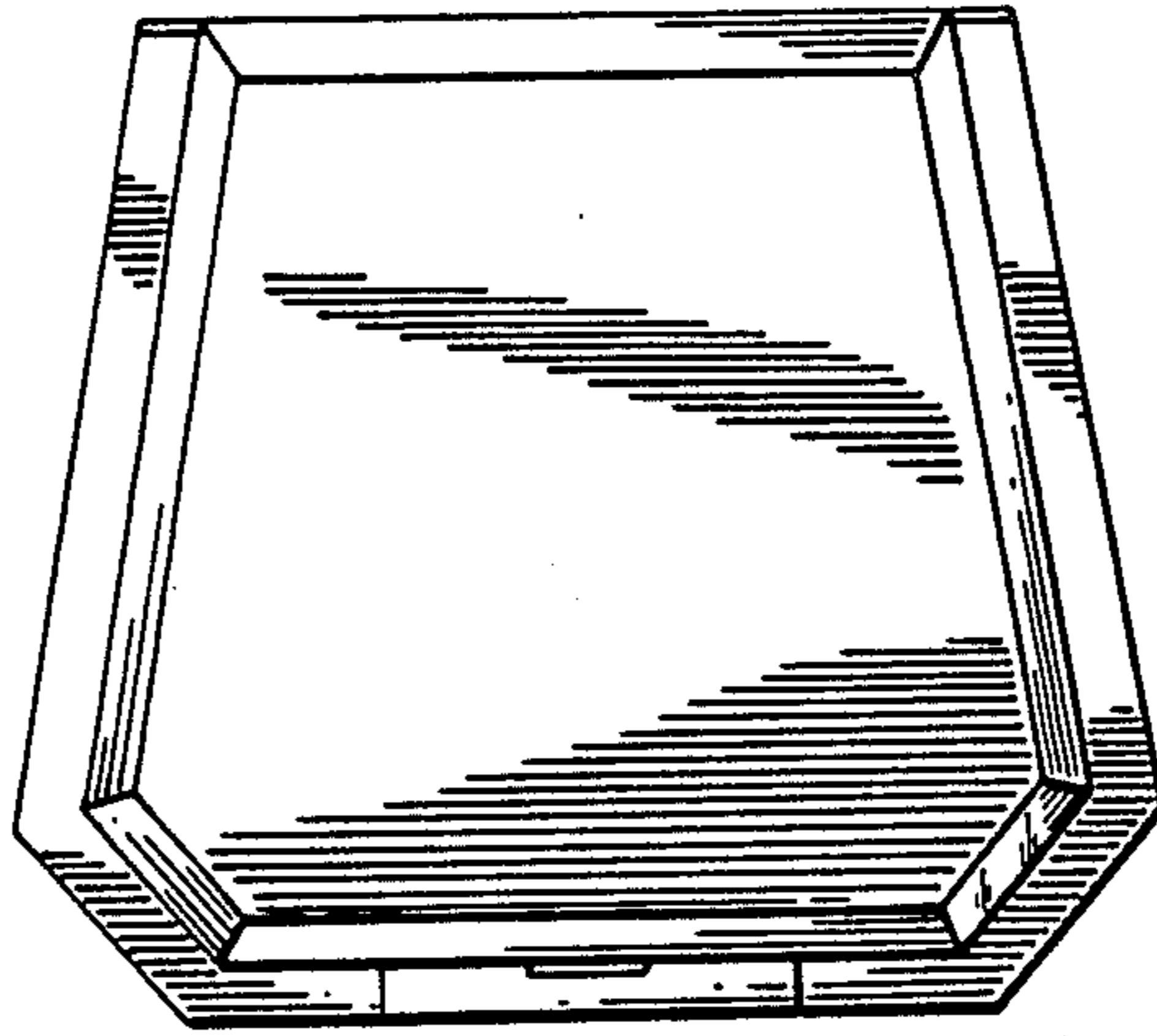

FIG. 3

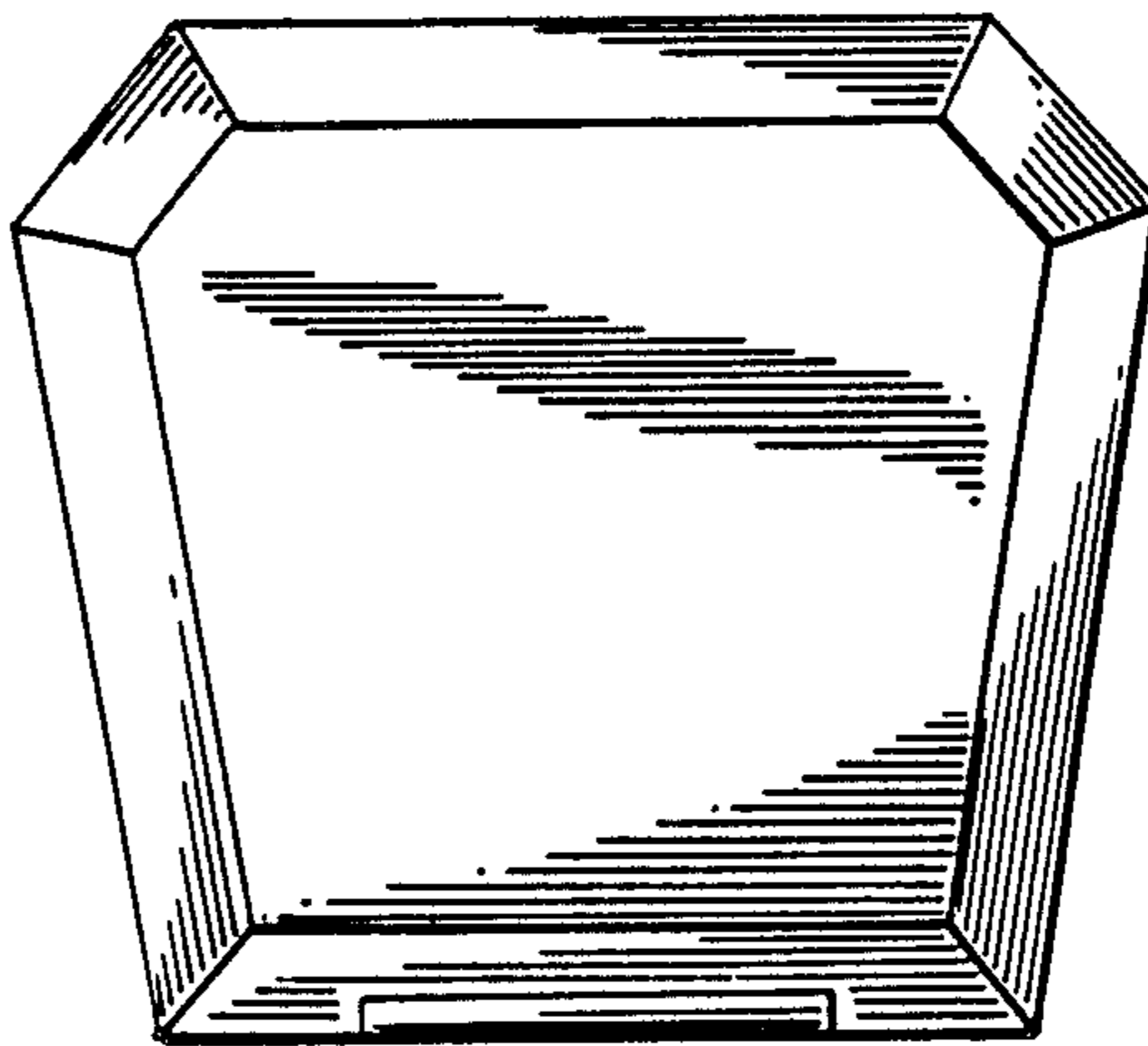

FIG. 4

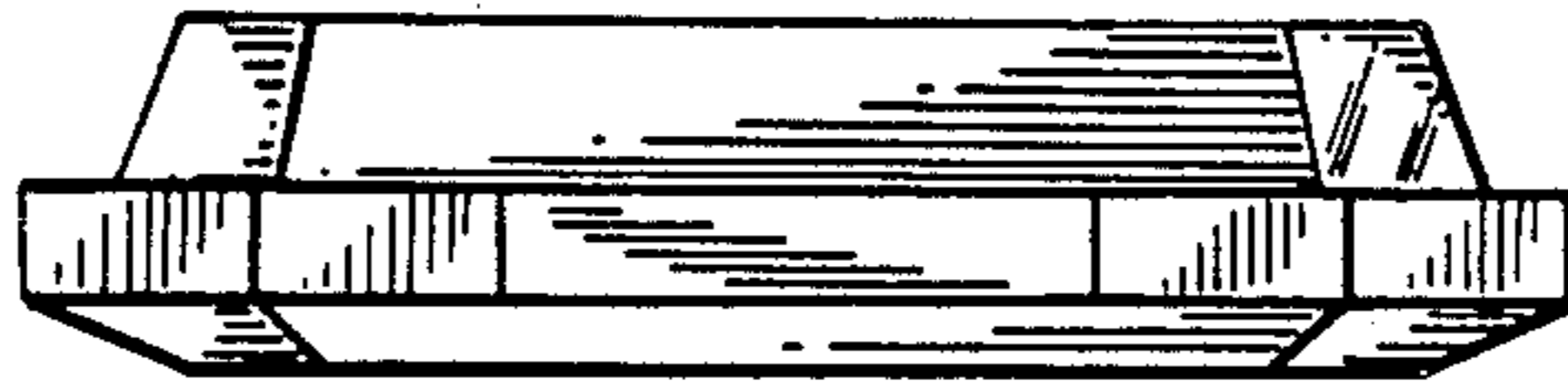

FIG. 5

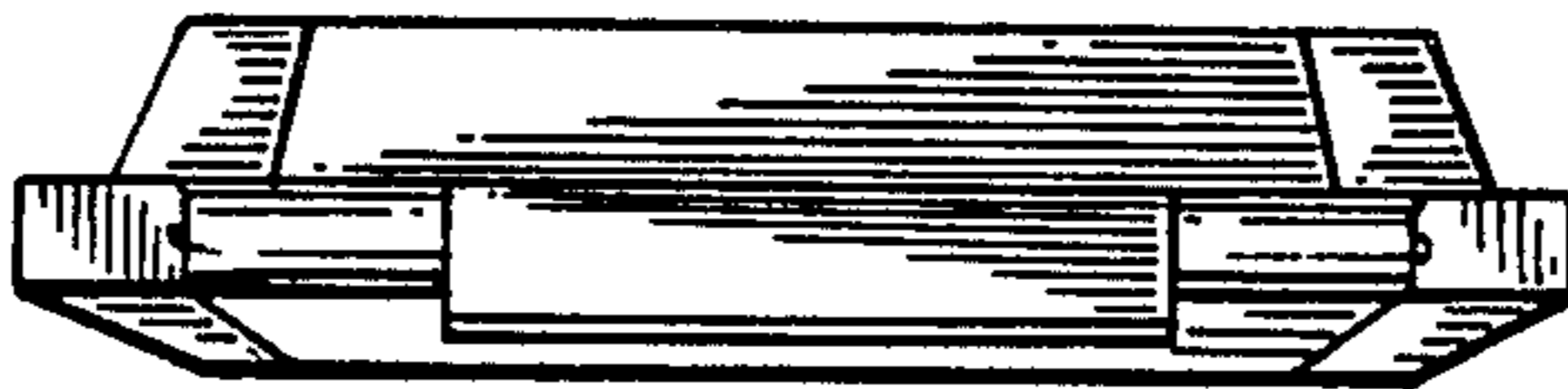

FIG. 6

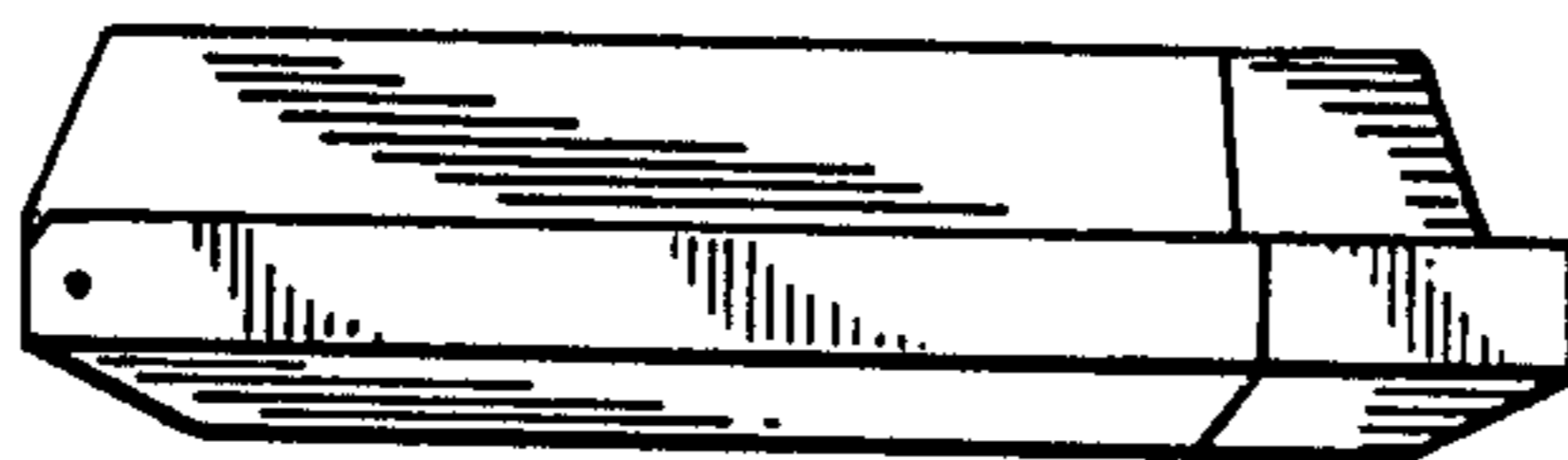

FIG. 7

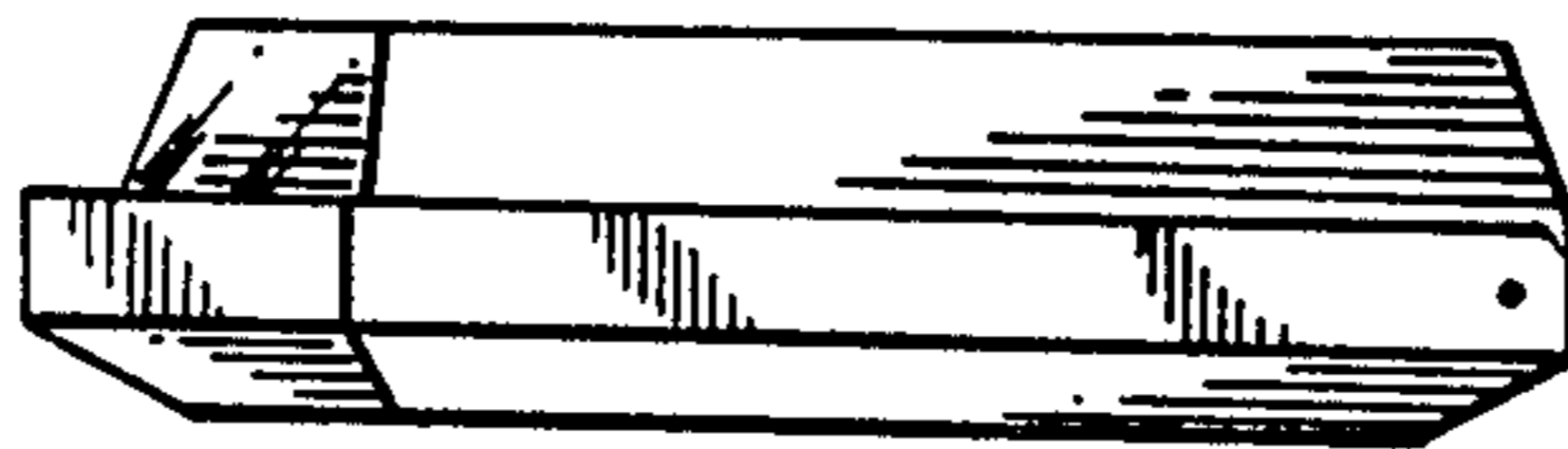

FIG. 8