

[54] TAPE PLAYER ADAPTER FOR CAR RADIOS

[75] Inventors: Dennis Michels, New York, N.Y.; Alan Kaplan, West Orange; Vincent Fusco, Clifton, both of N.J.

[73] Assignee: Sound Sender, Inc., East Hanover, N.J.

[\*\*] Term: 14 Years

[21] Appl. No.: 804,370

[22] Filed: Nov. 8, 1985

[52] U.S. Cl. .... D14/155; D13/28; D14/260; D14/265

[58] Field of Search ..... D14/1, 10, 11, 68, 76, D14/94, 95, 96, 99; D13/24, 28; 455/345, 346, 20, 128

[56] References Cited

U.S. PATENT DOCUMENTS

D. 209,284	11/1967	Busch	.....	D13/24
D. 243,537	3/1977	Wahl	.....	D14/95
D. 263,951	4/1982	Antretter et al.	.....	D13/24
4,286,262	8/1981	Wahl	.....	455/128 X

OTHER PUBLICATIONS

Radio Shack 1984 Catalog, ©1983, p. 64, top left—Universal DC Auto Adapter.

Hong Kong Enterprise, 4/84, p. 32, left side—Item Nos. MW 228, MW 188, and MW 191.

Primary Examiner—Bernard Ansher  
Assistant Examiner—Theodore M. Shooman  
Attorney, Agent, or Firm—Weingram & Zall

[57] CLAIM

The ornamental design for tape player adapter for car radios, as shown.

DESCRIPTION

FIG. 1 is a top, front and right side perspective view of a tape player adapter for car radios showing our new design;

FIG. 2 is a right side elevational view thereof;

FIG. 3 is a left side elevational view thereof;

FIG. 4 is a top plan view thereof;

FIG. 5 is a front elevational view thereof;

FIG. 6 is a bottom plan view thereof; and

FIG. 7 is a rear elevational view thereof.

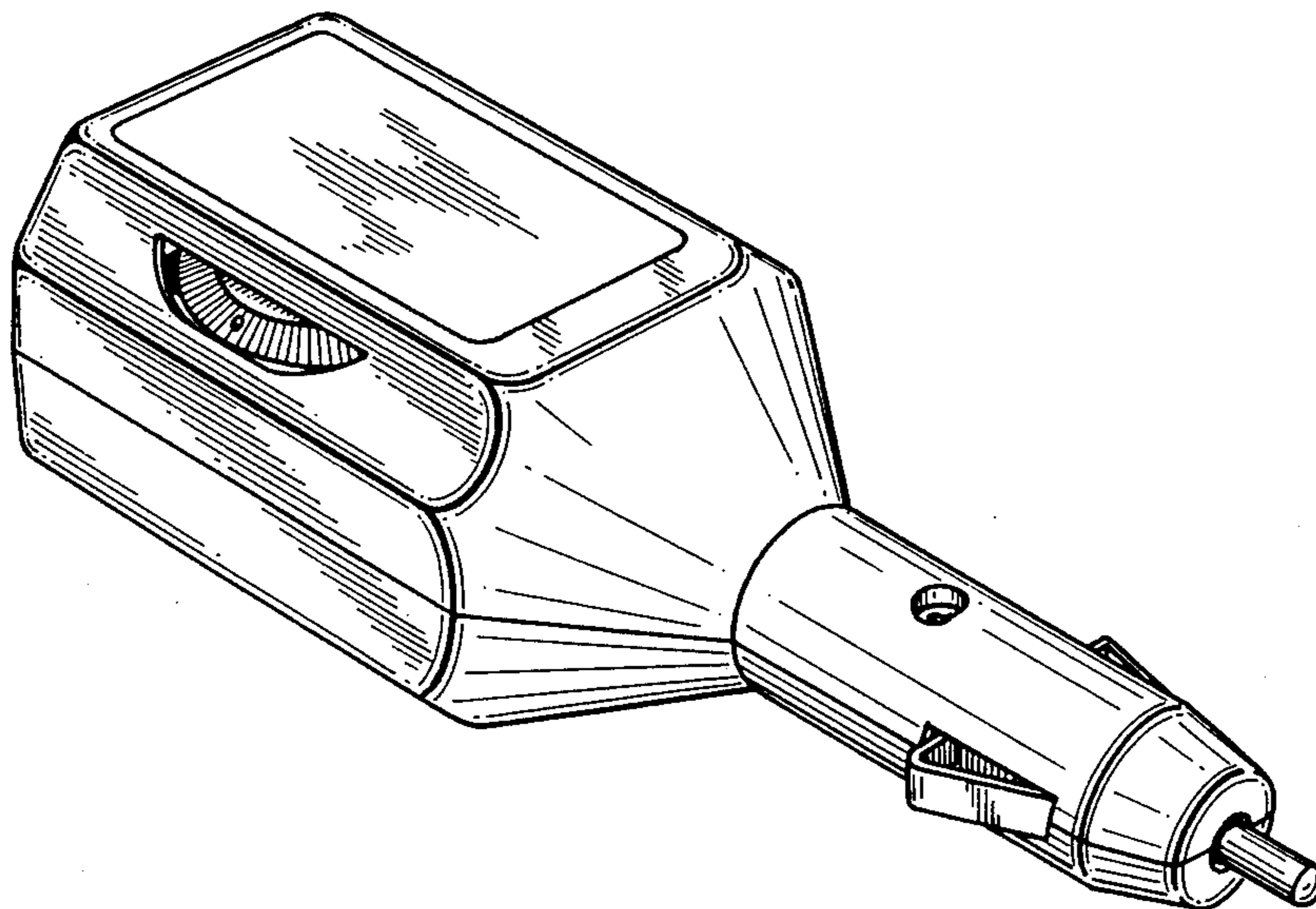

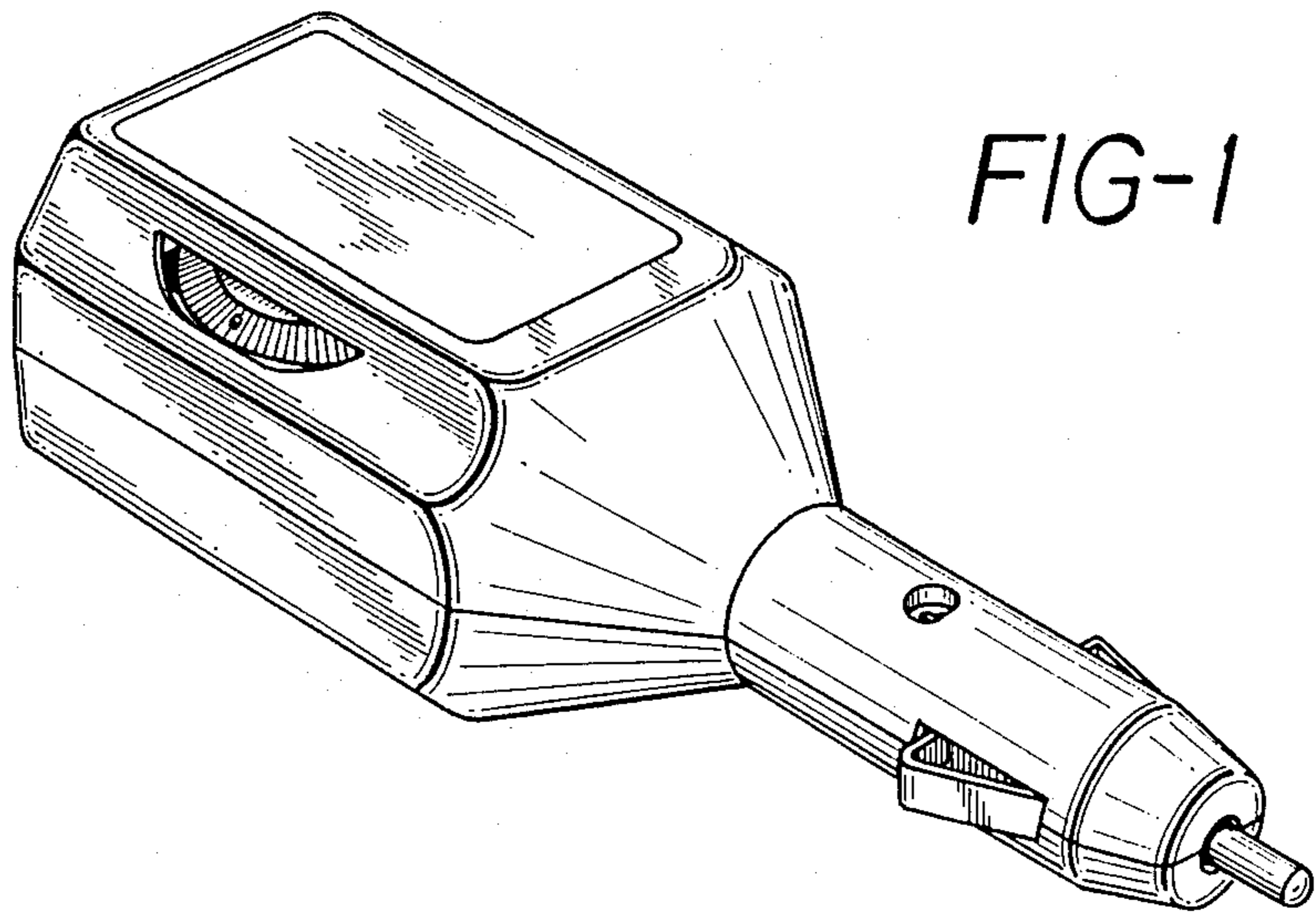

FIG-2

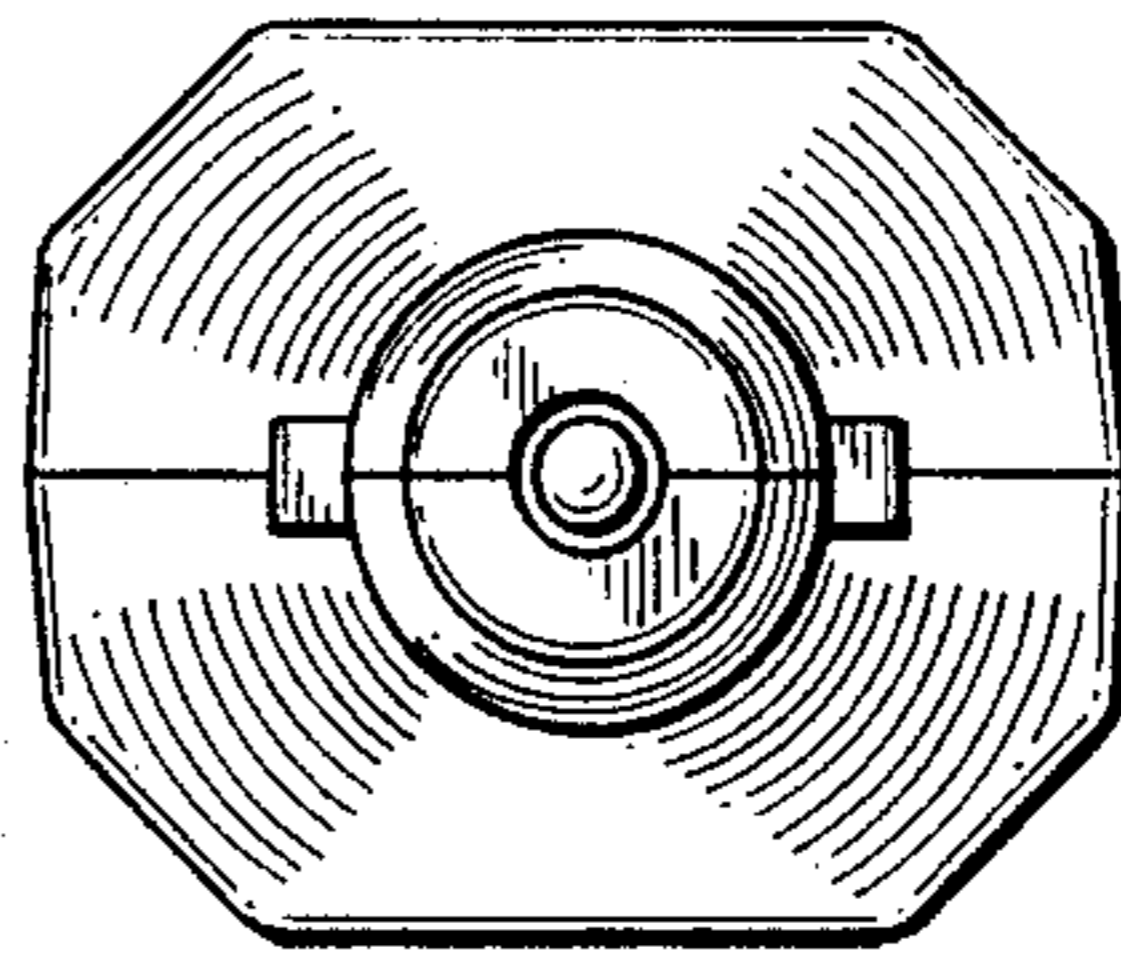

FIG-3

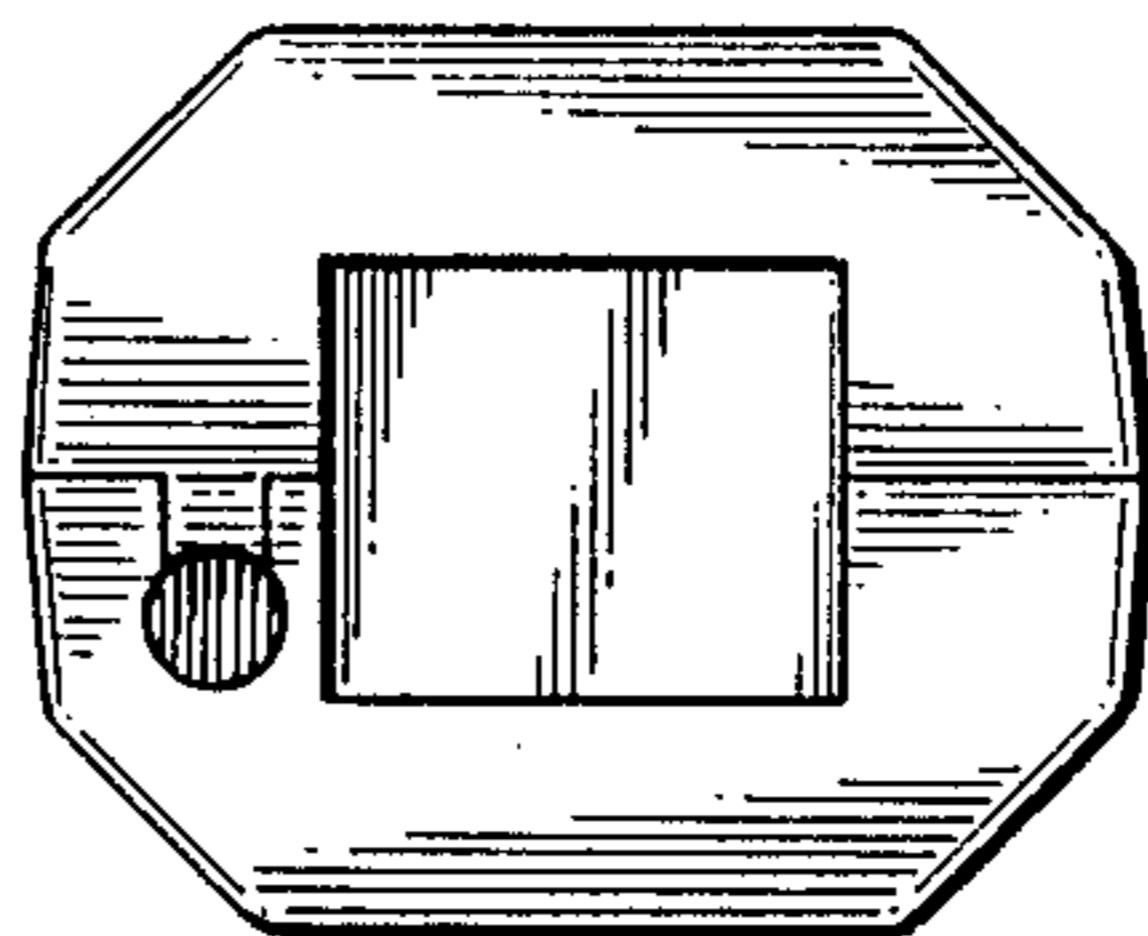

FIG-4

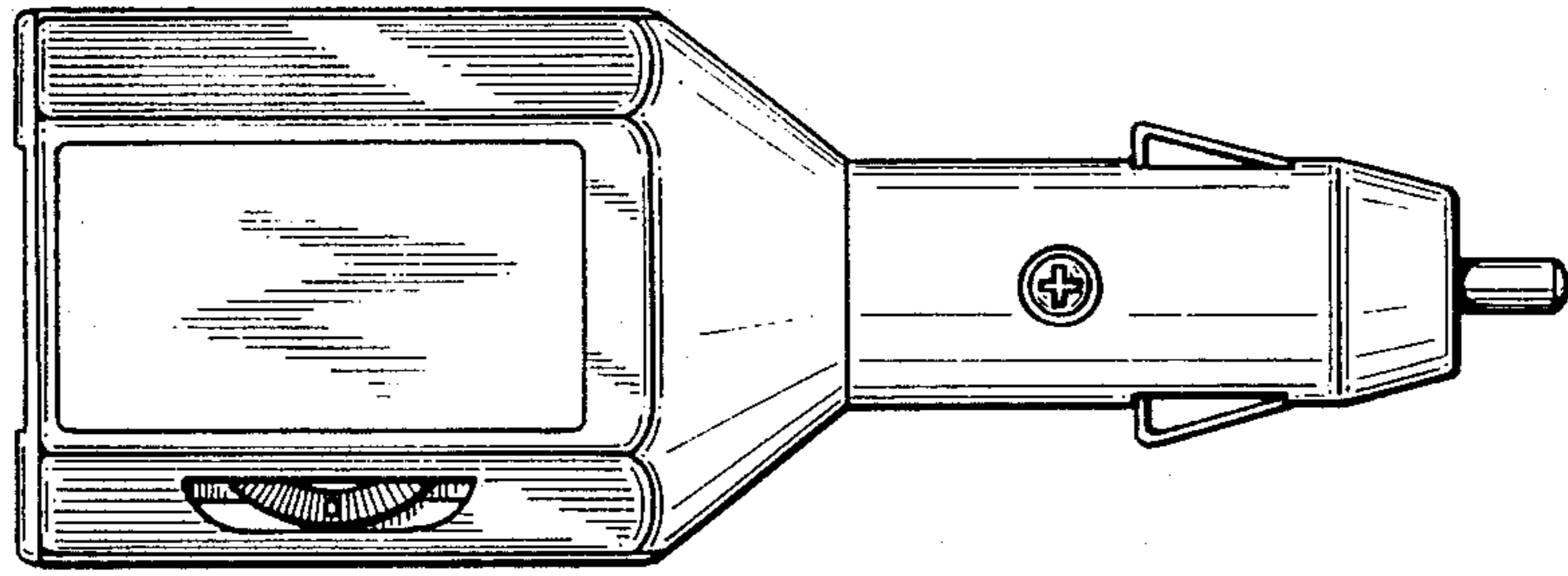

FIG-5

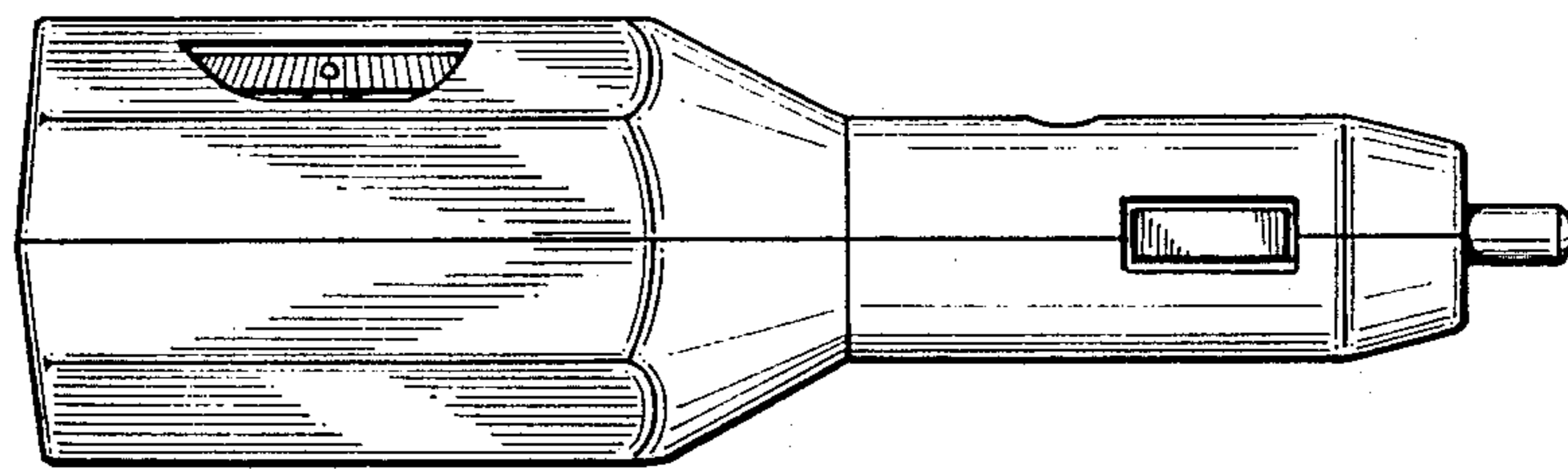

FIG-6

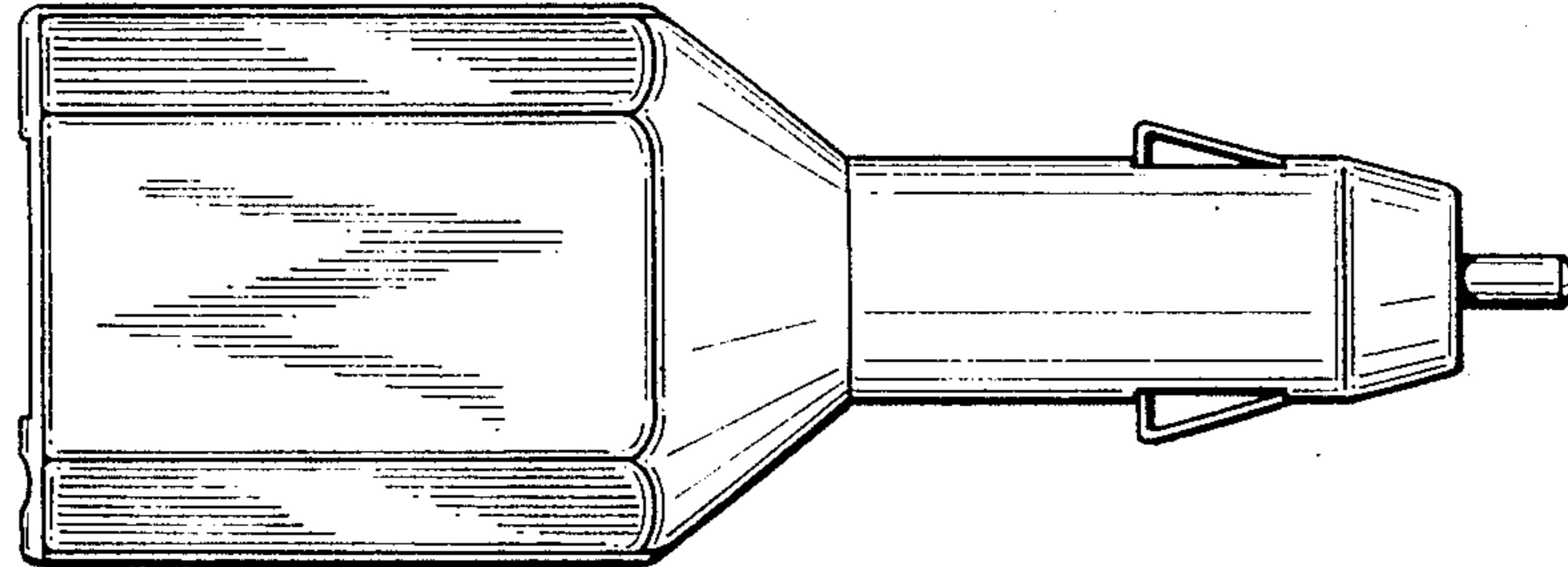

FIG-7

