

United States Patent [19]

Bottcher

[11] **Patent Number: Des. 303,942**

[45] **Date of Patent: ** Oct. 10, 1989**

[54] **CORNER SUPPORT BRACKET FOR PLAQUES OR THE LIKE**

[76] **Inventor: Charles E. Bottcher, Redbud Rd., Oneonta, Ala. 35121**

[**] **Term: 14 Years**

[21] **Appl. No.: 867,755**

[22] **Filed: May 29, 1986**

[52] **U.S. Cl. D11/164; D6/300**

[58] **Field of Search D11/164; D6/300; 40/156; 248/466, 475.1**

[56] **References Cited**

U.S. PATENT DOCUMENTS

D. 151,375	10/1948	Koltnow	D6/300
D. 178,133	6/1956	Lurie	D6/300
D. 178,439	7/1956	Waller	D6/300
D. 282,414	2/1986	Rathle	D6/300
2,204,862	6/1940	Lehman	248/466
4,179,089	12/1979	Parr, Jr.	248/488
4,497,125	2/1985	Hutchinson	248/488

Primary Examiner—B. J. Bullock

Assistant Examiner—Dominic Simone

Attorney, Agent, or Firm—Jennings, Carter, Thompson & Veal

[57] **CLAIM**

The ornamental design for a corner support bracket for plaques or the like, as shown and described.

DESCRIPTION

FIG. 1 is a front perspective view of a corner support bracket for plaques or the like showing my new design; FIG. 2 is a rear perspective view thereof; FIG. 3 is a front elevational view thereof; FIG. 4 is a rear elevational view thereof; FIG. 5 is a left side elevational view thereof; FIG. 6 is a right side elevational view thereof; FIG. 7 is a top plan view thereof; FIG. 8 is a bottom plan view thereof; FIG. 9 is a perspective view thereof, the fragmented frame shown in broken lines for illustrative purposes only.

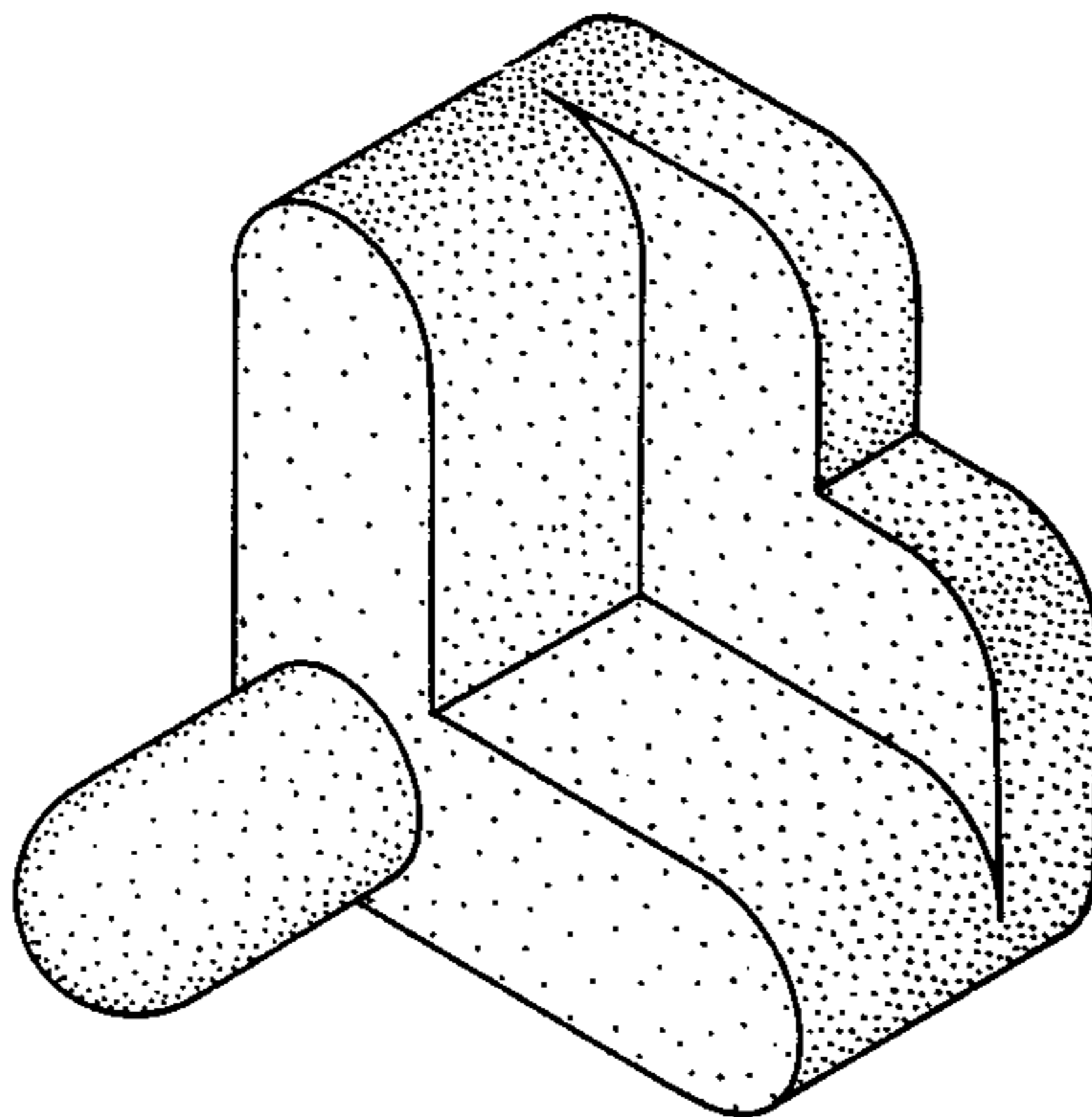

Fig. 1

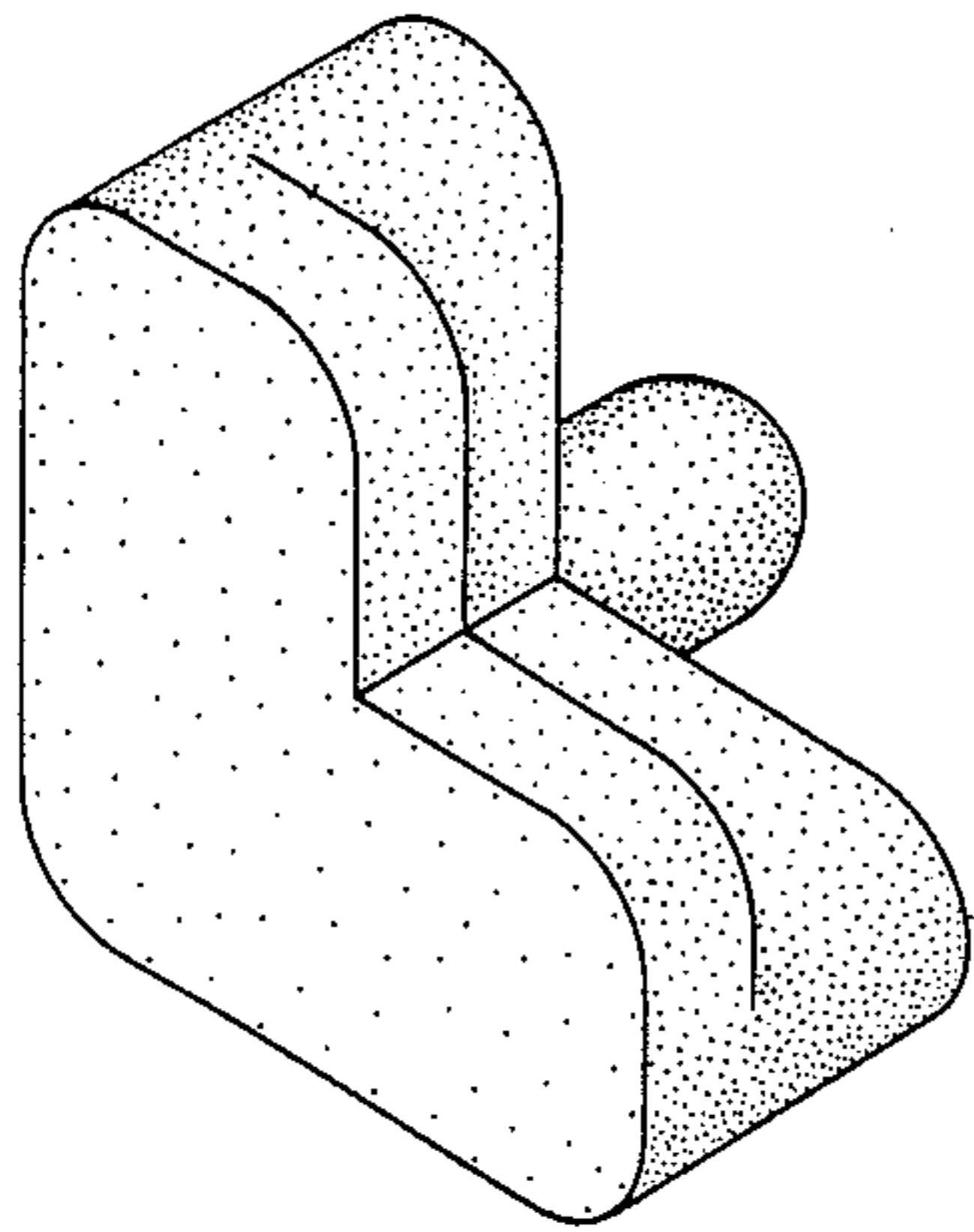

Fig. 2

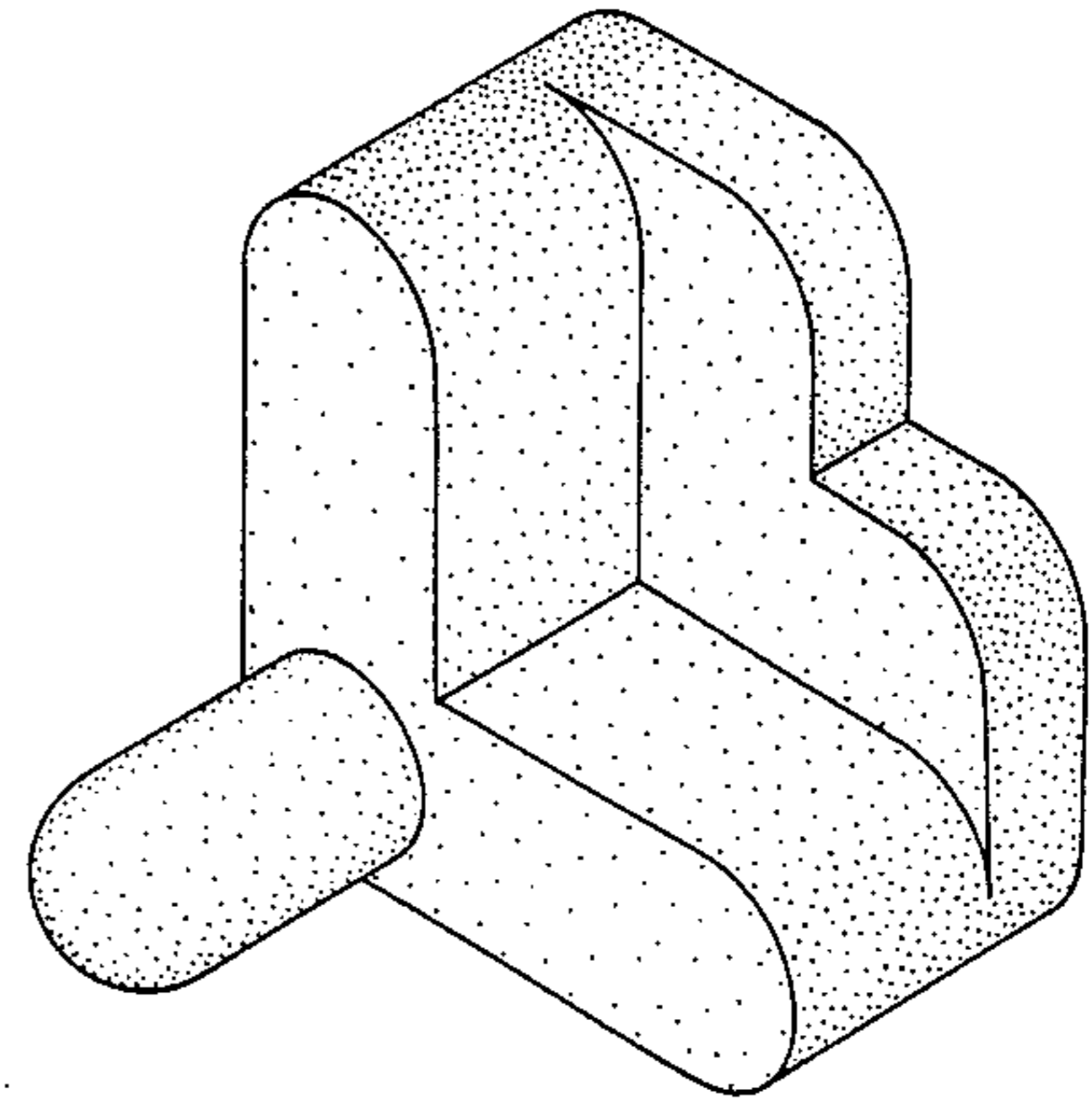

Fig. 3

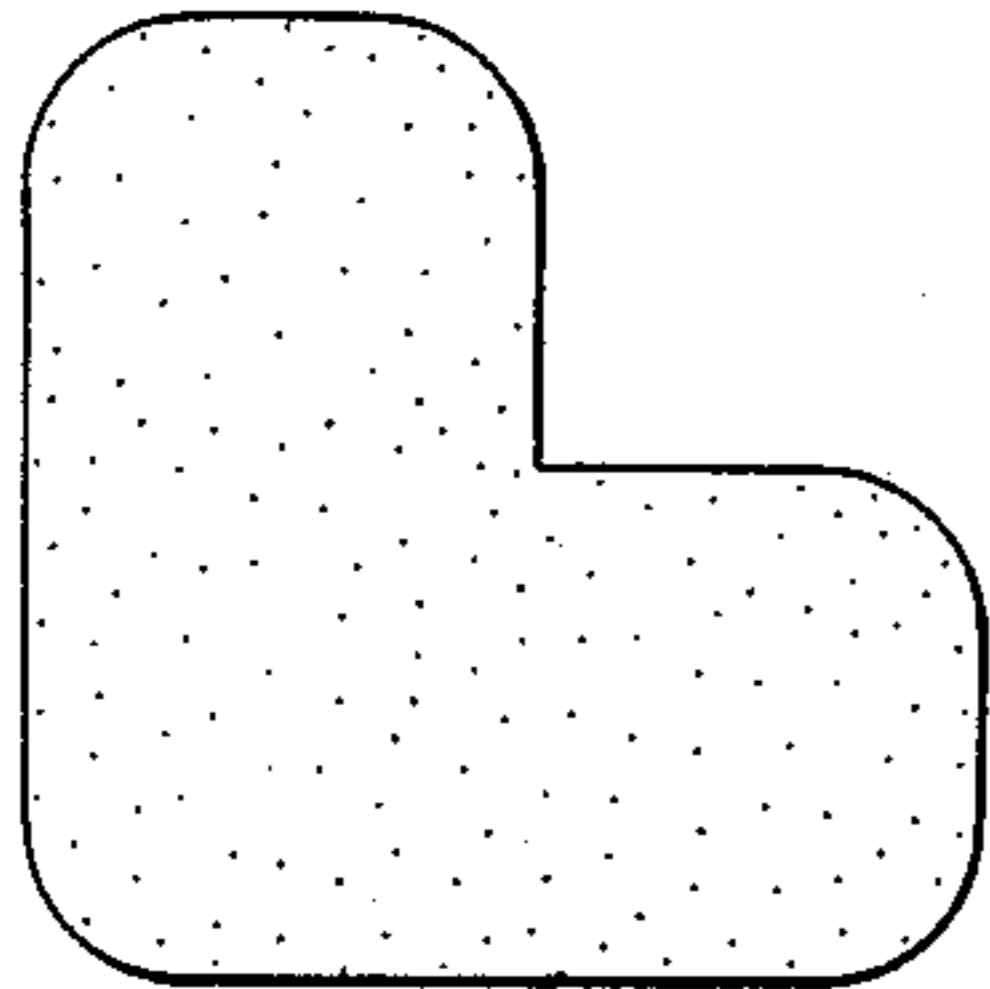

Fig. 4

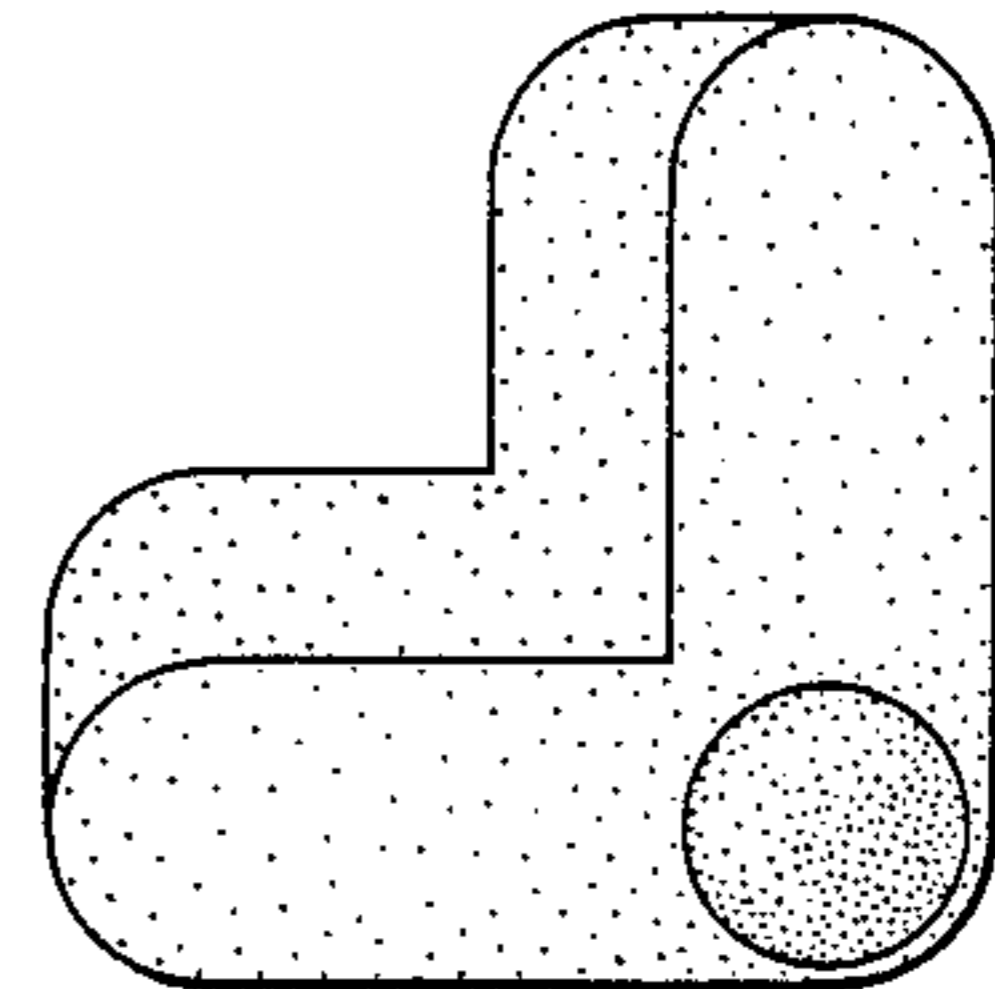

Fig. 5

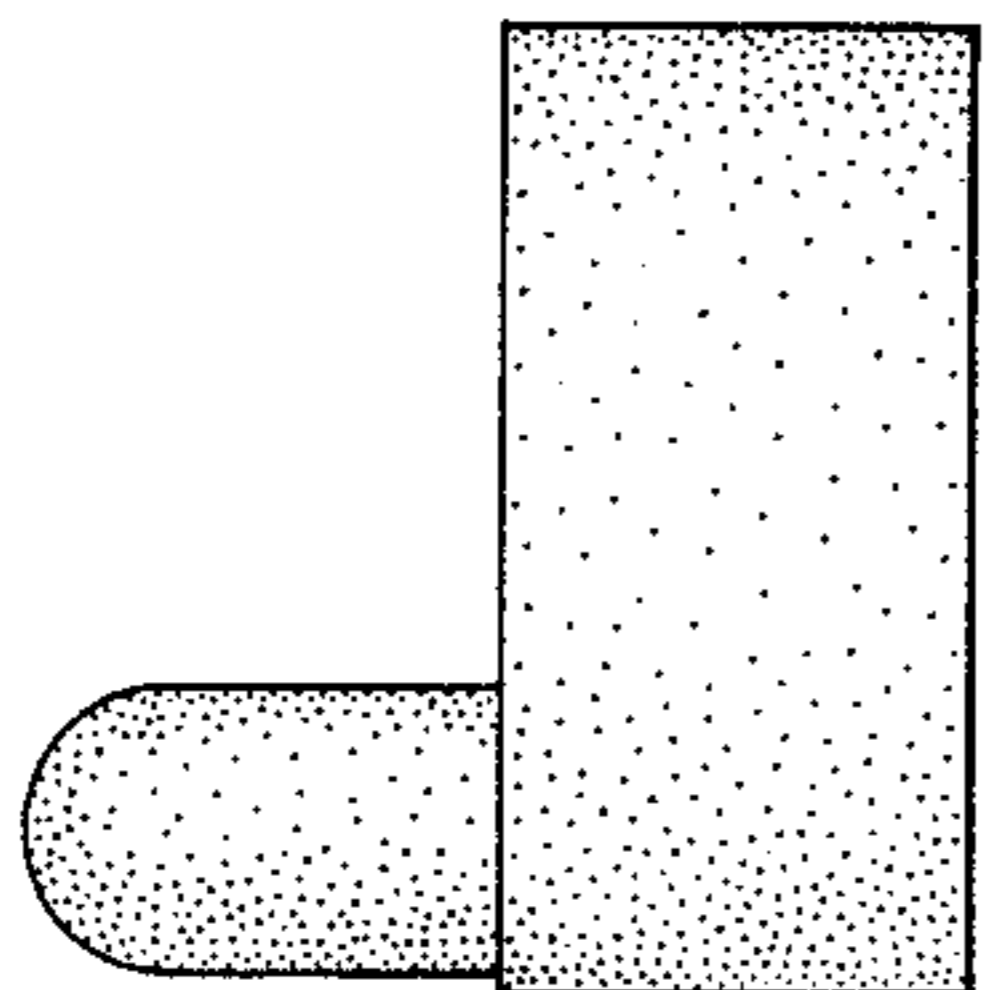

Fig. 6

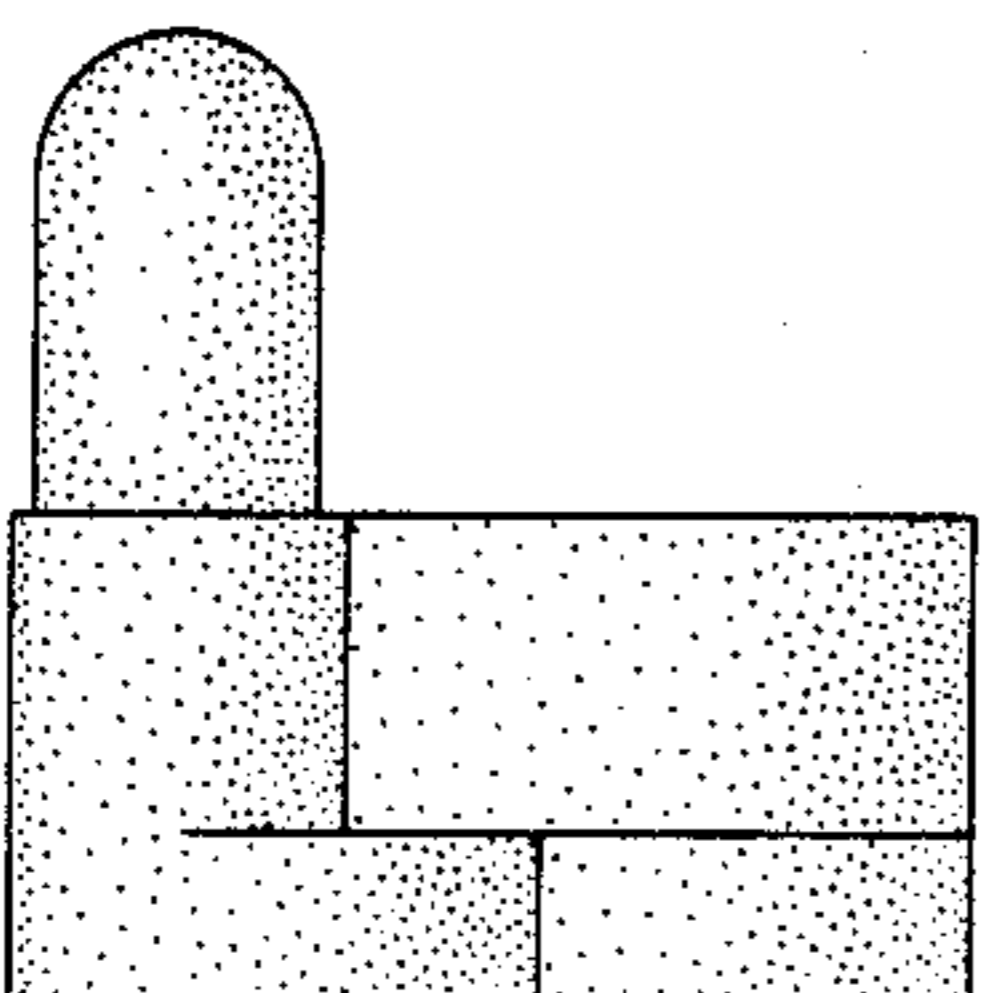
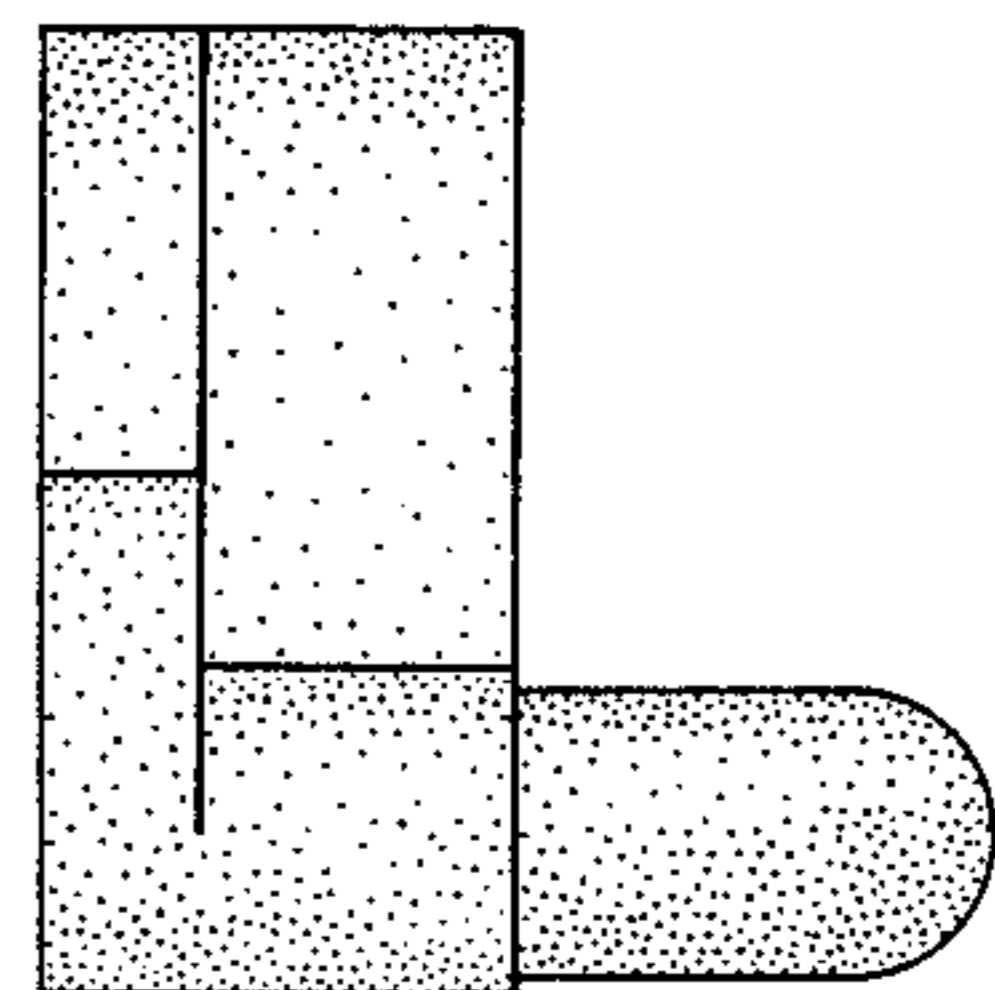

Fig. 7

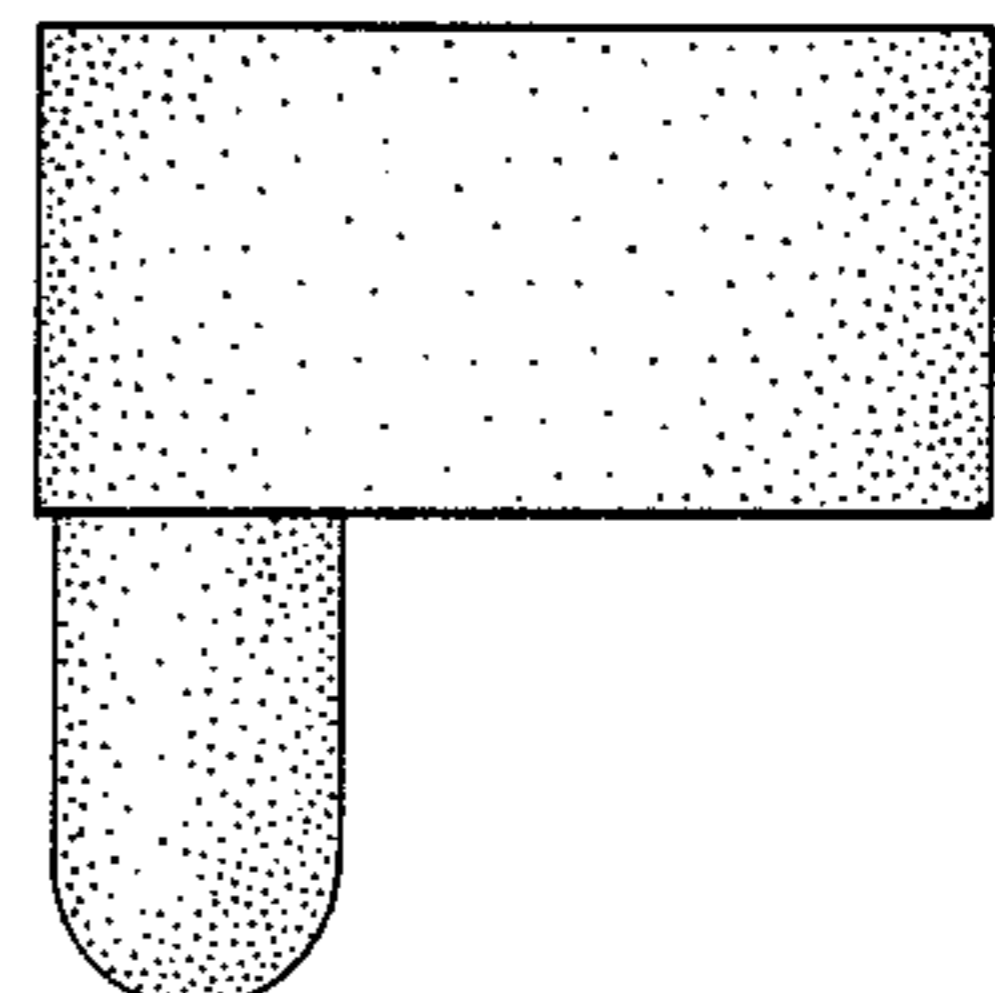

Fig. 8

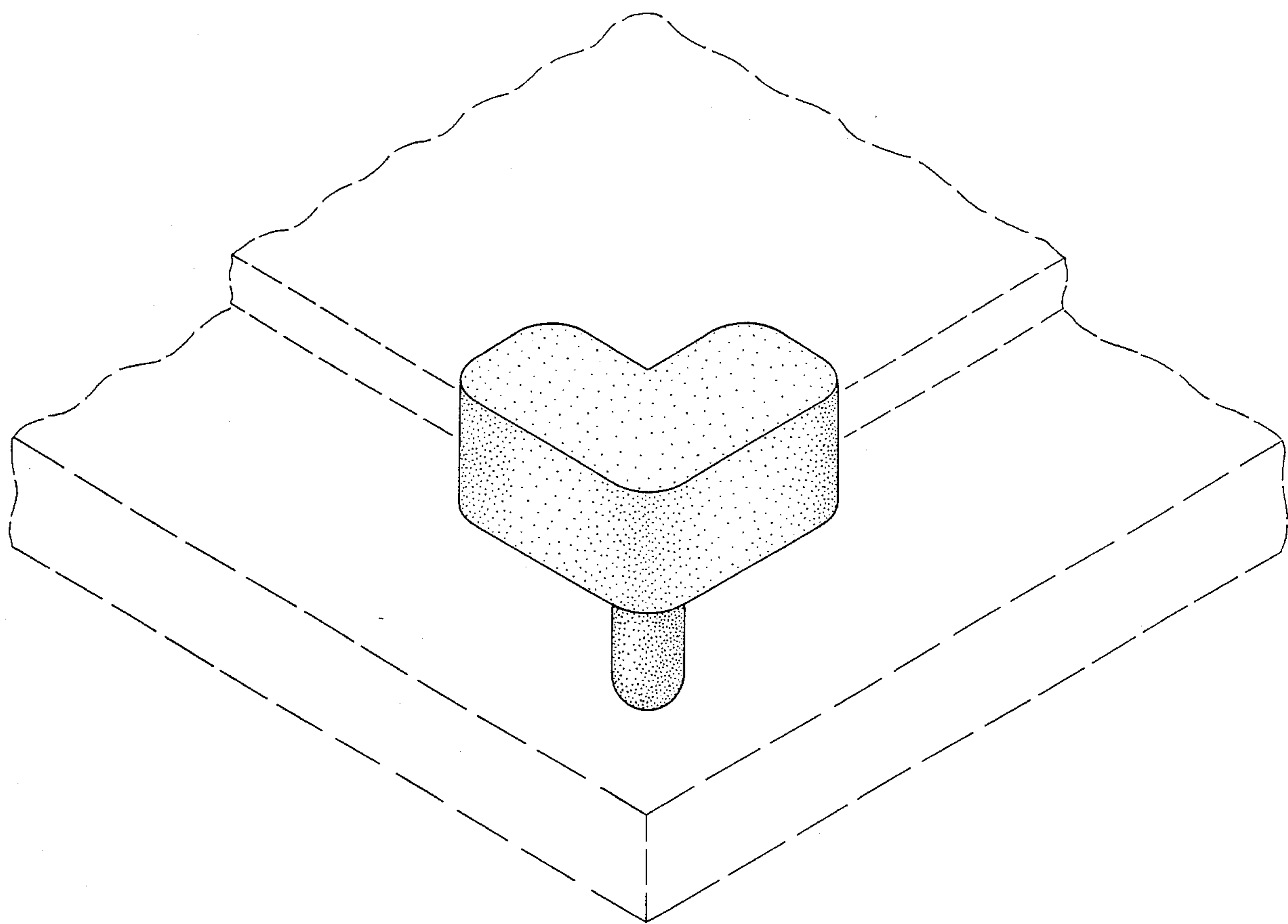

Fig. 9