

United States Patent [19]

Durham, Jr.

[11] Patent Number: **Des. 303,889**

[45] Date of Patent: **** Oct. 10, 1989**

[54] **HEADWALL UNIT FOR HOSPITAL ROOMS**

[75] Inventor: **Ira M. Durham, Jr., Houston, Tex.**

[73] Assignee: **The Methodist Hospital System, Houston, Tex.**

[*] Notice: The portion of the term of this patent subsequent to Apr. 4, 2006 has been disclaimed.

[**] Term: **14 Years**

[21] Appl. No.: **893,966**

[22] Filed: **Aug. 7, 1986**

[52] U.S. Cl. **D6/505**

[58] Field of Search D6/396, 397, 399, 436, D6/445, 505; D24/1.1, 4; 5/2 R, 60, 53 R, 280, 508

[56] **References Cited**

U.S. PATENT DOCUMENTS

D. 255,522 6/1980 Quigley D6/505
D. 266,806 11/1982 Lenger D6/506

394,806 12/1888 Augier 5/2 X
491,080 2/1893 Conant 5/53 R X
4,338,485 7/1982 Fullenkamp et al. .

FOREIGN PATENT DOCUMENTS

973539 12/1962 United Kingdom 5/2 R
2095986 10/1982 United Kingdom 5/53 R

Primary Examiner—Carmen H. Vales-Lado
Attorney, Agent, or Firm—Vinson & Elkins

[57] **CLAIM**

The ornamental design for a headwall unit for hospital rooms, as shown and described.

DESCRIPTION

FIG. 1 is a top perspective view of a headwall unit for hospital rooms showing my new design;
FIG. 2 is a bottom perspective view thereof;
FIG. 3 is a rear elevational view thereof;
FIG. 4 is a cross sectional view taken along line 4—4 of FIG. 3; and
FIG. 5 is a cross sectional view taken along line 5—5 of FIG. 3.

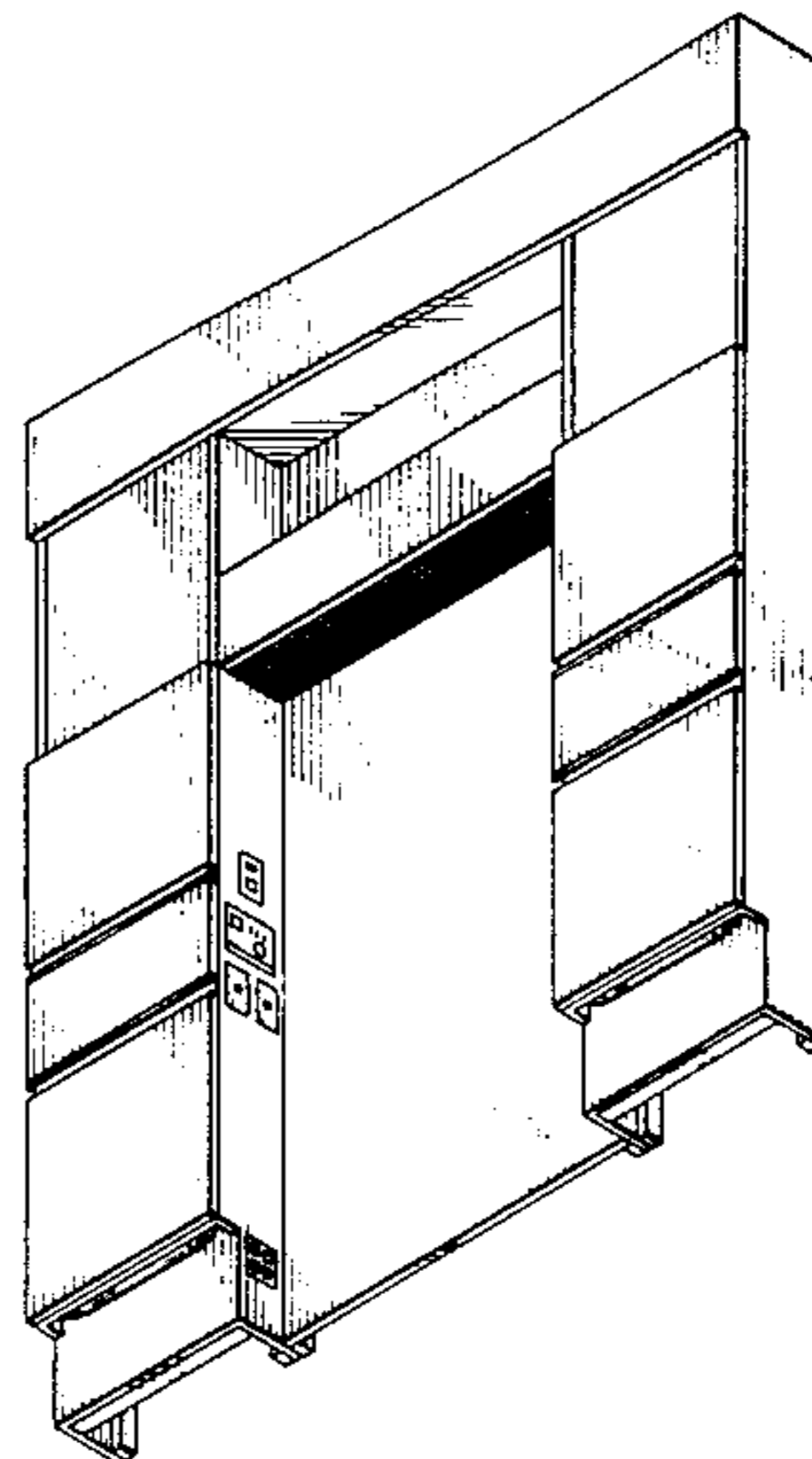
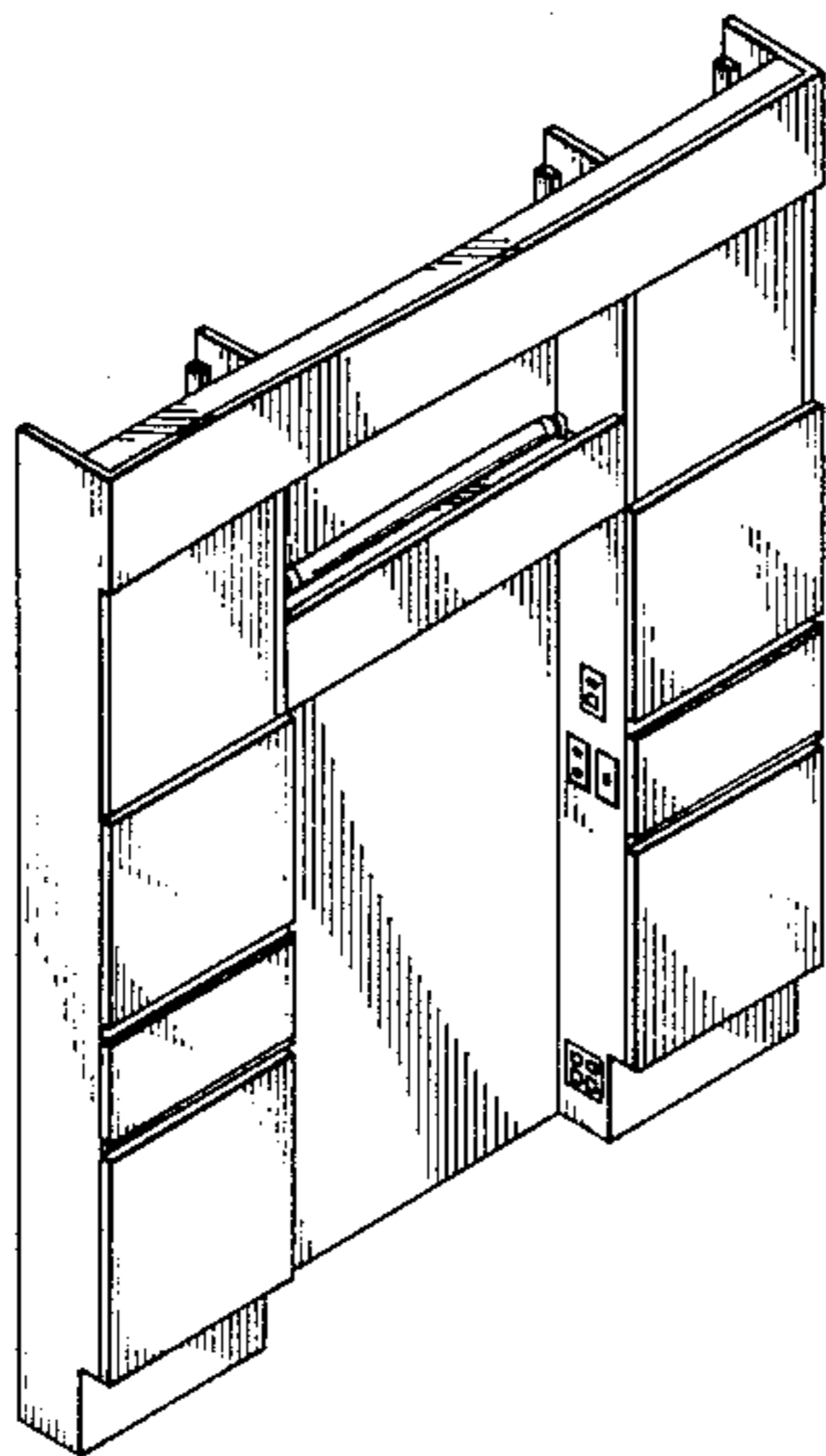

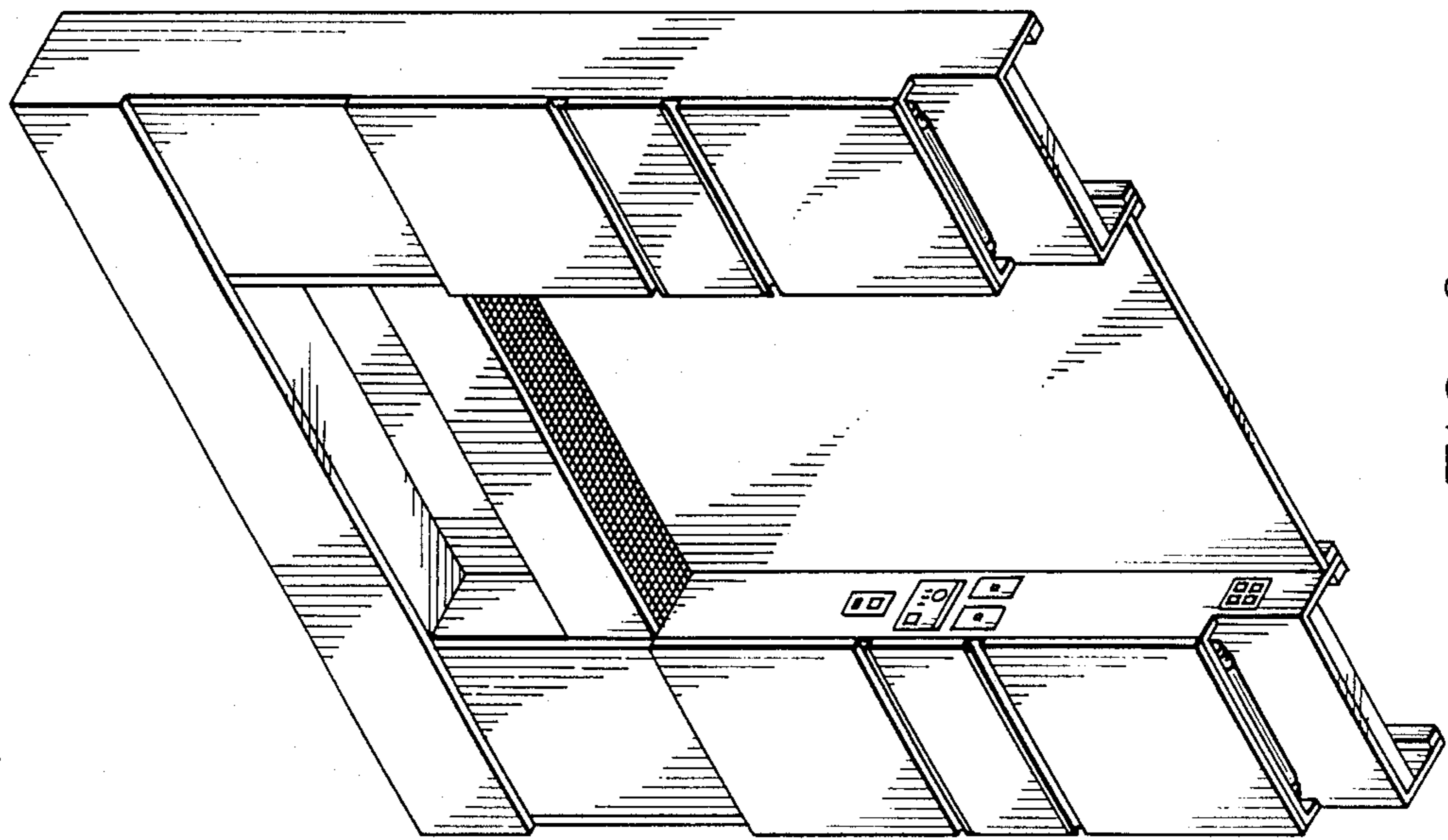

FIG. 2

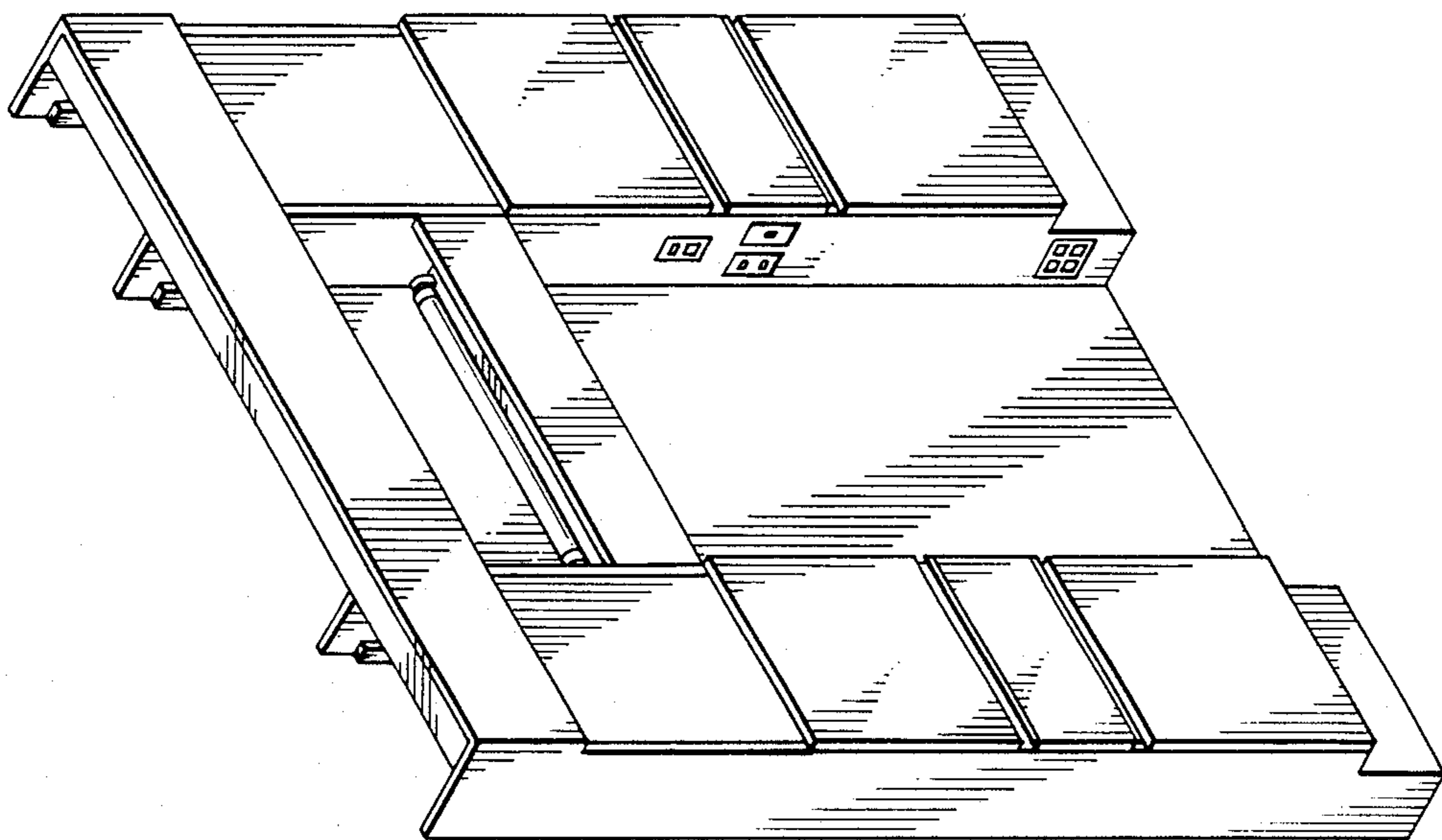

FIG. 1

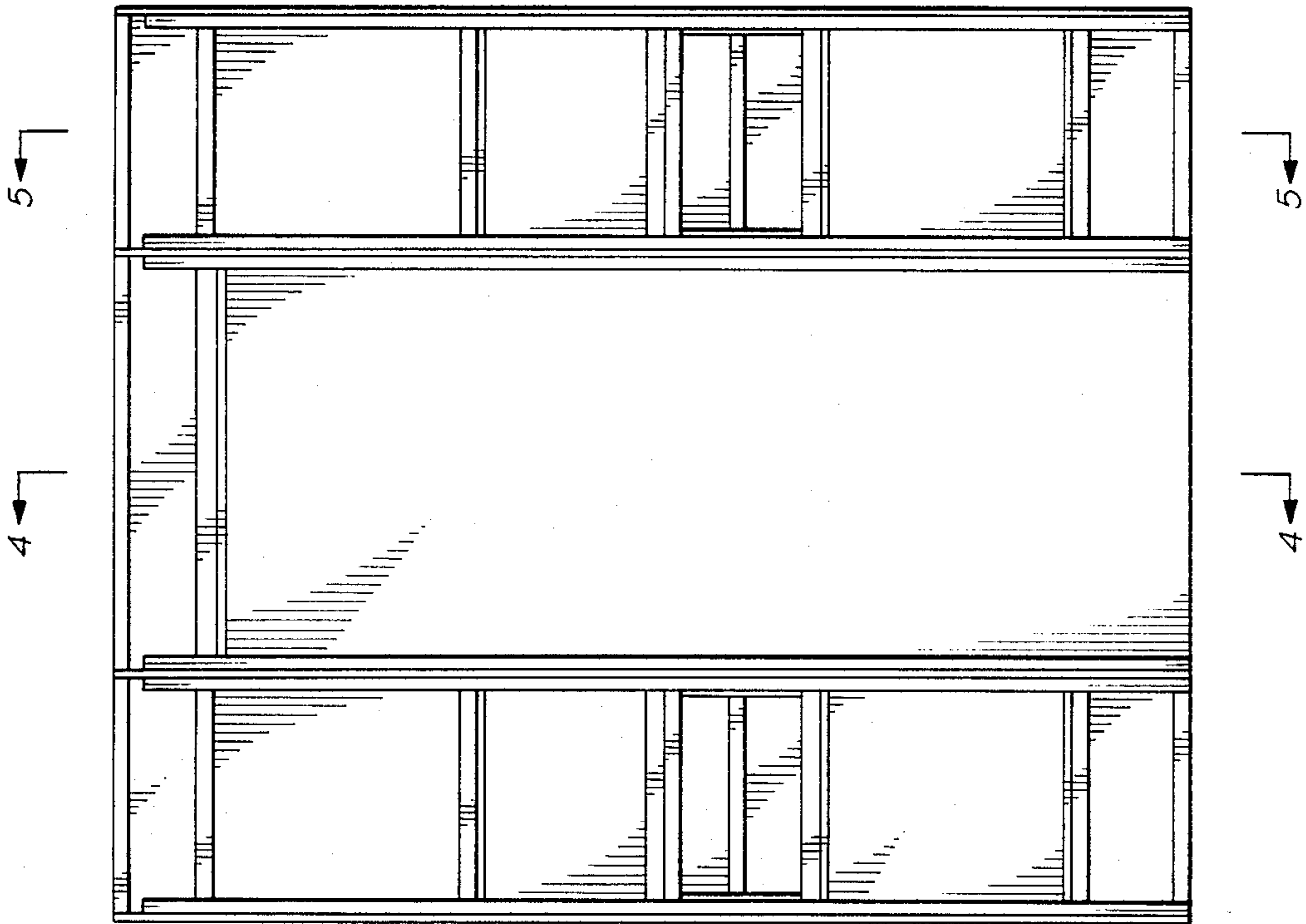

FIG. 3

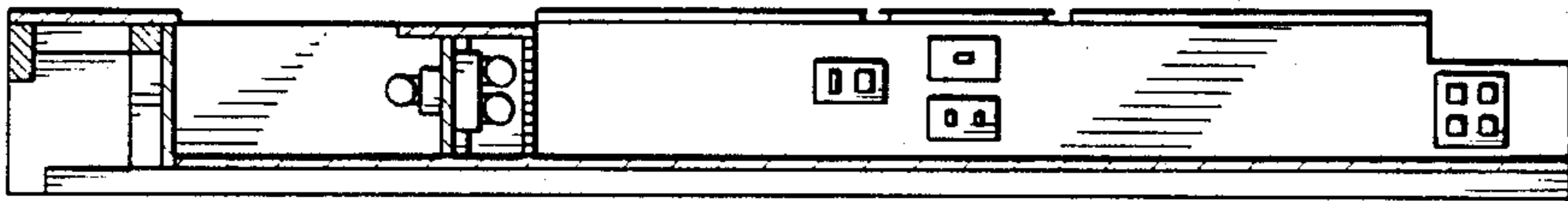

FIG. 4

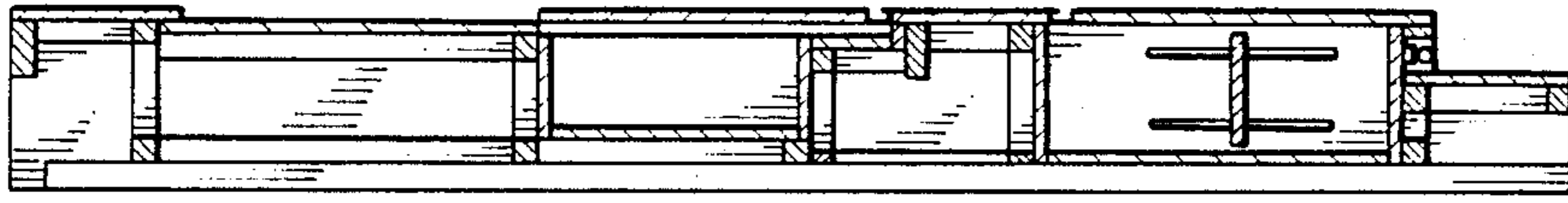

FIG. 5