

[54] **HOSIERY MATCHING CLAMP**

[76] **Inventor: Thurman Henderson, 402 W. 38th St., Indianapolis, Ind. 46208**

[\*\*] **Term: 14 Years**

[21] **Appl. No.: 10,801**

[22] **Filed: Feb. 4, 1987**

[52] **U.S. Cl. .... D32/64; D6/315; D6/326; D8/395**

[58] **Field of Search ..... D6/315, 326, 328; D8/395; D32/61, 64; 24/500, 502, 507, 508, 511; 211/113; 223/90, 91, 93, 96, 85, DIG. 2**

[56] **References Cited**

**U.S. PATENT DOCUMENTS**

D. 192,076	1/1962	Coughlin	.....	D32/61
D. 227,331	6/1973	Levitin	.....	D8/326
D. 231,310	4/1974	Burgher	.....	D32/61
D. 251,345	3/1979	Bigelow et al.	.....	D6/328
D. 295,811	5/1988	Larsson	.....	D6/326
D. 297,285	8/1988	Larsson	.....	D6/326
4,716,634	1/1988	Fan	.....	223/91

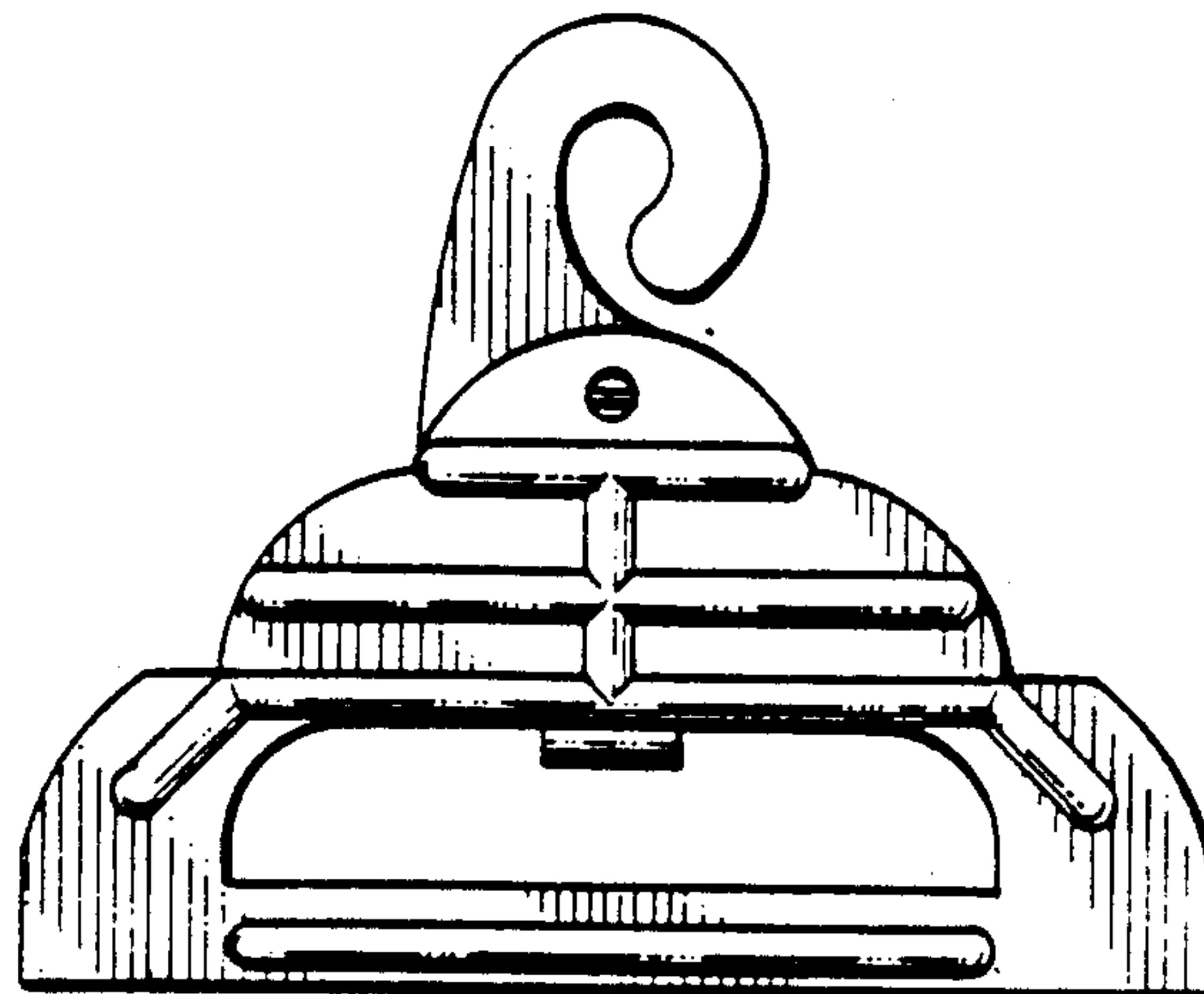
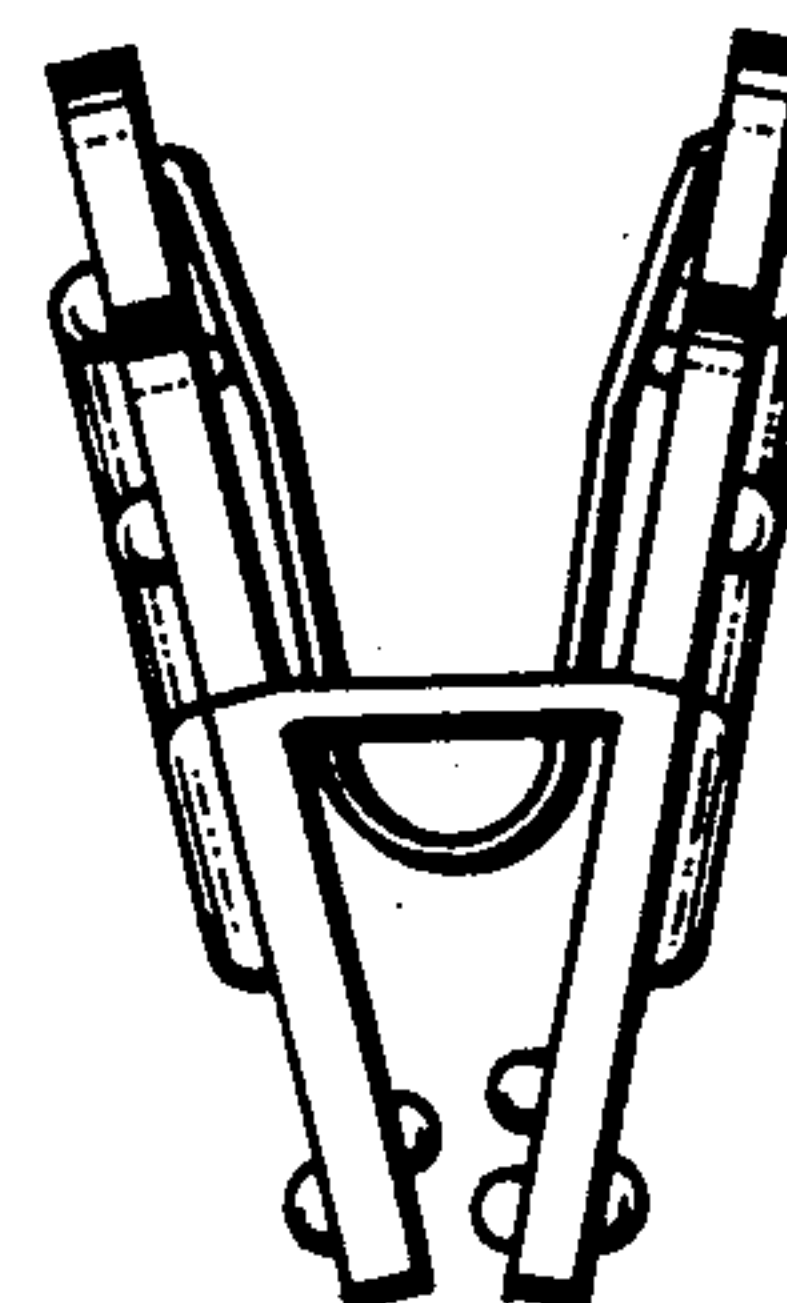
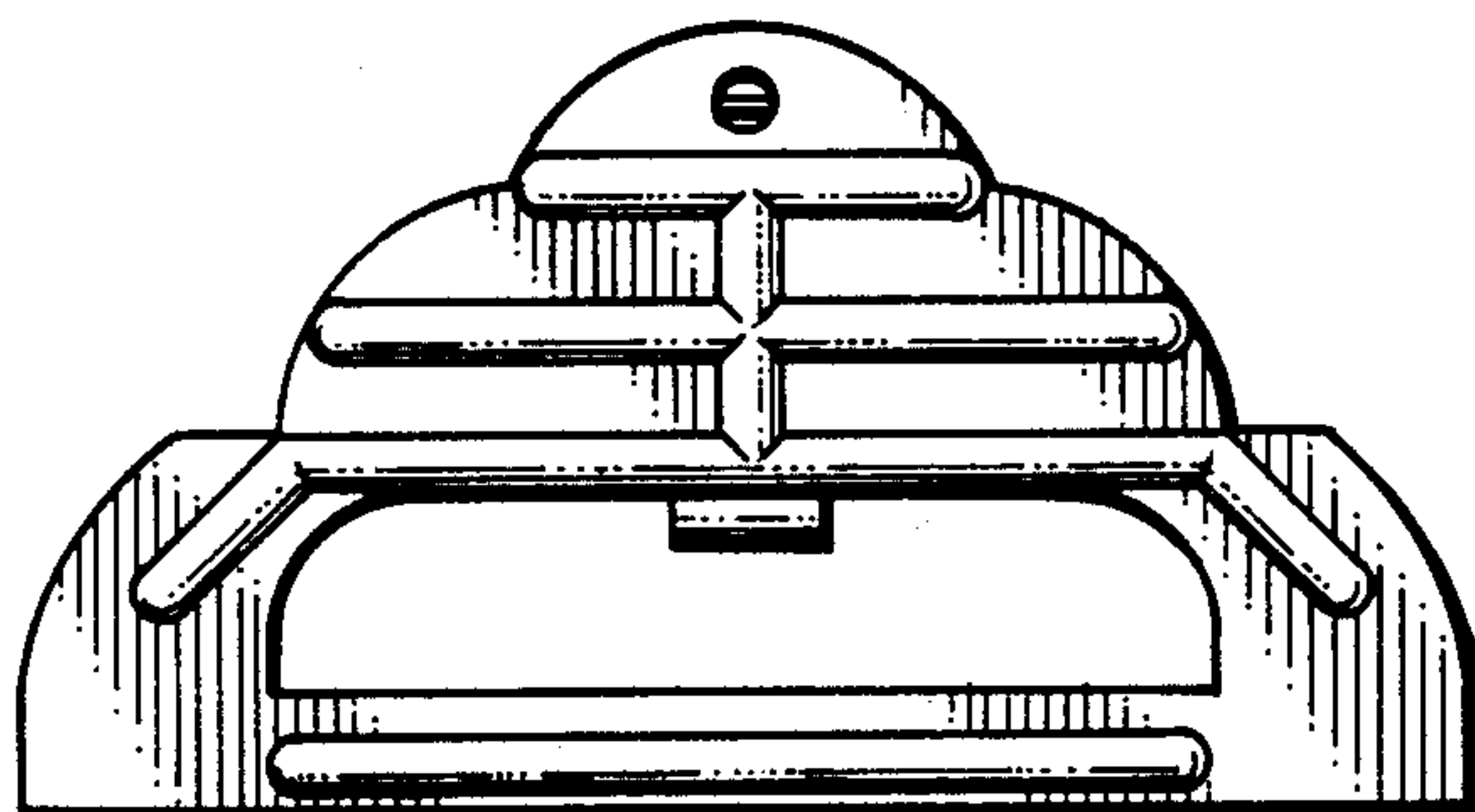
*Primary Examiner—B. J. Bullock  
 Attorney, Agent, or Firm—Robert A. Spray*

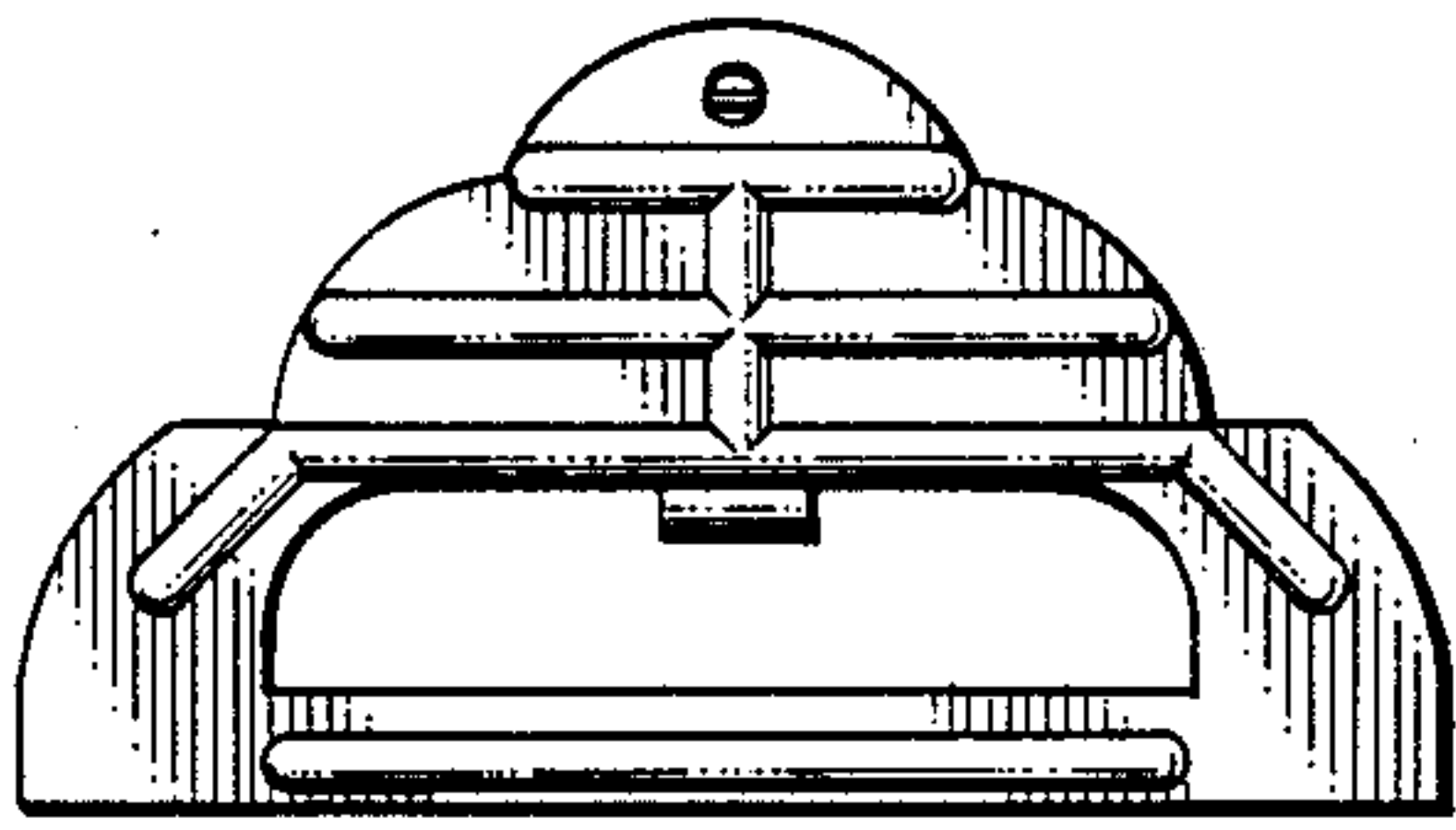
[57] **CLAIM**

The ornamental design for a hosiery matching clamp, as shown and described.

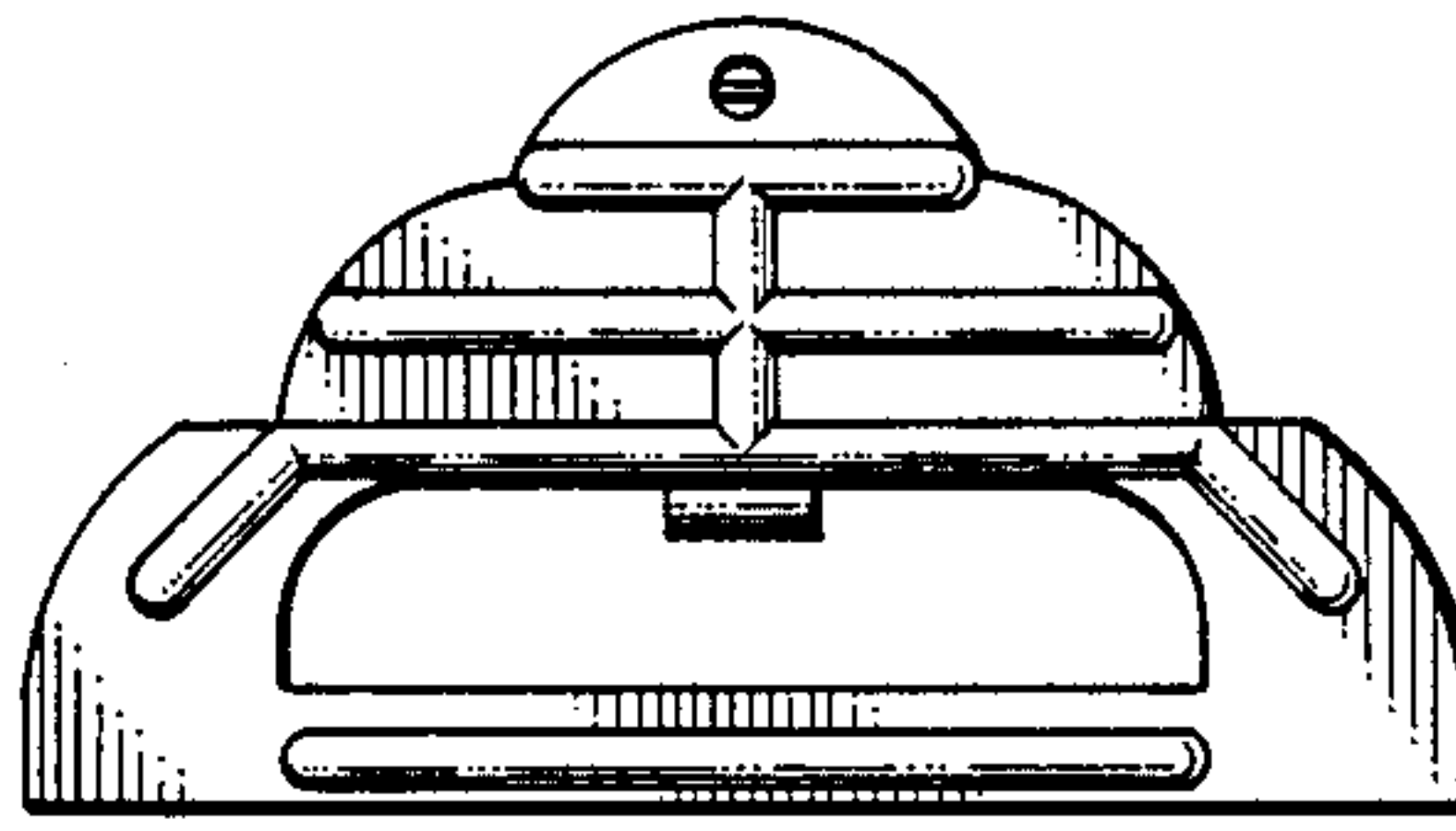
**DESCRIPTION**

FIG. 1 is a front elevational view of a hosiery matching clamp showing my new design;  
 FIG. 2 is a bottom plan view thereof;  
 FIG. 3 is a rear elevational view thereof;  
 FIG. 4 is a top plan view thereof;  
 FIG. 5 is an end elevational view thereof;  
 FIG. 6 is an elevational view of the end opposite that shown in FIG. 5;  
 FIG. 7 is a front elevational view of a second embodiment of the design of FIG. 1;  
 FIG. 8 is a bottom plan view of FIG. 7;  
 FIG. 9 is a rear elevational view of FIG. 7;  
 FIG. 10 is a top plan view of FIG. 7;  
 FIG. 11 is a right side elevational view of FIG. 7;  
 FIG. 12 is a left side elevational view of FIG. 7.

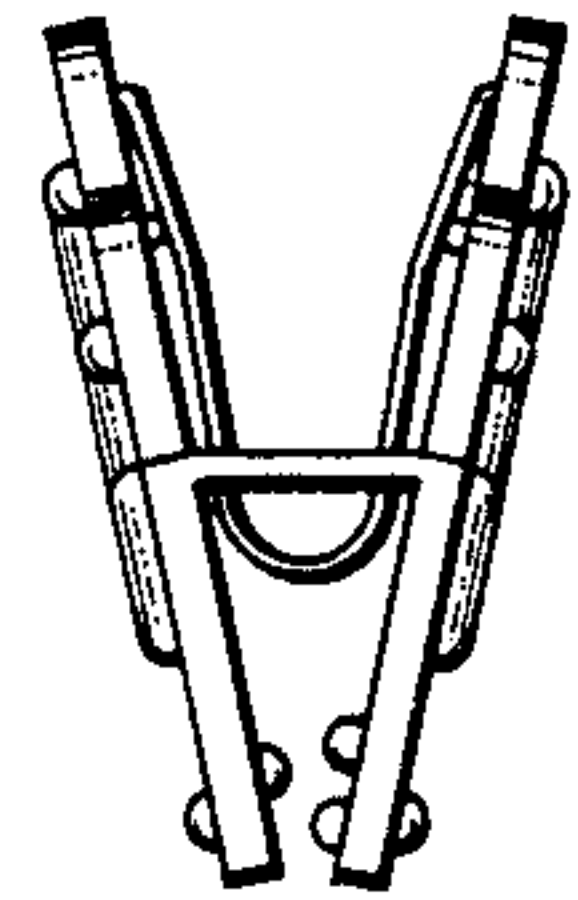




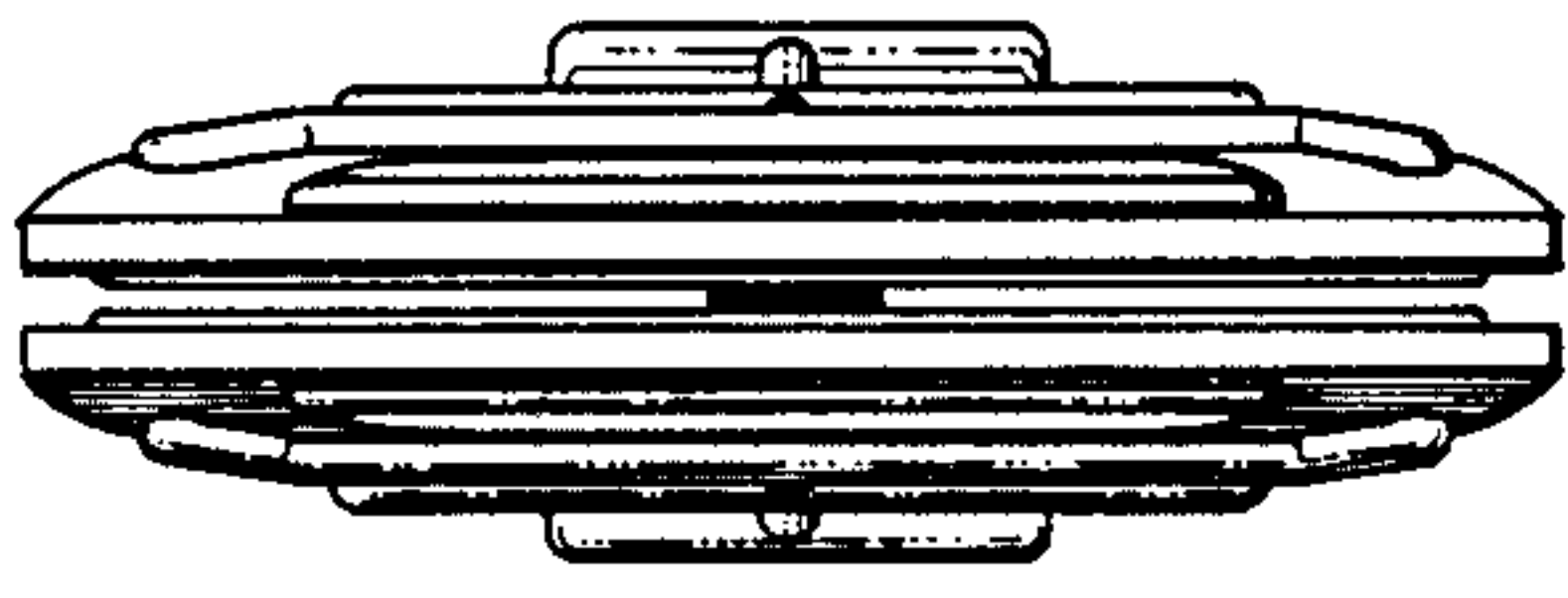
*FIG. 1*



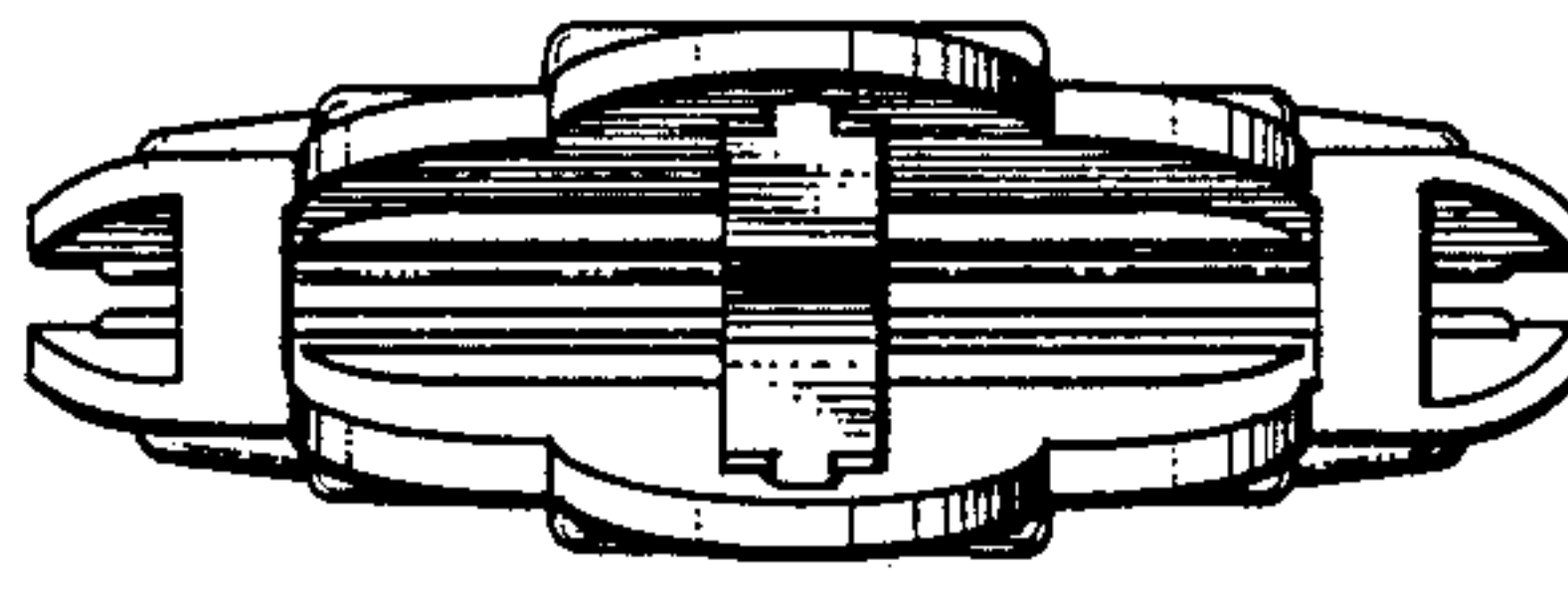
*FIG. 3*



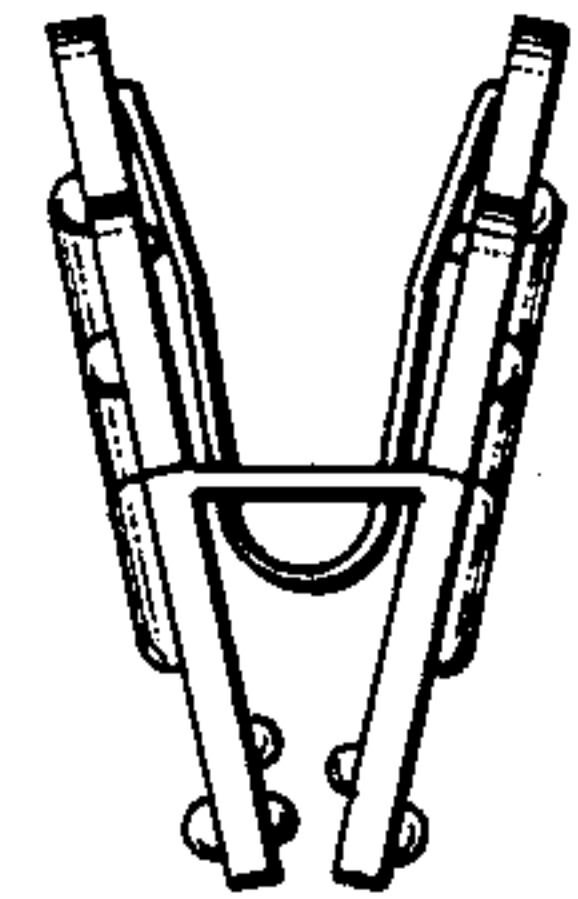
*FIG. 5*



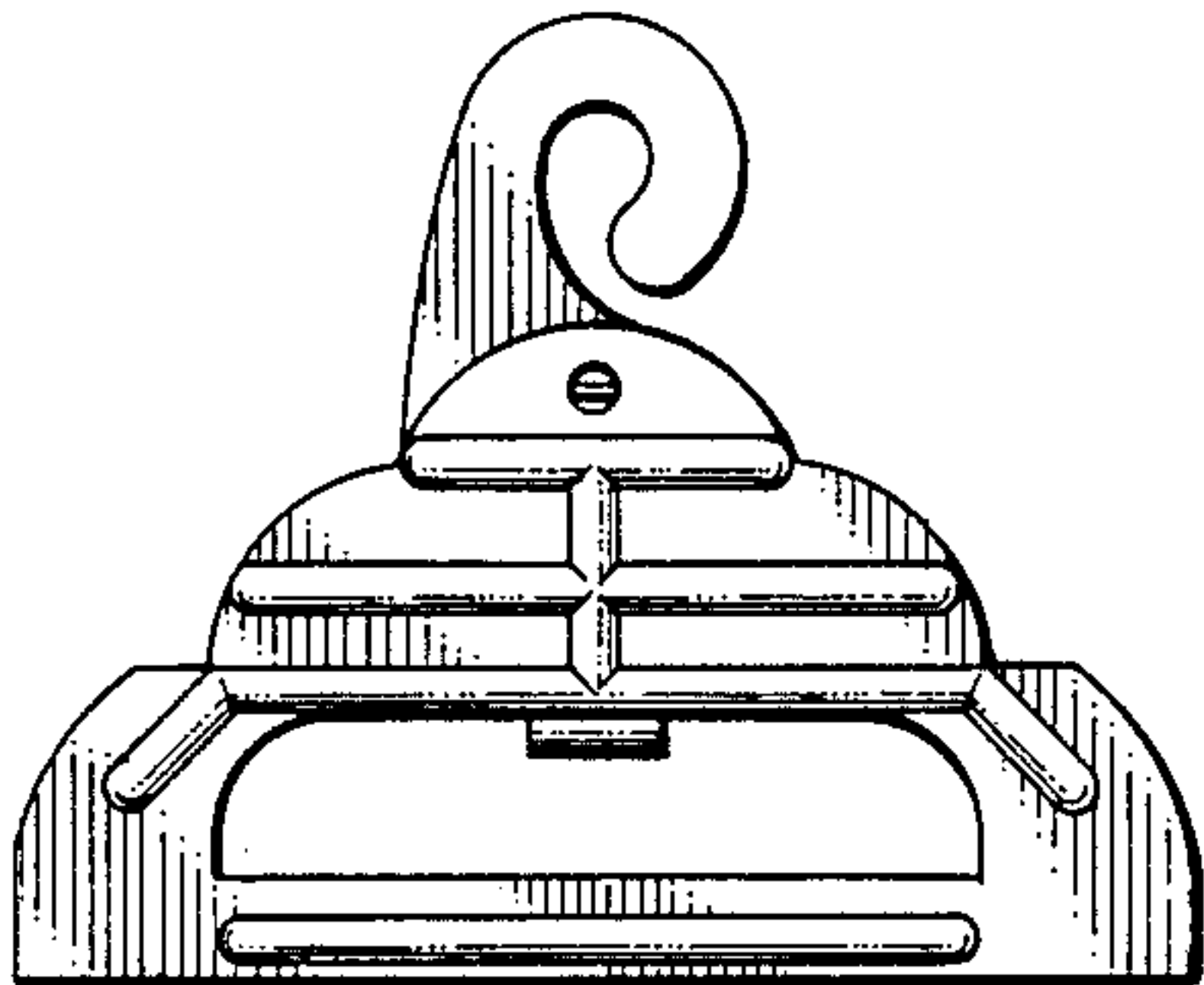
*FIG. 2*



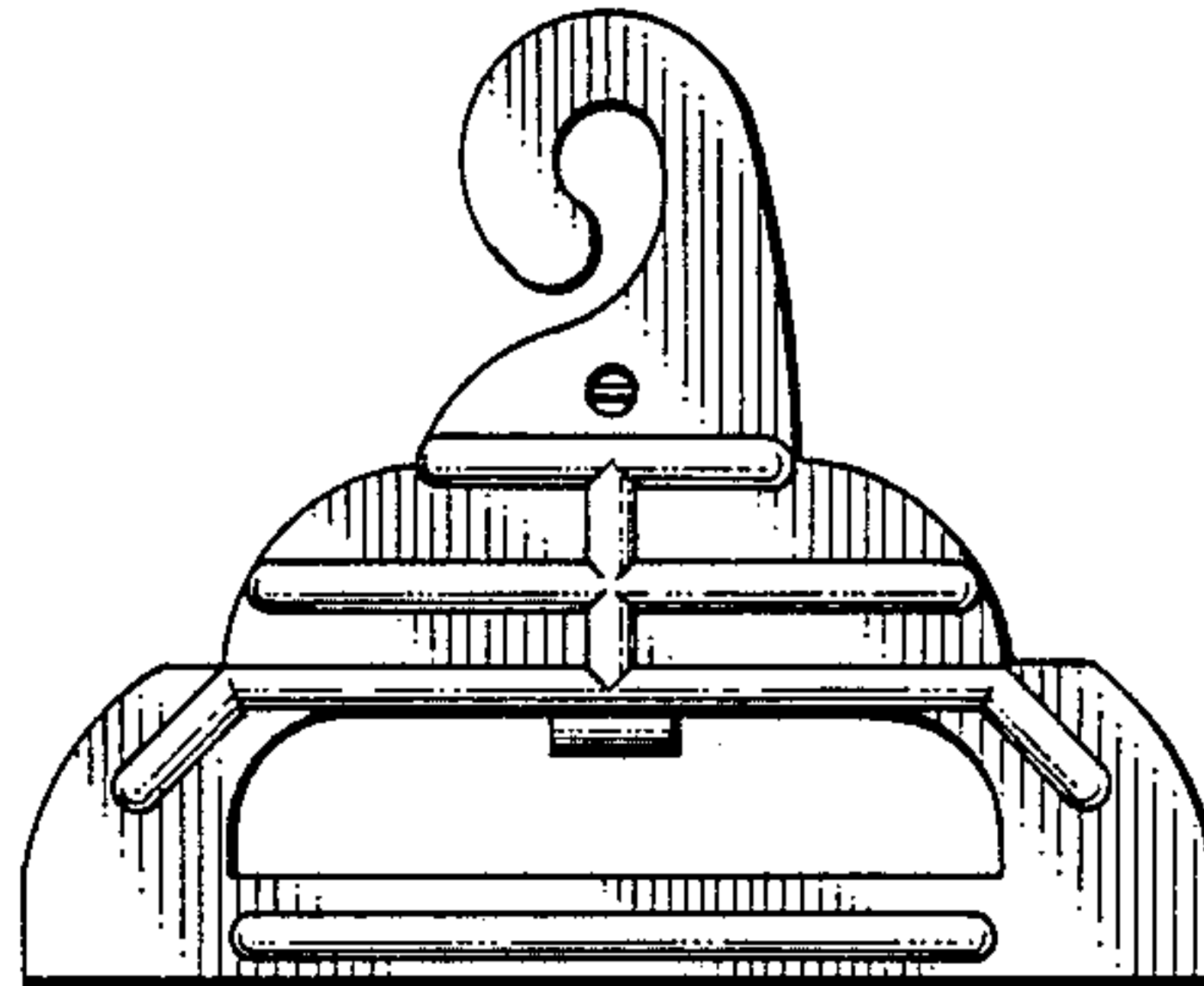
*FIG. 4*



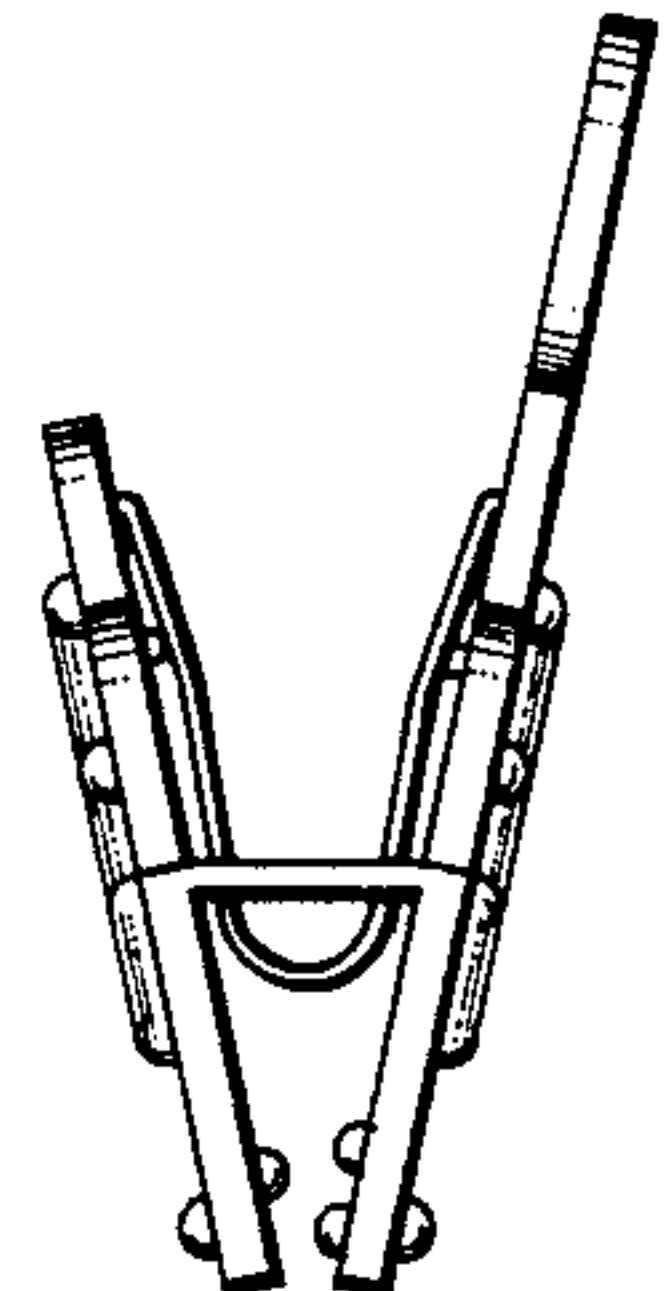
*FIG. 6*



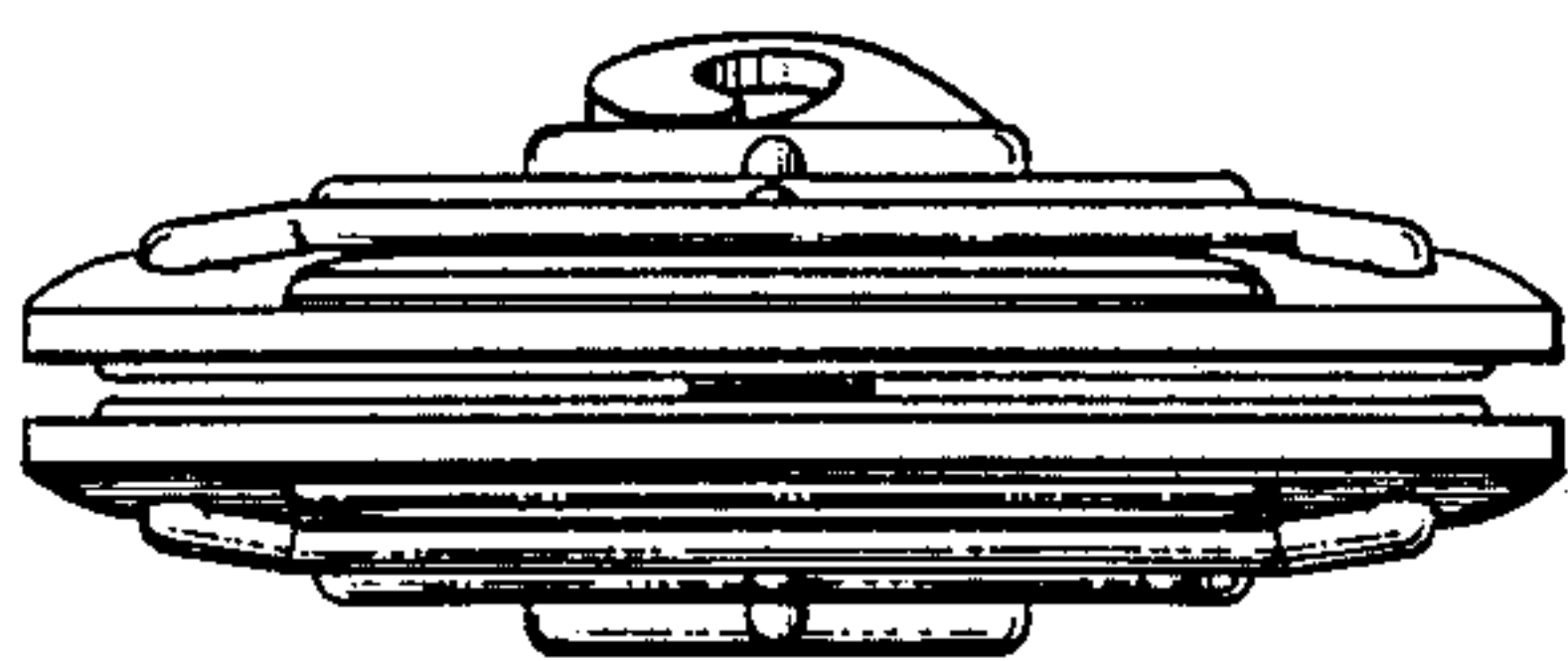
*FIG. 7*



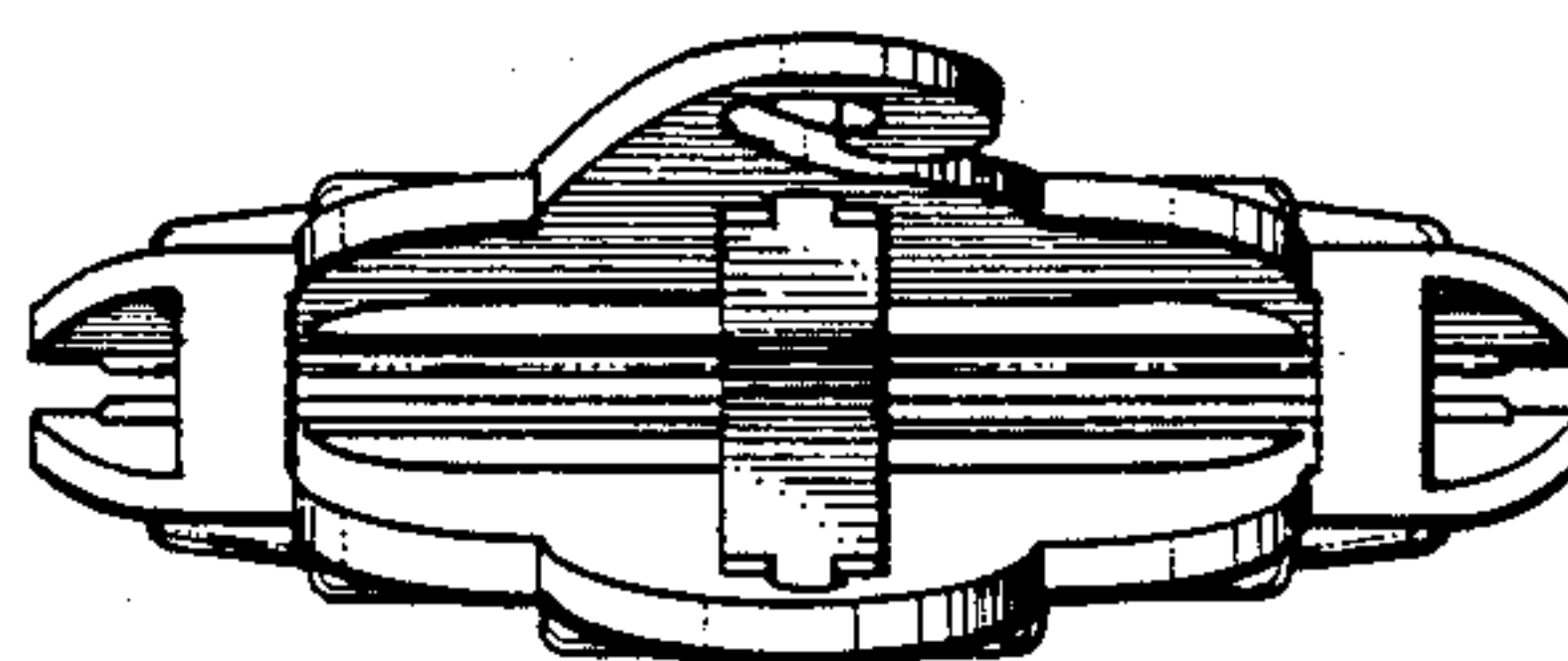
*FIG. 9*



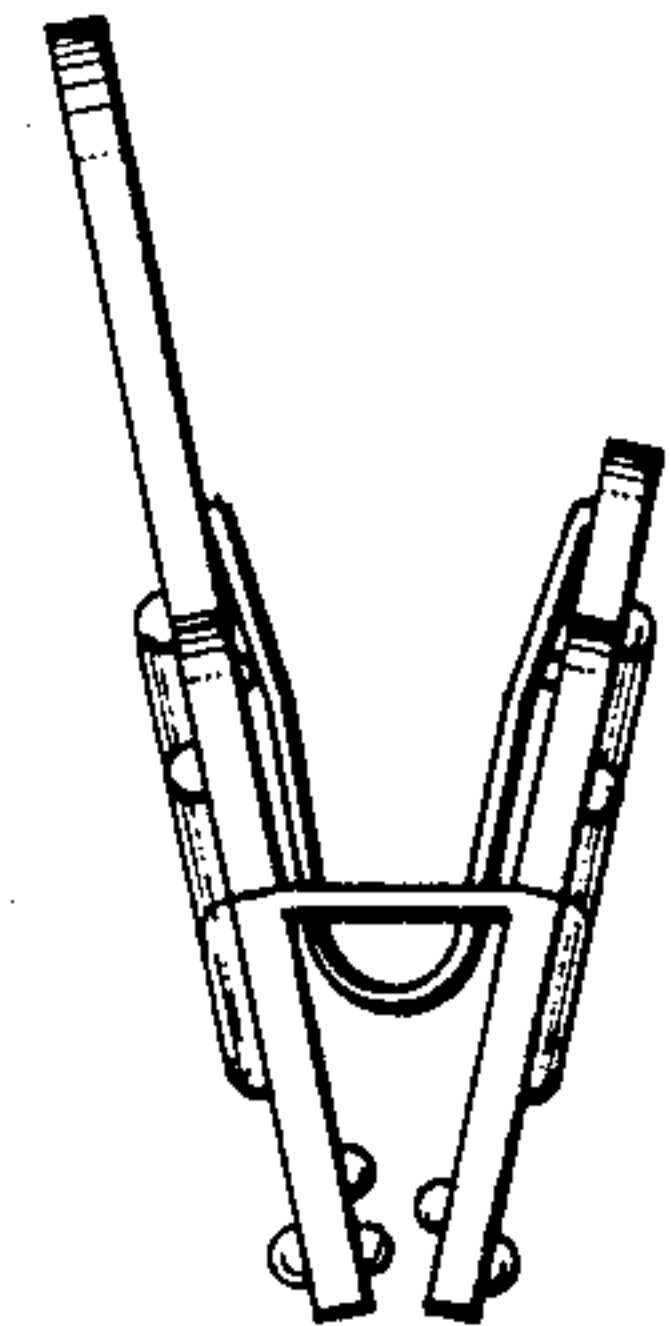
*FIG. 11*



*FIG. 8*



*FIG. 10*



*FIG. 12*