

United States Patent [19]

Maloney, II

[11] Patent Number: **Des. 303,824**

[45] Date of Patent: **** Oct. 3, 1989**

[54] **SOCCER GOAL**

[75] Inventor: **William J. Maloney, II**, East Aurora, N.Y.

[73] Assignee: **The Quaker Oats Company**, Chicago, Ill.

[**] Term: **14 Years**

[21] Appl. No.: **895,894**

[22] Filed: **Aug. 12, 1986**

[52] U.S. Cl. **D21/200**

[58] Field of Search D21/6, 59, 200; D25/66, D25/62; 40/607; 182/181; 211/206; 272/62, 64; 273/127 B, 127 D, 127 R, 179 E, 181 J, 402, 404, 405, 386, 389

[56] **References Cited**

U.S. PATENT DOCUMENTS

D. 261,667 11/1981 Griggs D21/6

3,197,208 7/1965 Makar 273/181
4,245,843 1/1981 Griggs 273/1 B

FOREIGN PATENT DOCUMENTS

1158271 12/1983 Canada 273/127 R

Primary Examiner—Melvin B. Feifer
Assistant Examiner—William Krawczewicz
Attorney, Agent, or Firm—Cumpston & Shaw

[57] **CLAIM**

The ornamental design for a soccer goal, as shown and described.

DESCRIPTION

FIG. 1 is a front elevational view of a soccer goal showing my new design;
FIG. 2 is a right-side elevational view thereof;
FIG. 3 is a left-side elevational view thereof;
FIG. 4 is a top plan view thereof;
FIG. 5 is a rear elevational view thereof; and
FIG. 6 is a bottom plan view thereof.

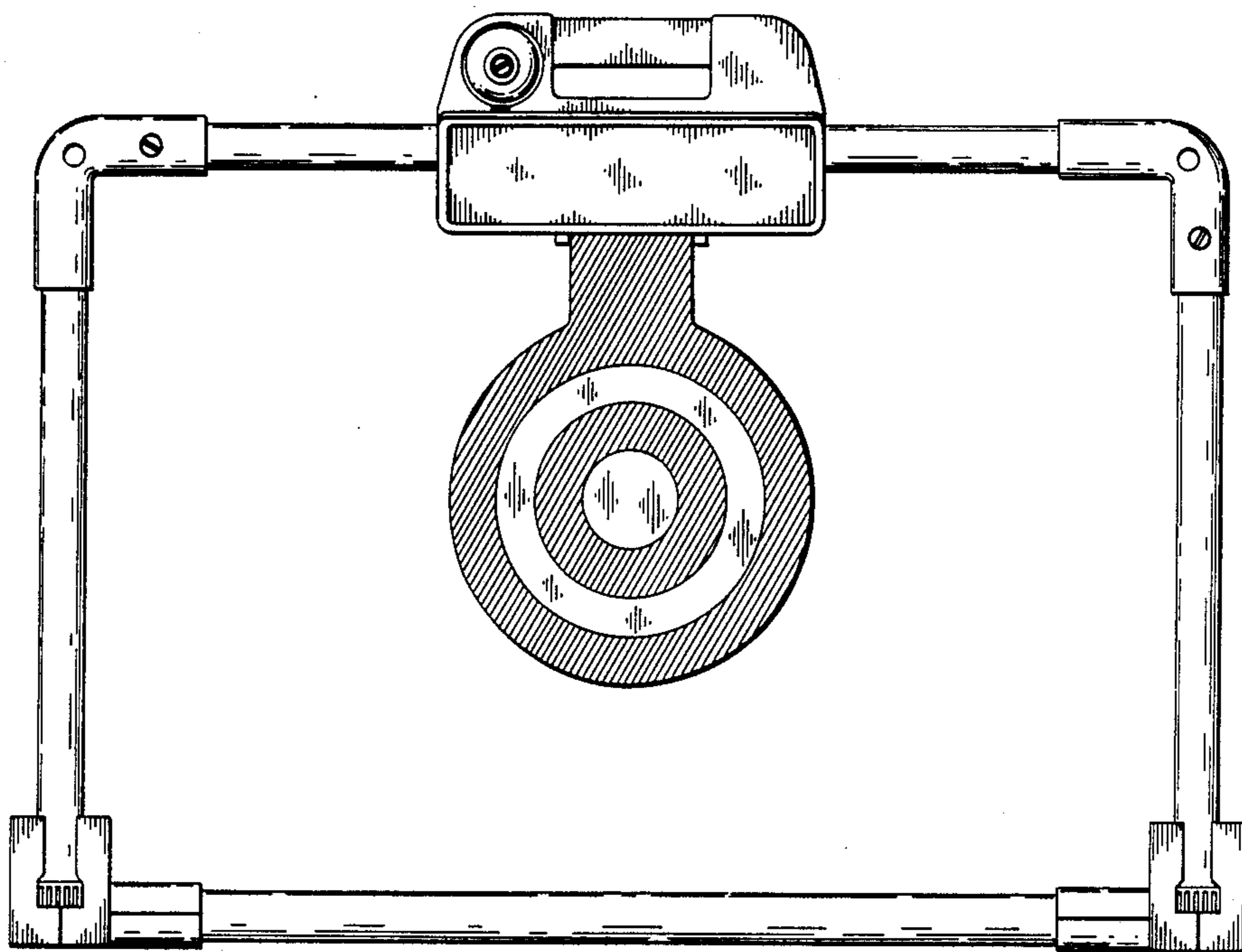

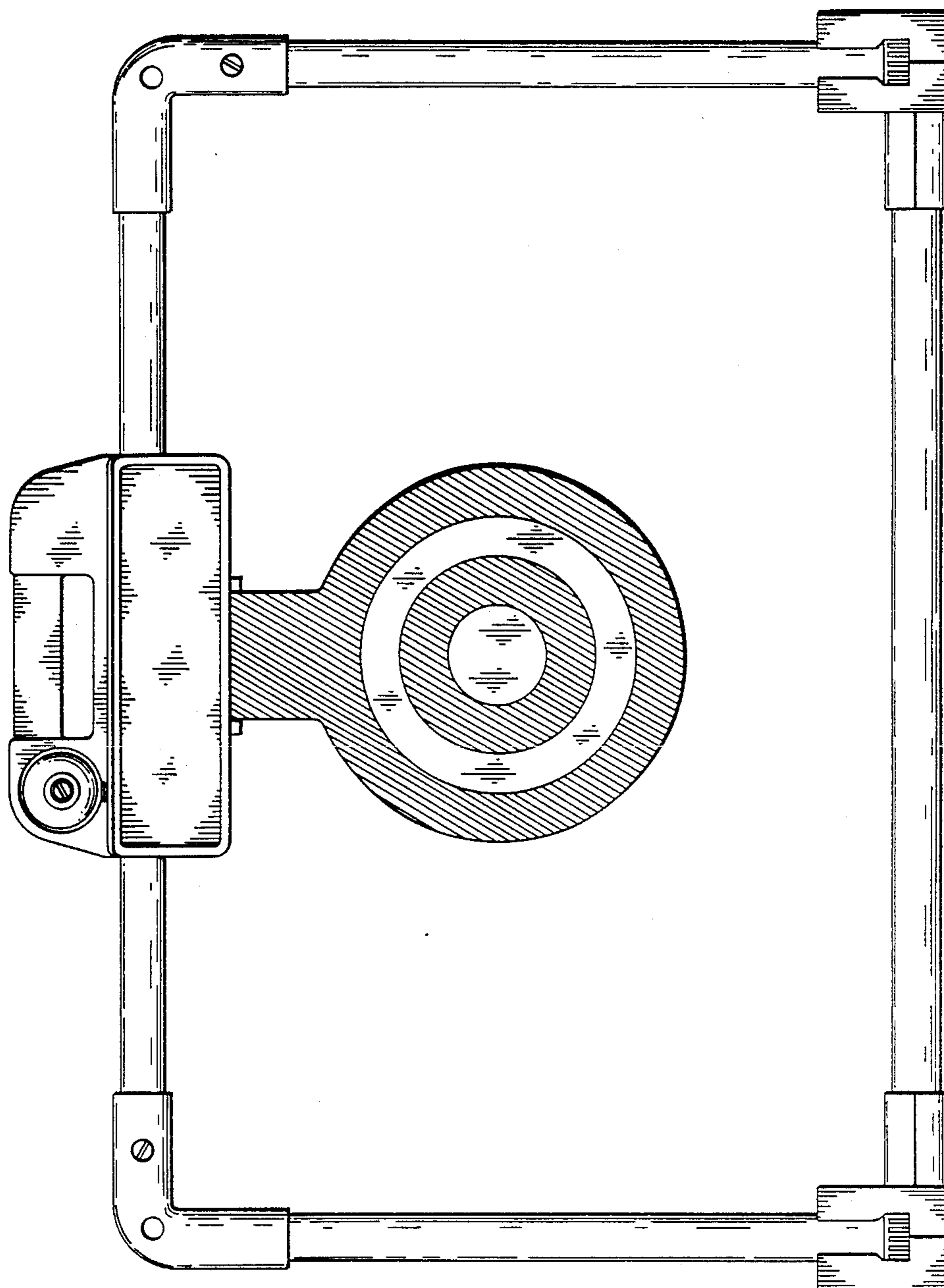

FIG. 1

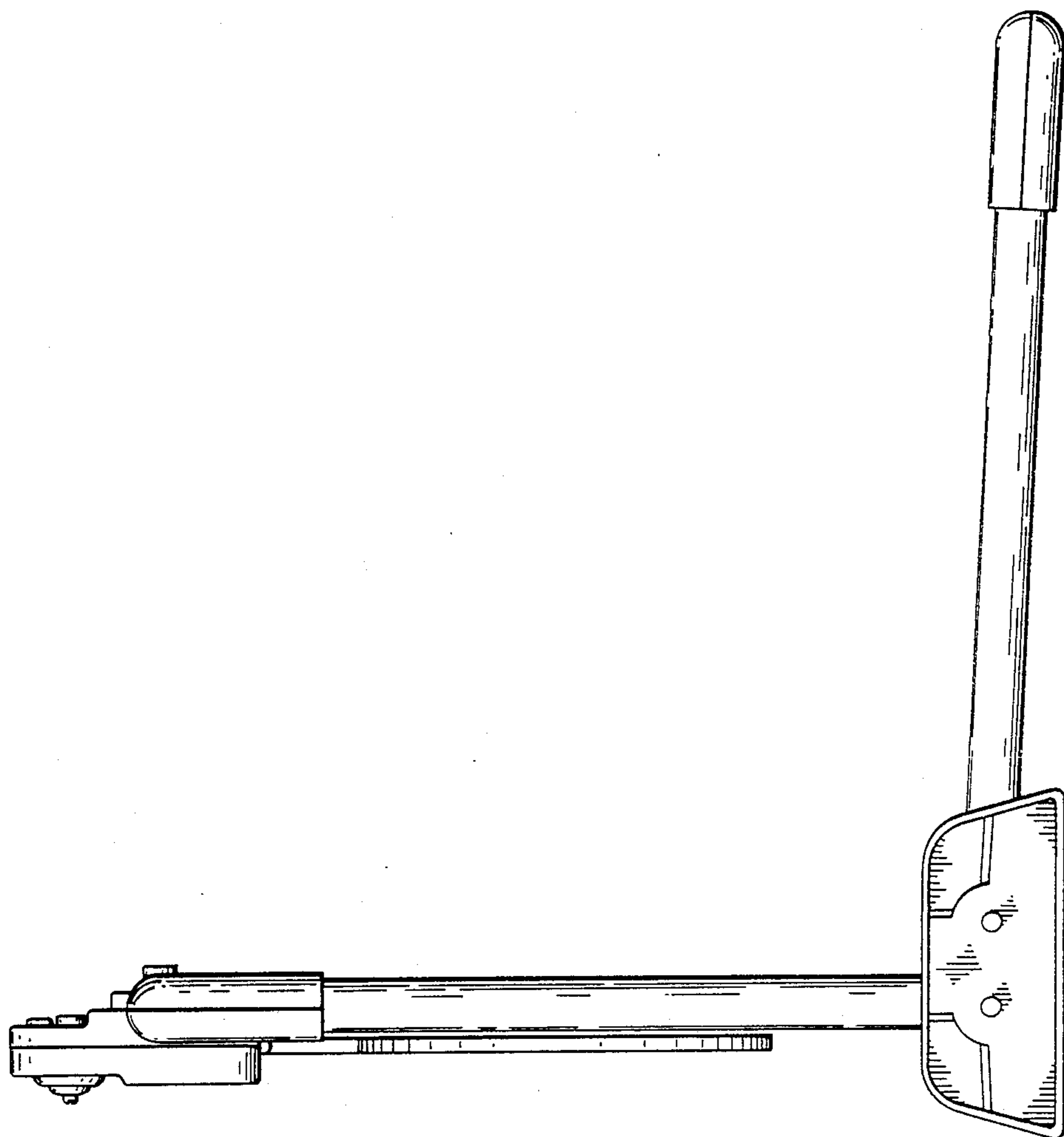

FIG. 2

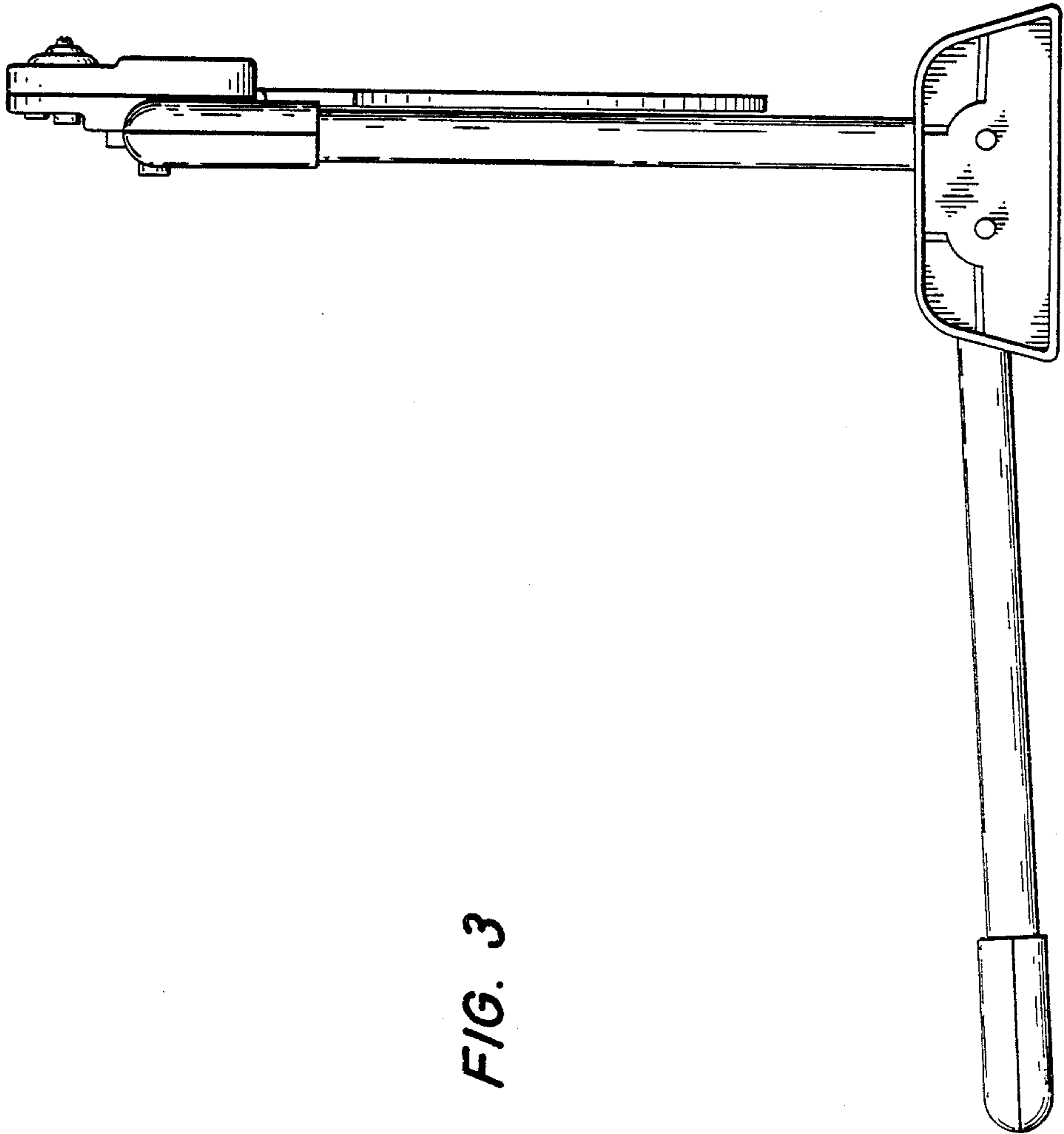

FIG. 3

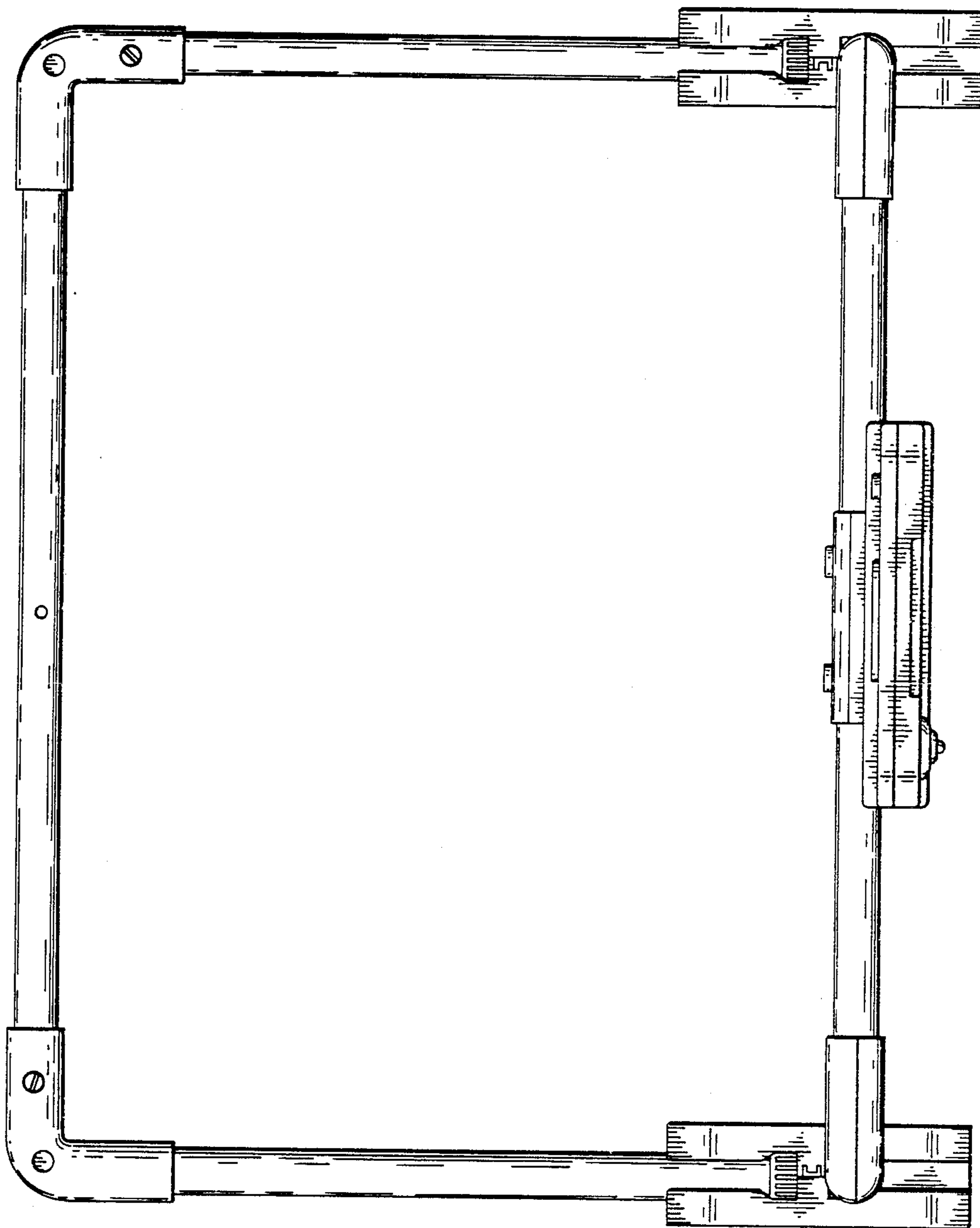

FIG. 4

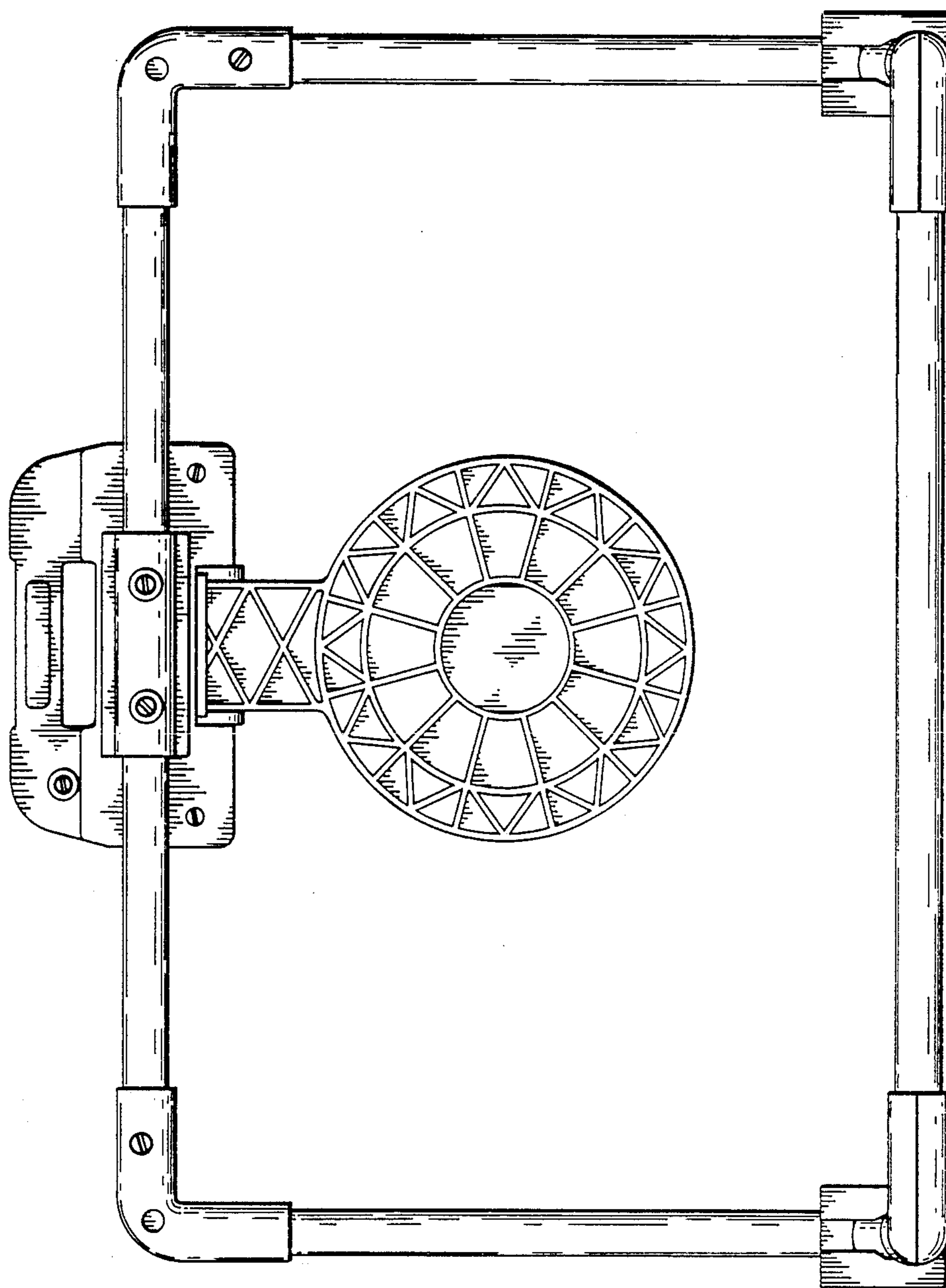

FIG. 5

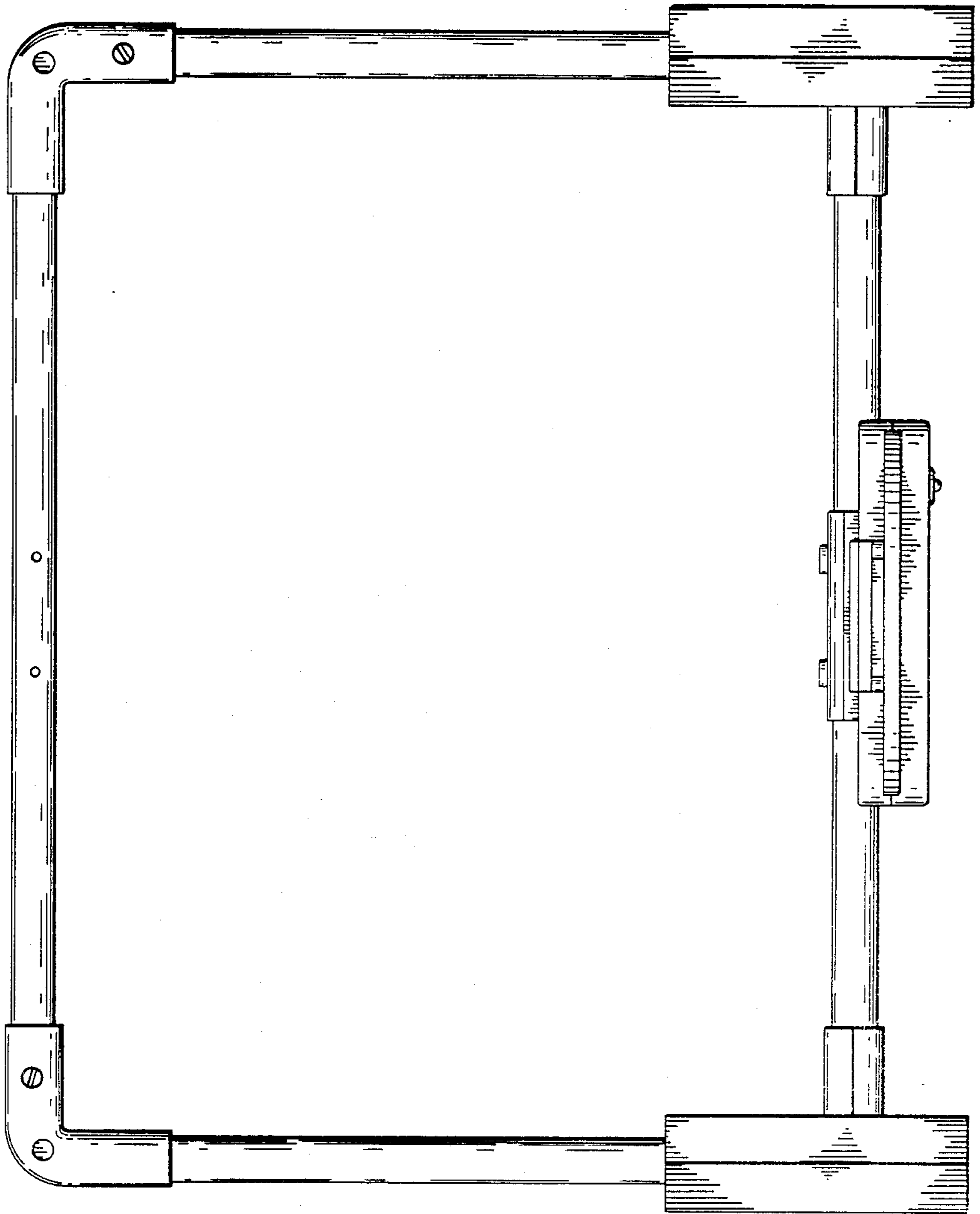

FIG. 6