

[54] **DESK TOP ORGANIZER TRAY**

[75] Inventors: **Kenneth C. Foran, Wooster; Thomas J. David, Worthington, both of Ohio**

[73] Assignee: **Rubbermaid Incorporated, Wooster, Ohio**

[**] Term: **14 Years**

[21] Appl. No.: **894,244**

[22] Filed: **Aug. 7, 1986**

[52] U.S. Cl. **D19/77; D19/92; D19/95**

[58] Field of Search **D19/65, 75, 76, 77, D19/78, 86, 92; D6/511, 574; D7/37, 38; D34/40, 46; 206/214, 425, 503, 505, 511; 211/13, 50, 55, 126**

[56] **References Cited**

U.S. PATENT DOCUMENTS

- D. 285,998 10/1986 Langensipen D7/38
- D. 287,788 1/1987 Shames et al. D19/76

OTHER PUBLICATIONS

Product Catalog page—Eldon Office Products, 1130 East 230th St., Carson, CA 90745, date—1986.

Product Catalog p. 11, Lion Office Products, Inc., 401 W. Alondra Blvd., Gardena, CA 90248, publ.—1986.

Primary Examiner—Bruce W. Dunkins

Assistant Examiner—Martha Thompson

Attorney, Agent, or Firm—Richard B. O'Planick

[57] **CLAIM**

The ornamental design for a desk top organizer tray, as shown.

DESCRIPTION

FIG. 1 is a front perspective view of a desk top organizer tray showing our new design;

FIG. 2 is a top plan view;

FIG. 3 is a front elevational view;

FIG. 4 is a left side elevational view;

FIG. 5 is a rear elevational view, and

FIG. 6 is a bottom plan view thereof.

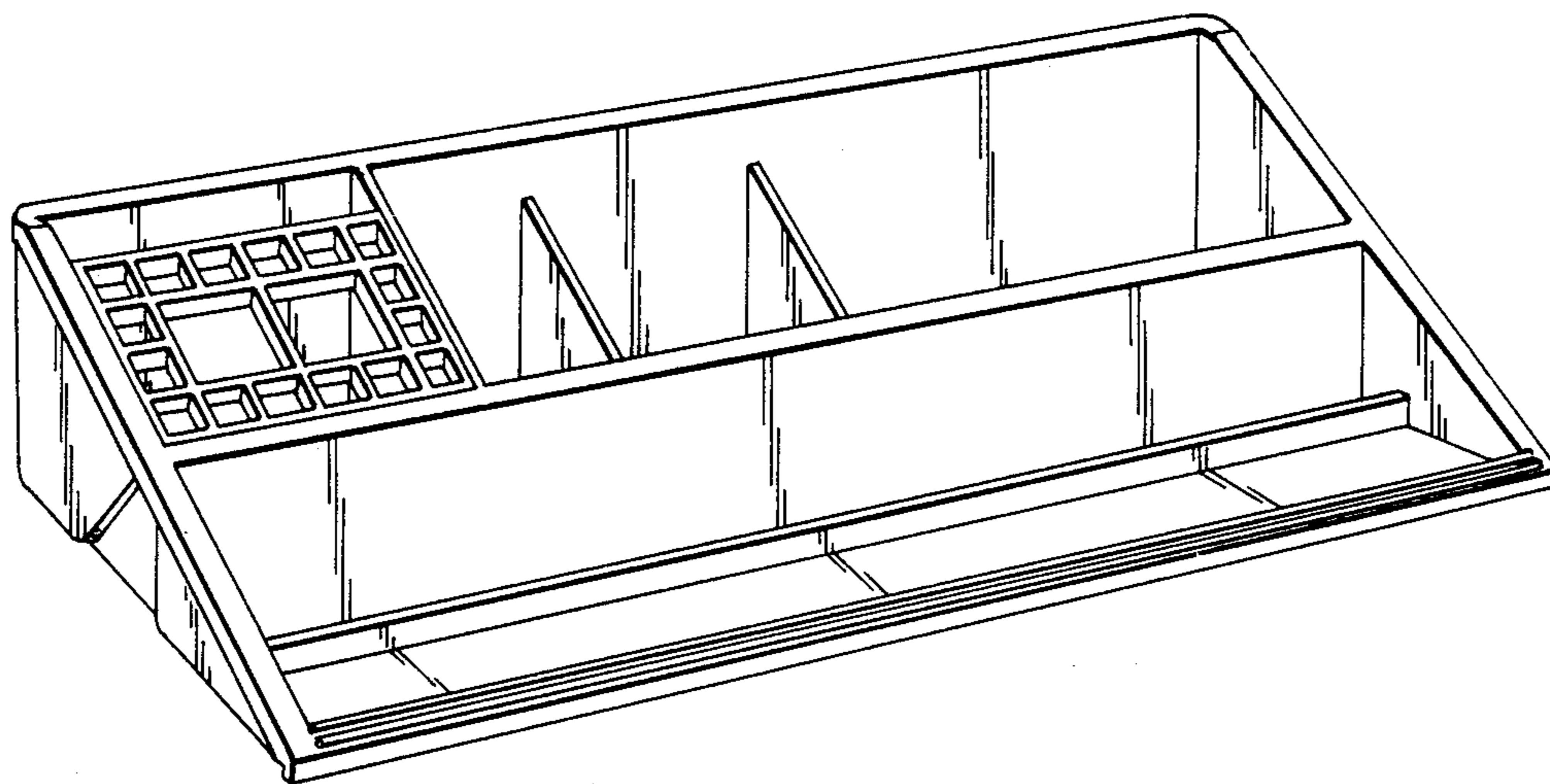

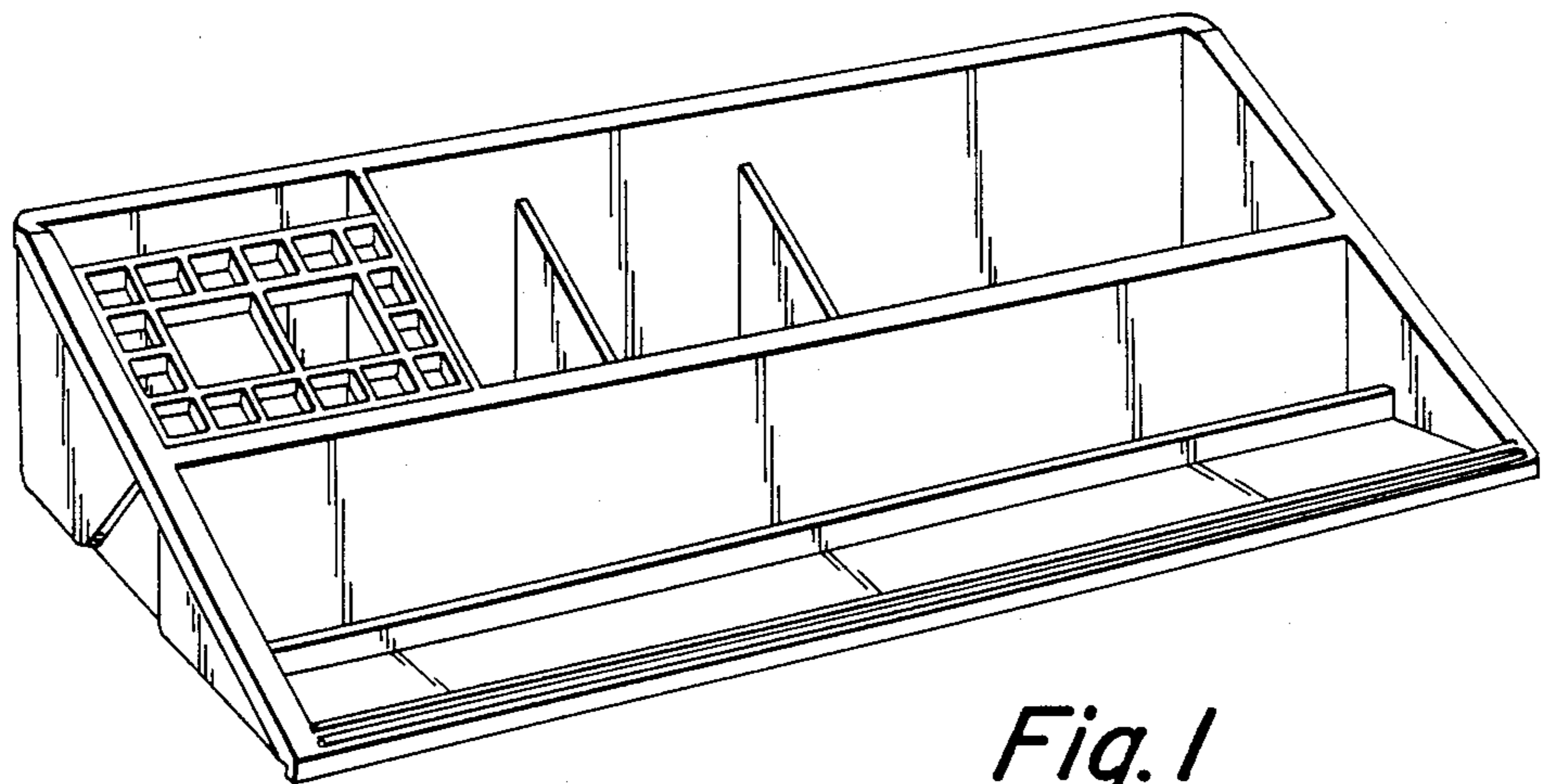

Fig. 1

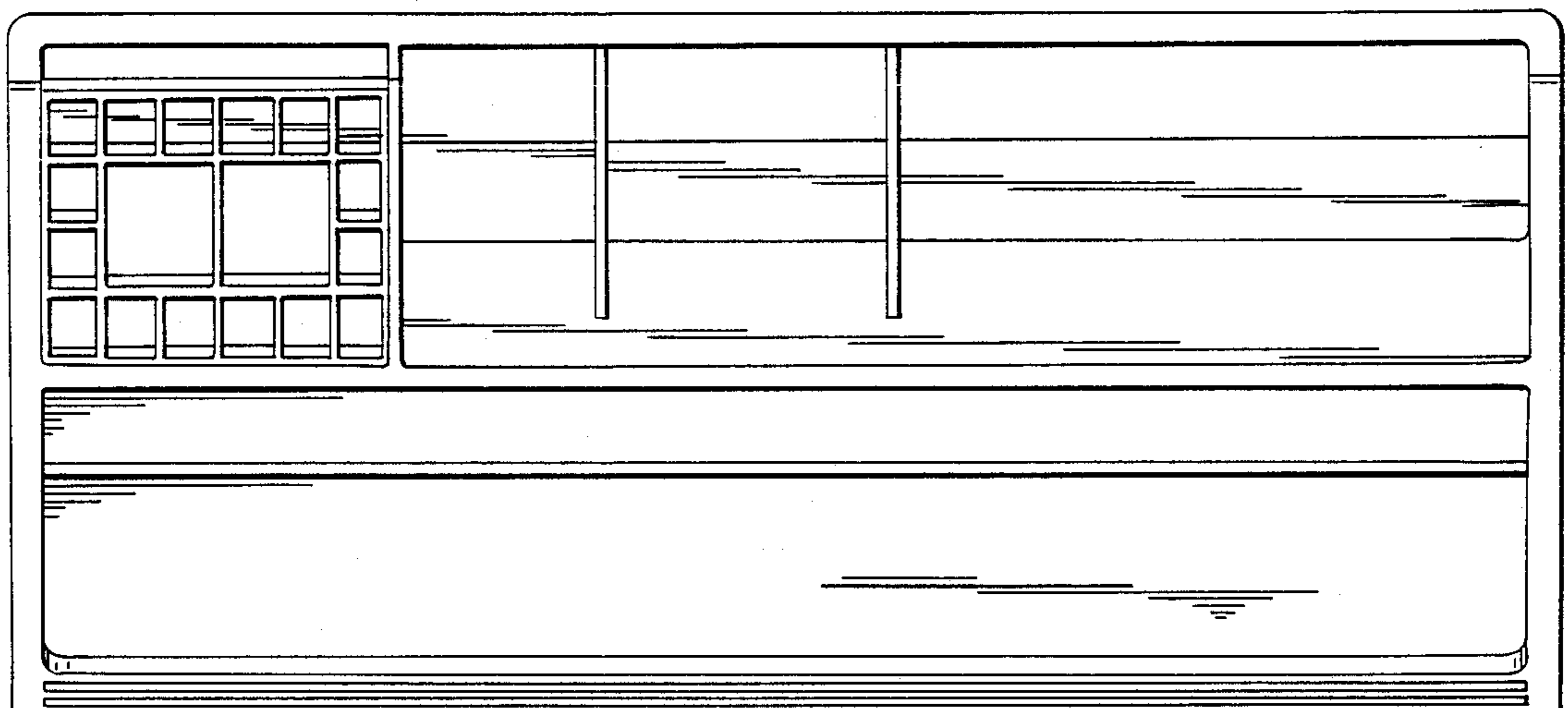

Fig. 2

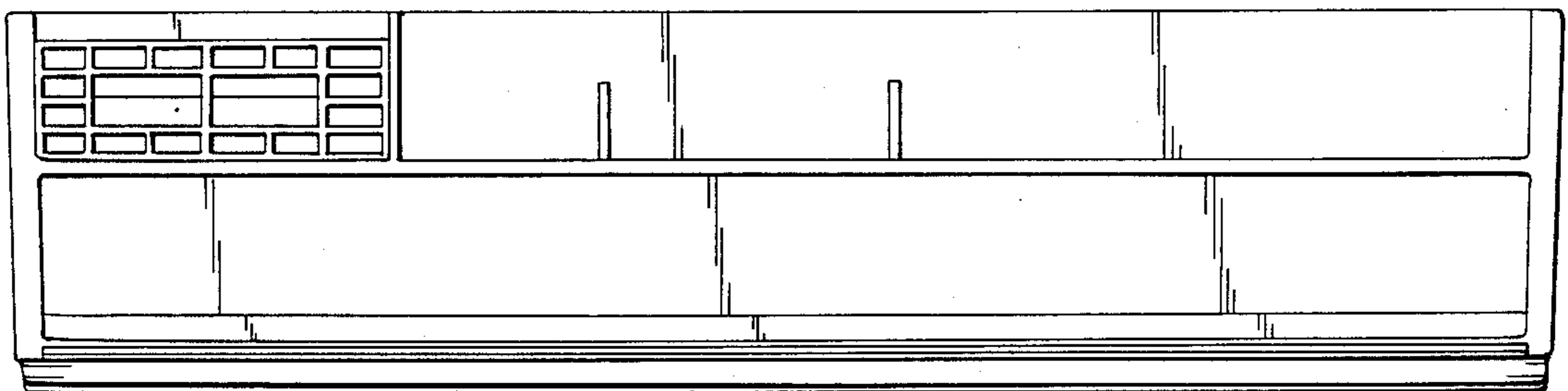

Fig. 3

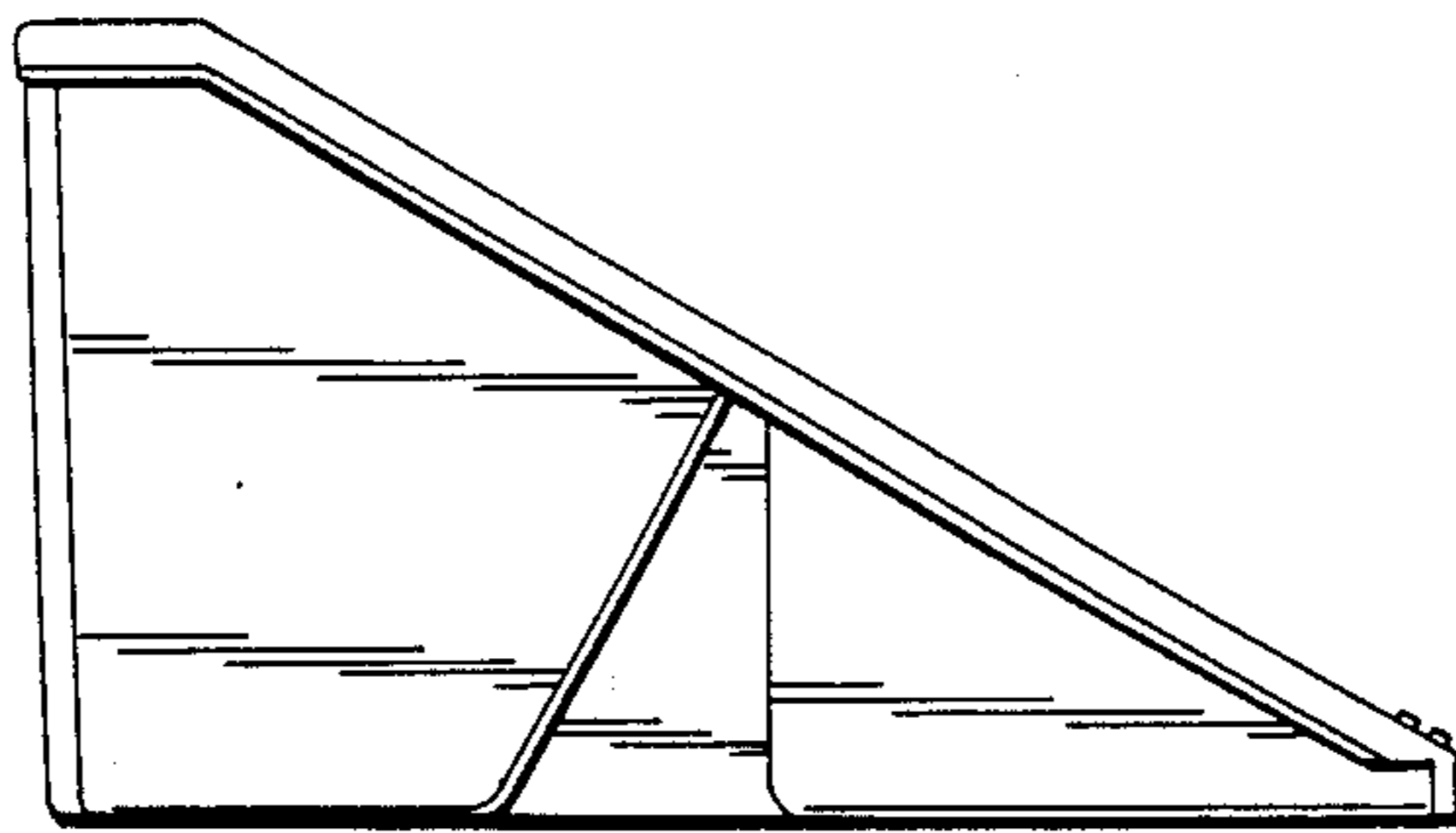

Fig. 4

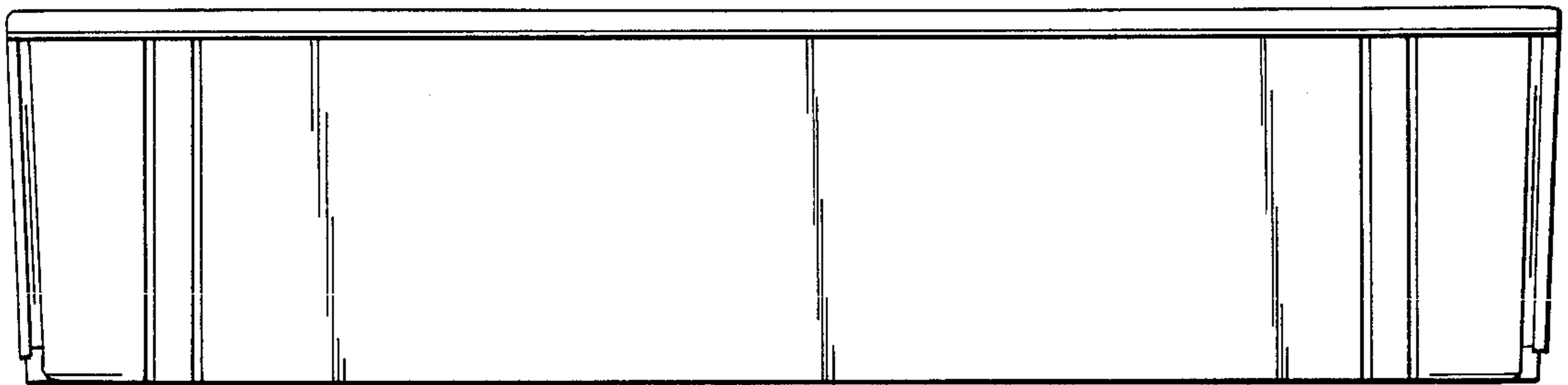

Fig. 5

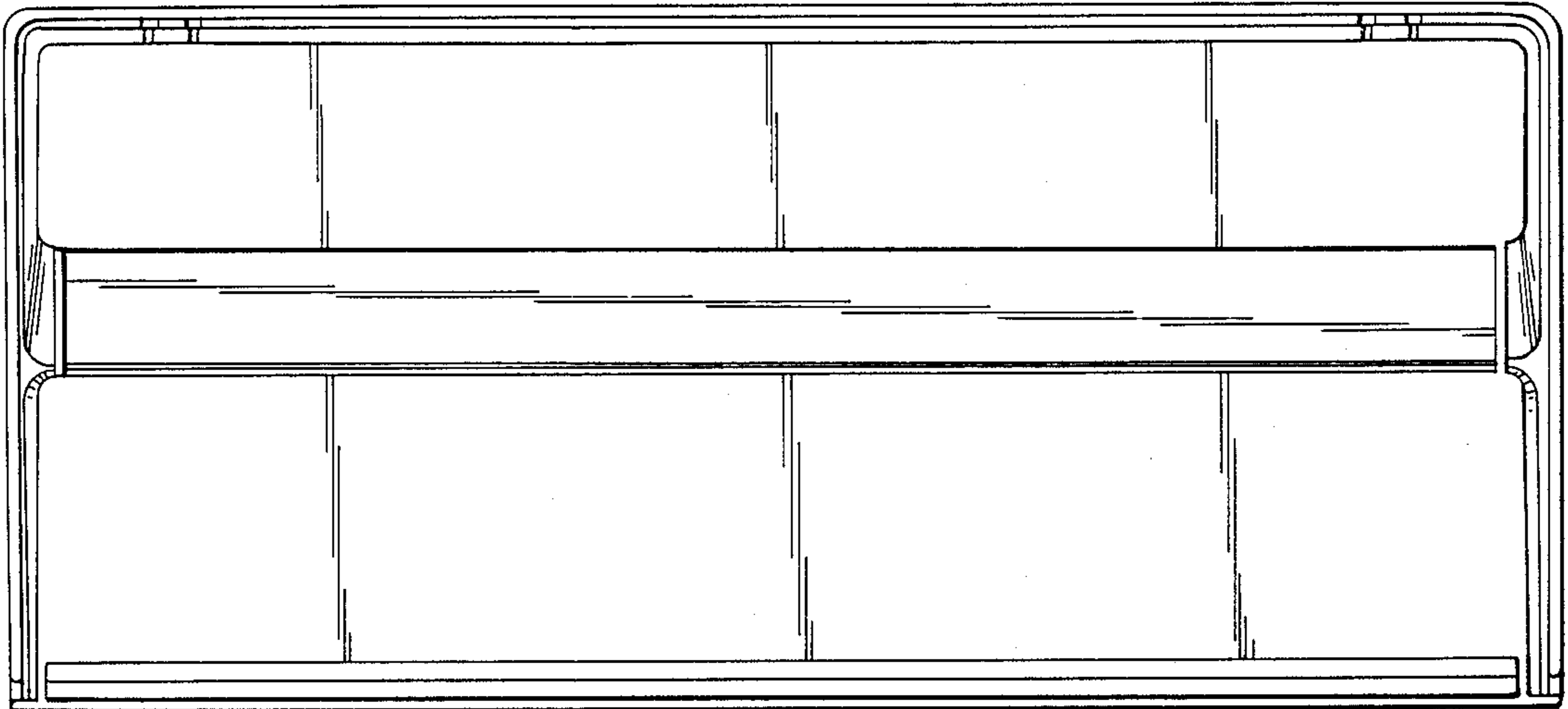

Fig. 6