

United States Patent [19]

Nishiyama et al.

[11] Patent Number: **Des. 303,796**

[45] Date of Patent: **** Oct. 3, 1989**

[54] **CASSETTE FOR A VIDEO TAPE RECORDER**

4,733,317 3/1988 Sato et al. 242/199 X

[75] Inventors: **Kenji Nishiyama, Nara; Hanji Takahashi, Hyogo; Yoshitomo Itakura, Osaka, all of Japan**

FOREIGN PATENT DOCUMENTS

437404 12/1976 Japan .
483901 9/1978 Japan .
56-8512 1/1982 Japan .
619993 8/1984 Japan .

[73] Assignee: **Matsushita Electric Industrial Co., Ltd., Osaka, Japan**

Primary Examiner—Bernard Ansher
Assistant Examiner—Theodore M. Shooman
Attorney, Agent, or Firm—Sughrue, Mion, Zinn, Macpeak & Seas

[**] Term: **14 Years**

[21] Appl. No.: **904,313**

[22] Filed: **Sep. 5, 1986**

[57] CLAIM

The ornamental design for a cassette for a video tape recorder, as shown and described.

[30] Foreign Application Priority Data

Mar. 5, 1986 [JP] Japan 61-7804

[52] U.S. Cl. **D14/121**

[58] Field of Search D14/115, 120, 121, 122;
242/71.8, 197, 198, 199

DESCRIPTION

FIG. 1 is a top, front and right side perspective view of a cassette for a video tape recorder showing our new design;

FIG. 2 is a top plan view thereof;

FIG. 3 is a bottom plan view thereof;

FIG. 4 is a front elevational view thereof;

FIG. 5 is a rear elevational view thereof;

FIG. 6 is a left side elevational view thereof;

FIG. 7 is a right side elevational view thereof; and

FIG. 8 is a top, front and right side perspective view thereof, shown with the front cover in an open position.

[56] References Cited

U.S. PATENT DOCUMENTS

D. 263,701 4/1982 Morita D14/121
D. 268,671 4/1983 Ohya et al. D14/121
D. 271,392 11/1983 Sumisha et al. D14/121
4,419,708 12/1983 Ogiro et al. 242/197 X
4,642,721 2/1987 Georgens et al. 242/198 X
4,678,138 7/1987 Nemoto 242/198

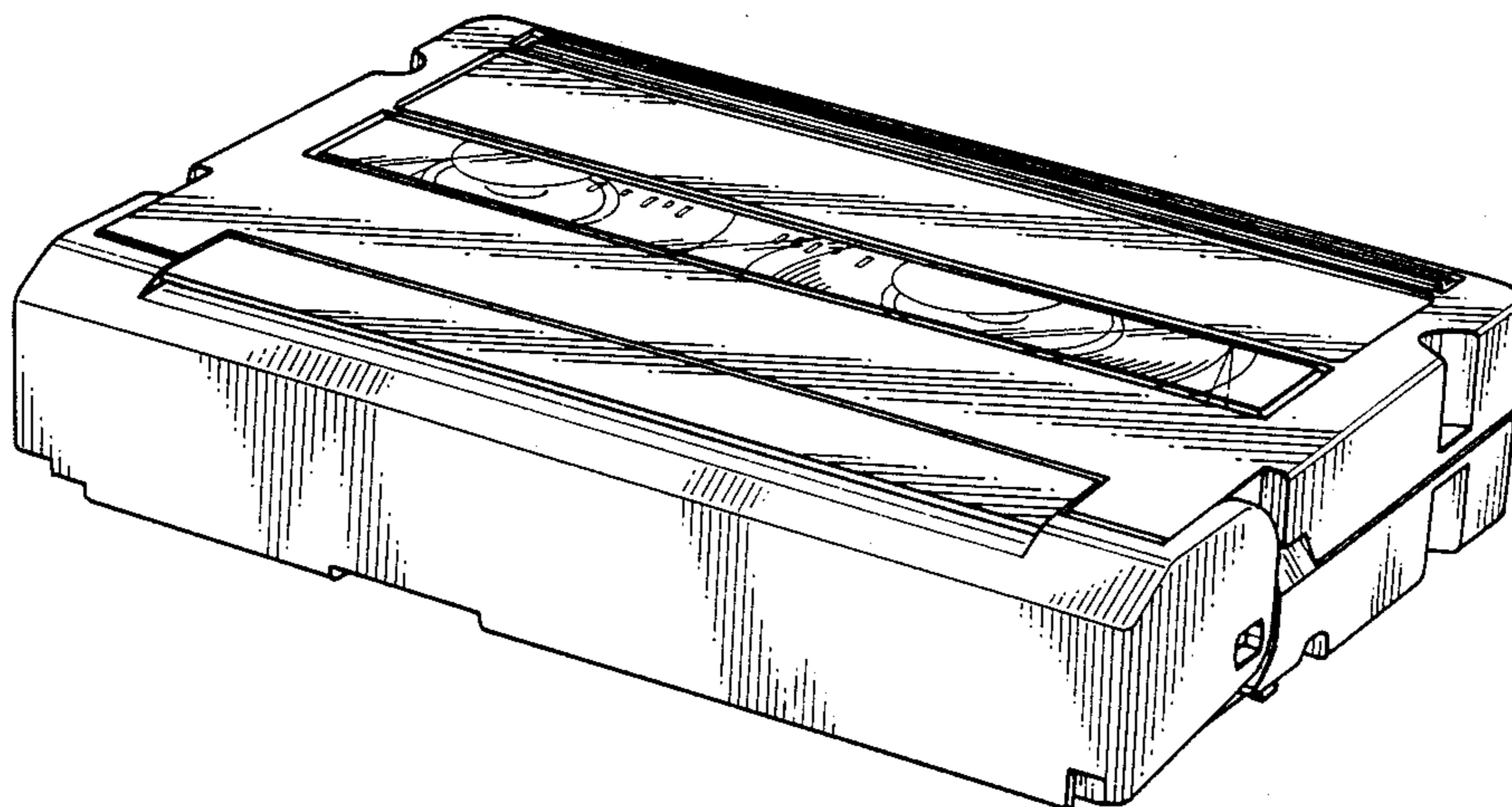

Fig. 1

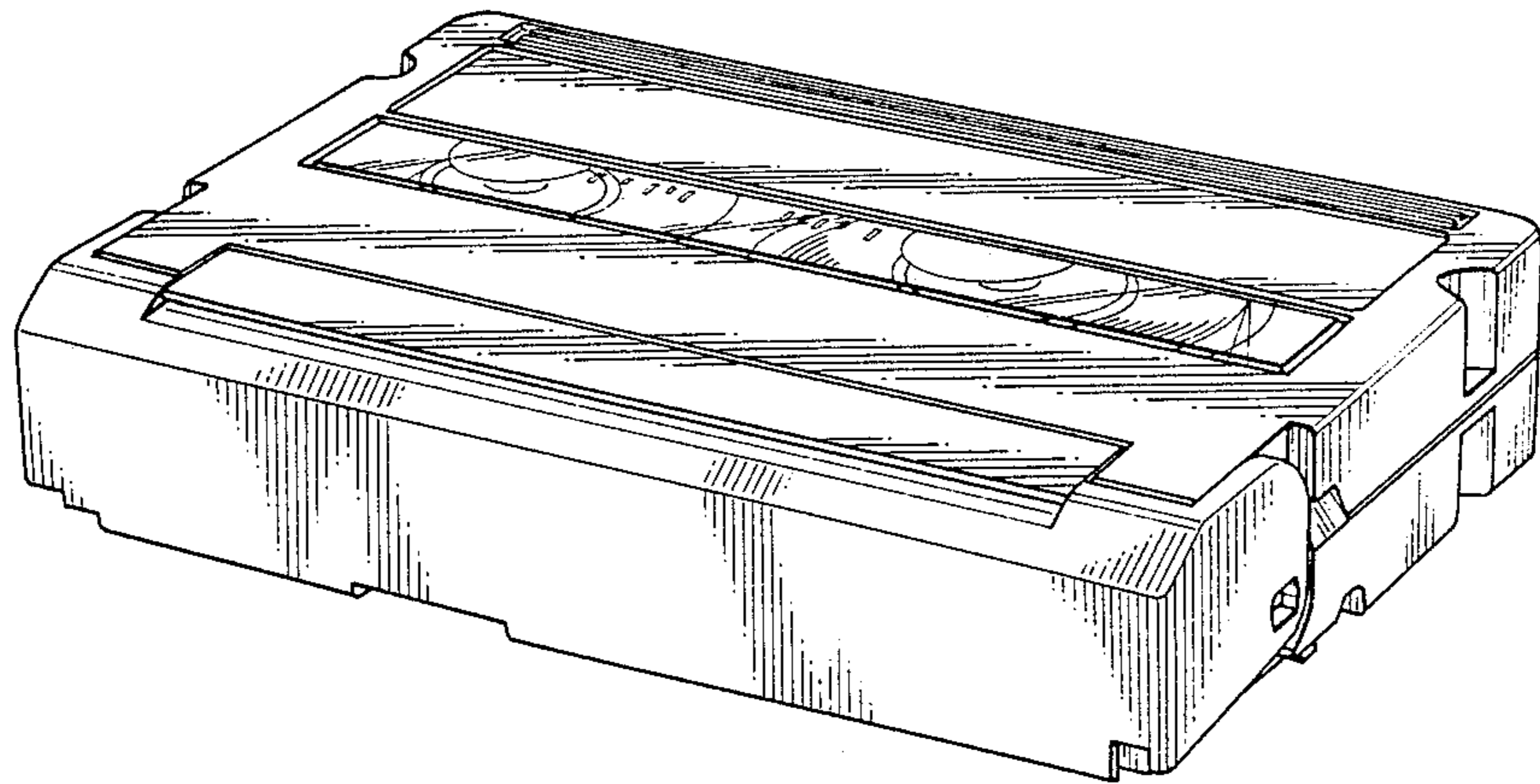

Fig. 2

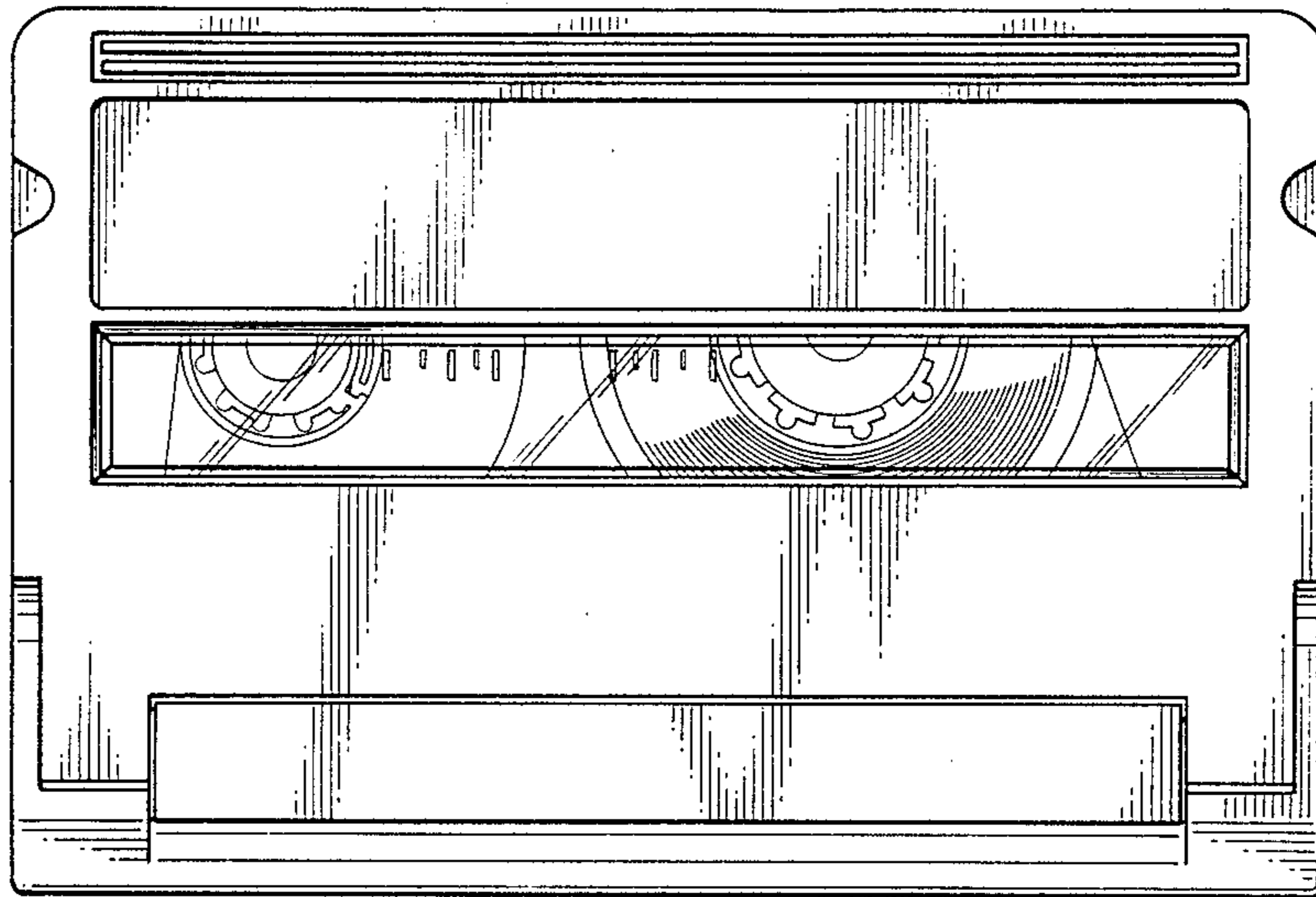

Fig. 3

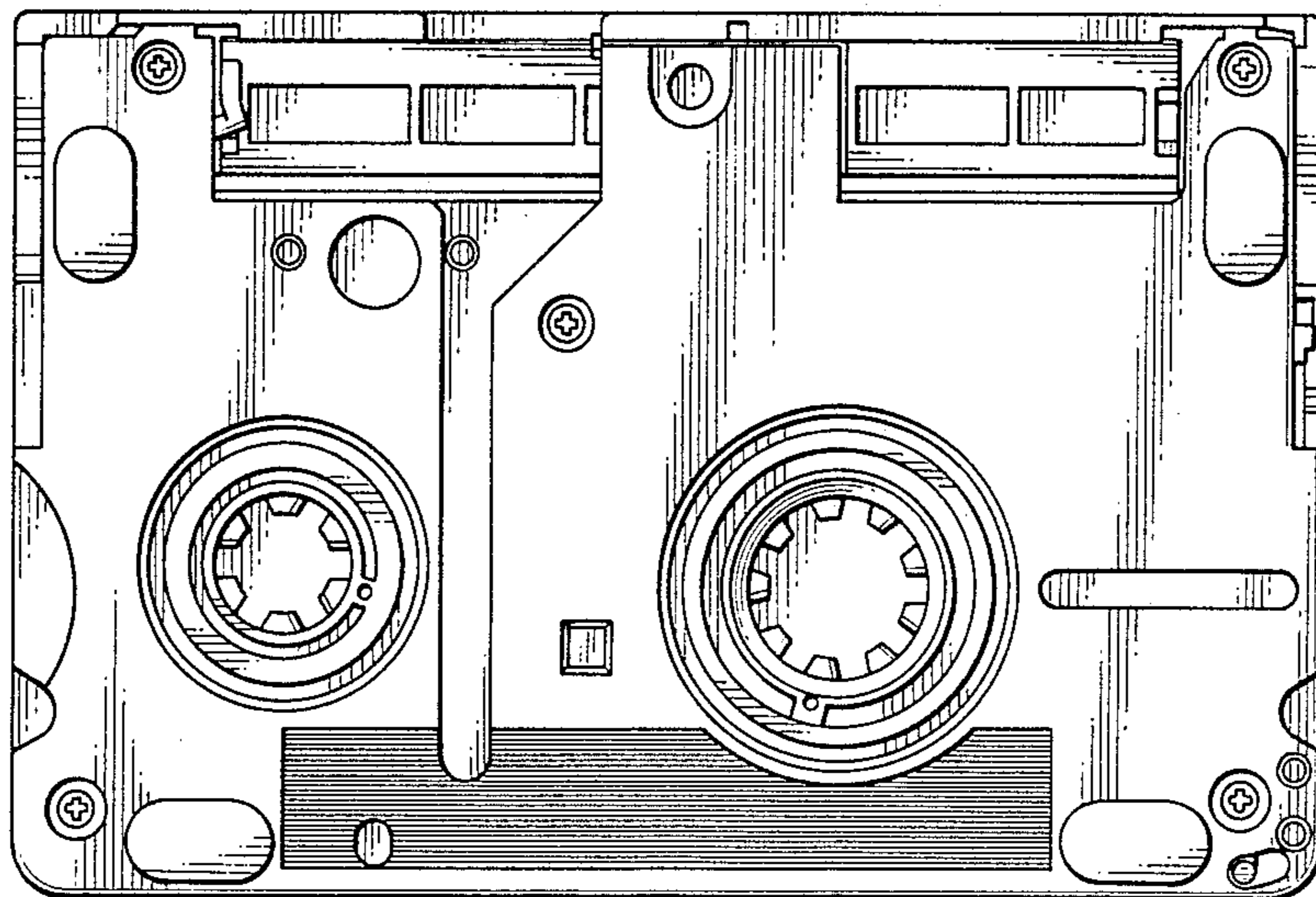

Fig. 4

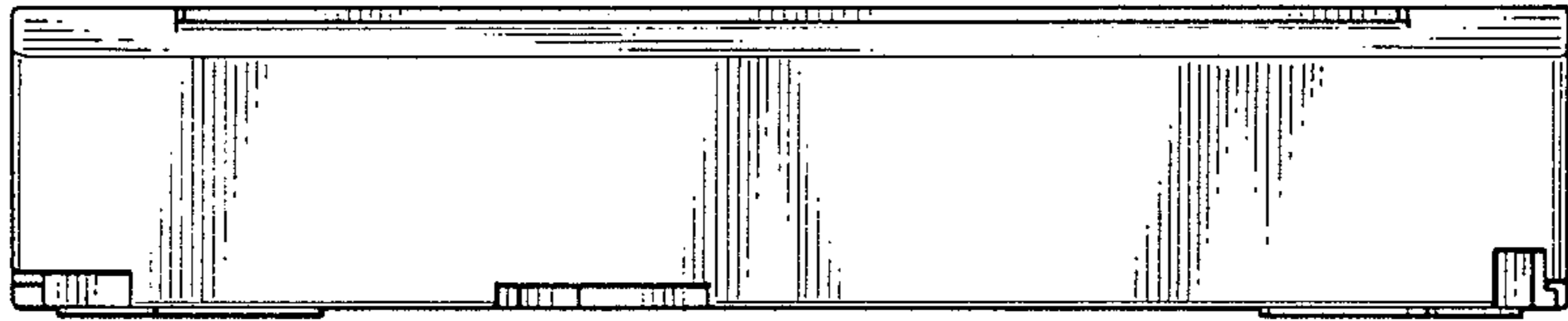

Fig. 5

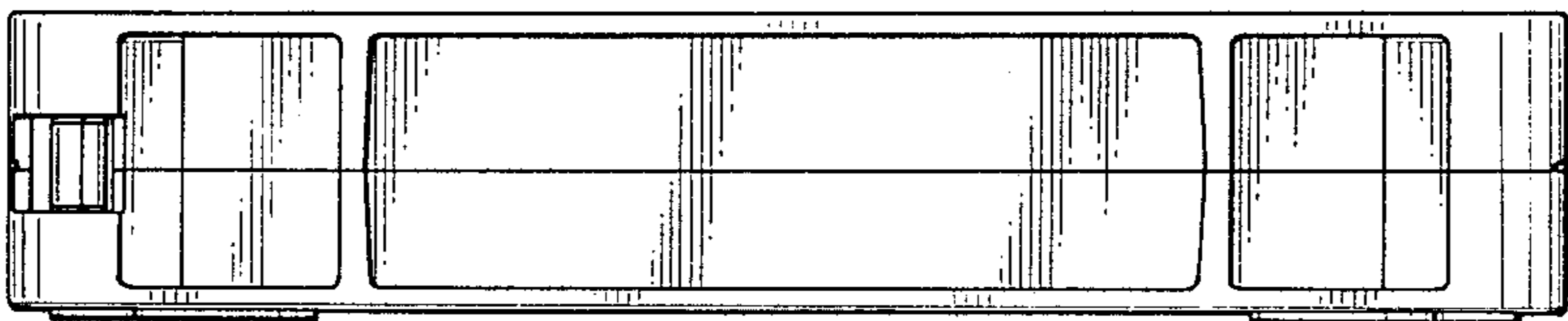

Fig. 6

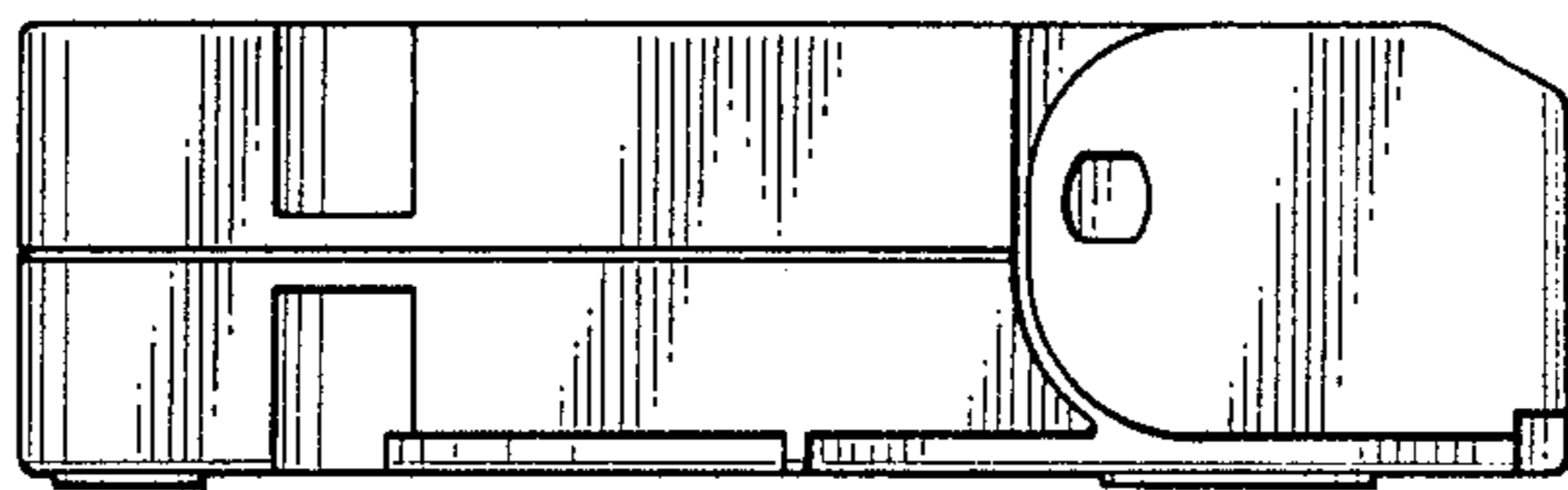

Fig. 7

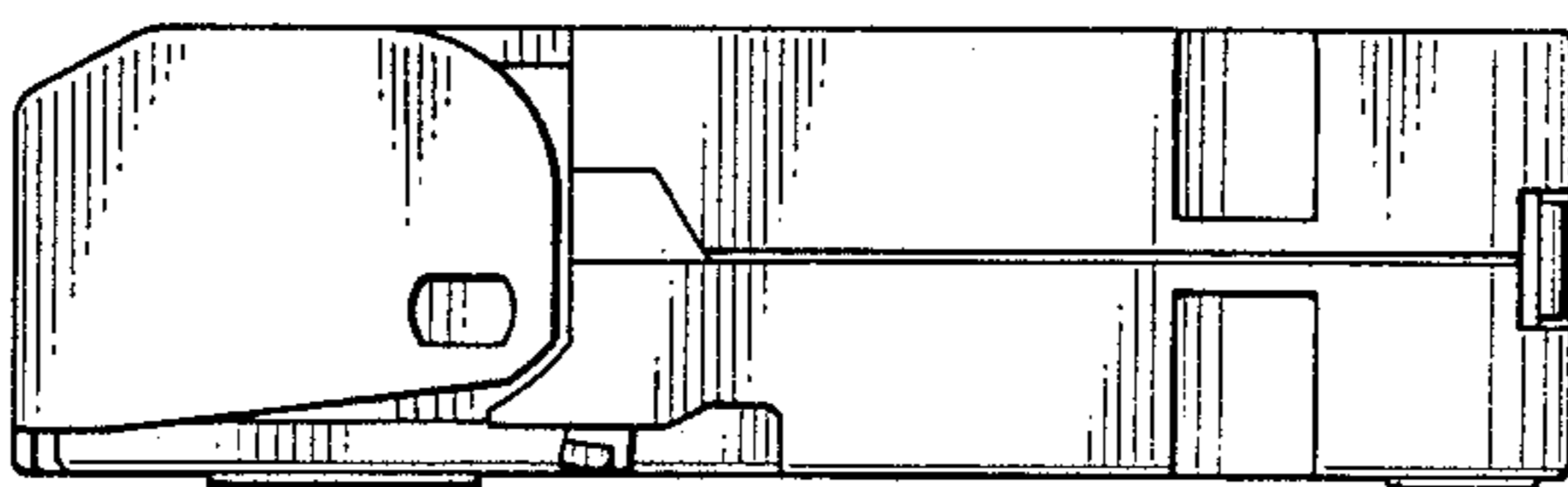

Fig. 8

