

[54] VIDEO ALARM CASSETTE

[75] Inventor: Peter D. Brown, Otley, Great Britain

[73] Assignee: Embassy Safety & Security Limited, Huddersfield, England

[**] Term: 14 Years

[21] Appl. No.: 63,634

[22] Filed: Jun. 18, 1987

[52] U.S. Cl. D14/121

[58] Field of Search D14/115, 120, 121, 122; 242/71.8, 197, 198, 199

[56] References Cited

U.S. PATENT DOCUMENTS

D. 245,726	9/1977	Sottsass	D14/121	X
D. 245,908	9/1977	Kishi	D14/121	
D. 278,145	3/1985	Matsumoto	D14/121	
3,900,172	8/1975	Kamaya	D14/121	X
4,163,533	8/1979	Abe	242/198	

4,419,708	12/1983	Ogiro et al.	242/197	X
4,589,609	5/1986	Oishi et al.	242/198	
4,672,497	6/1987	Ueda	D14/121	X

Primary Examiner—Bernard Ansher
Assistant Examiner—Theodore M. Shooman
Attorney, Agent, or Firm—Oldham & Oldham Co.

[57] CLAIM

The ornamental design for a video alarm cassette, as shown and described.

DESCRIPTION

FIG. 1 is a left side elevational view of a video alarm cassette showing my new design; FIG. 2 is a top plan view thereof; FIG. 3 is a front elevational view thereof, the rear being a mirror image; FIG. 4 is a bottom plan view thereof; FIG. 5 is a right side elevational view thereof; and FIG. 6 is a bottom, front and right side perspective view thereof.

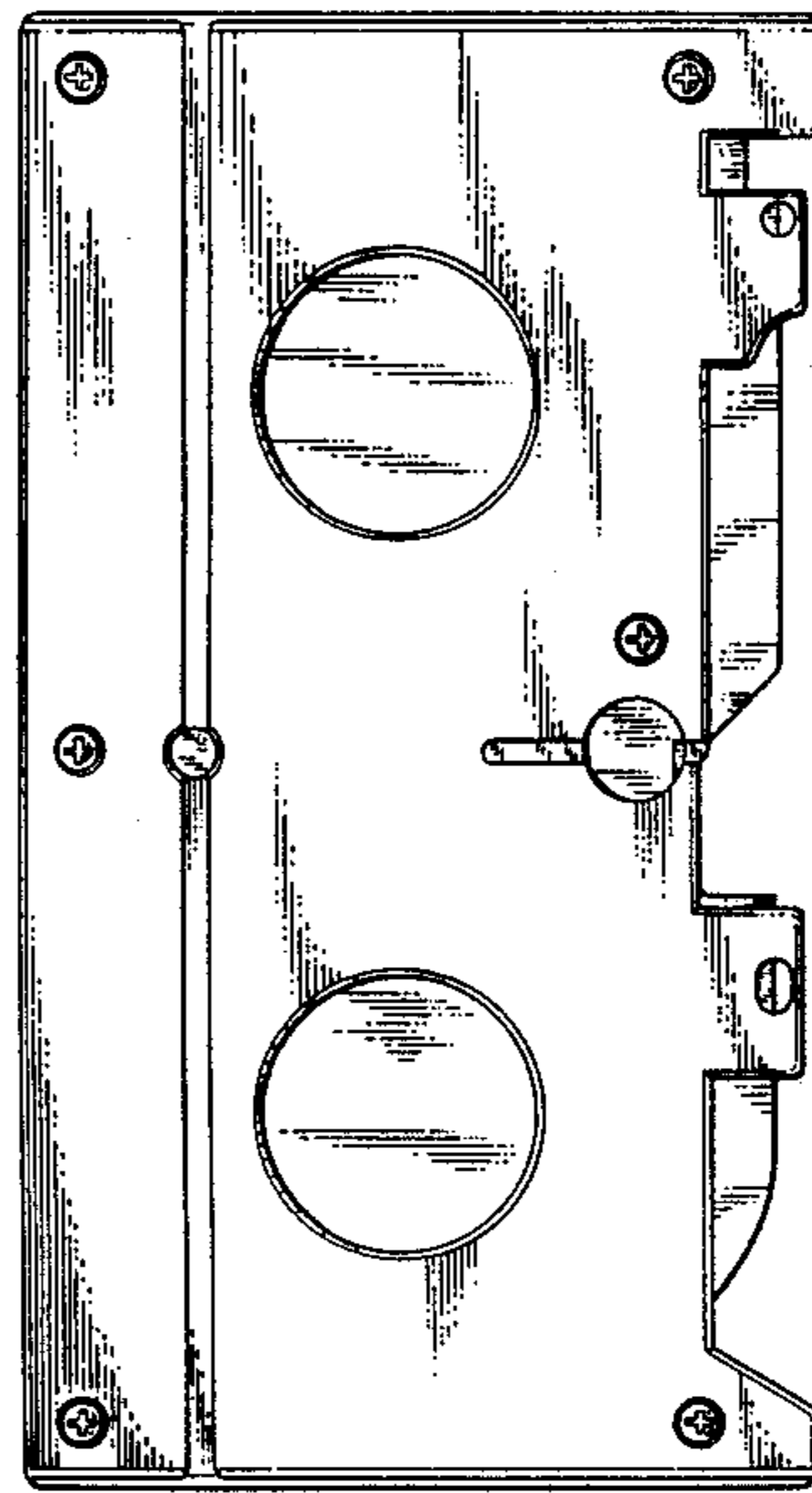
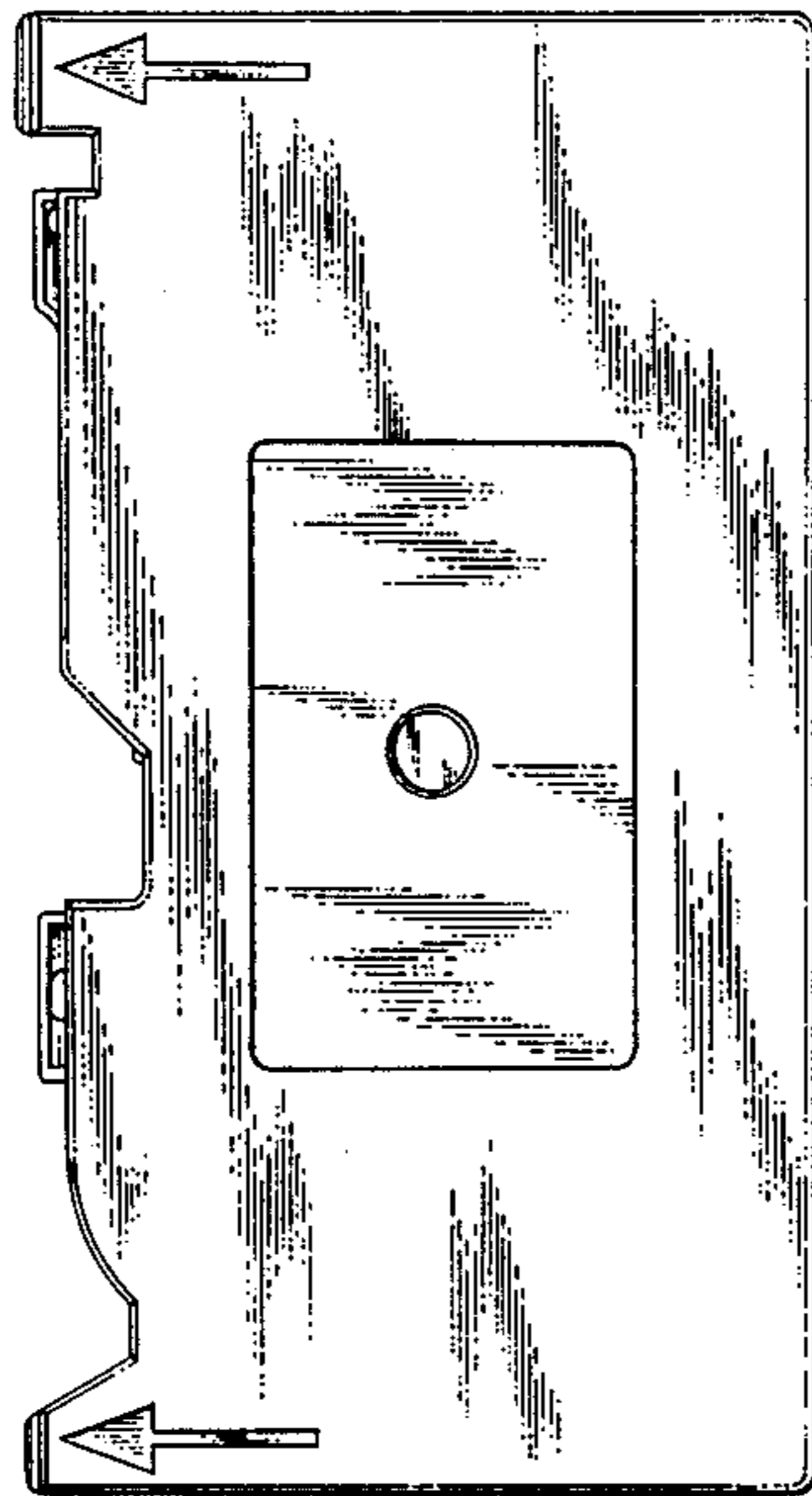

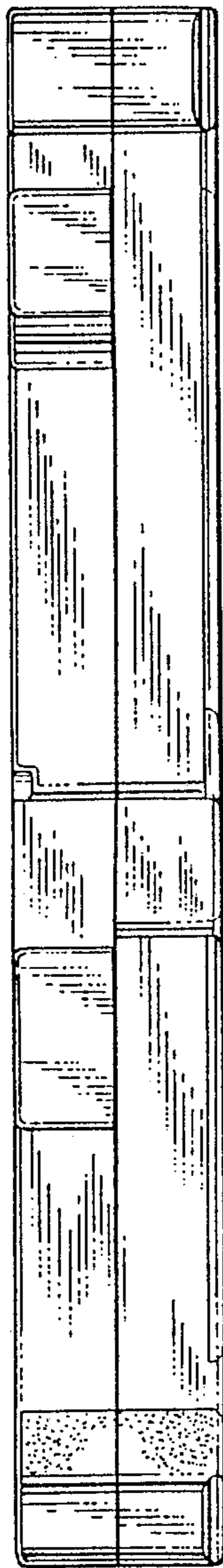

FIG. 1.

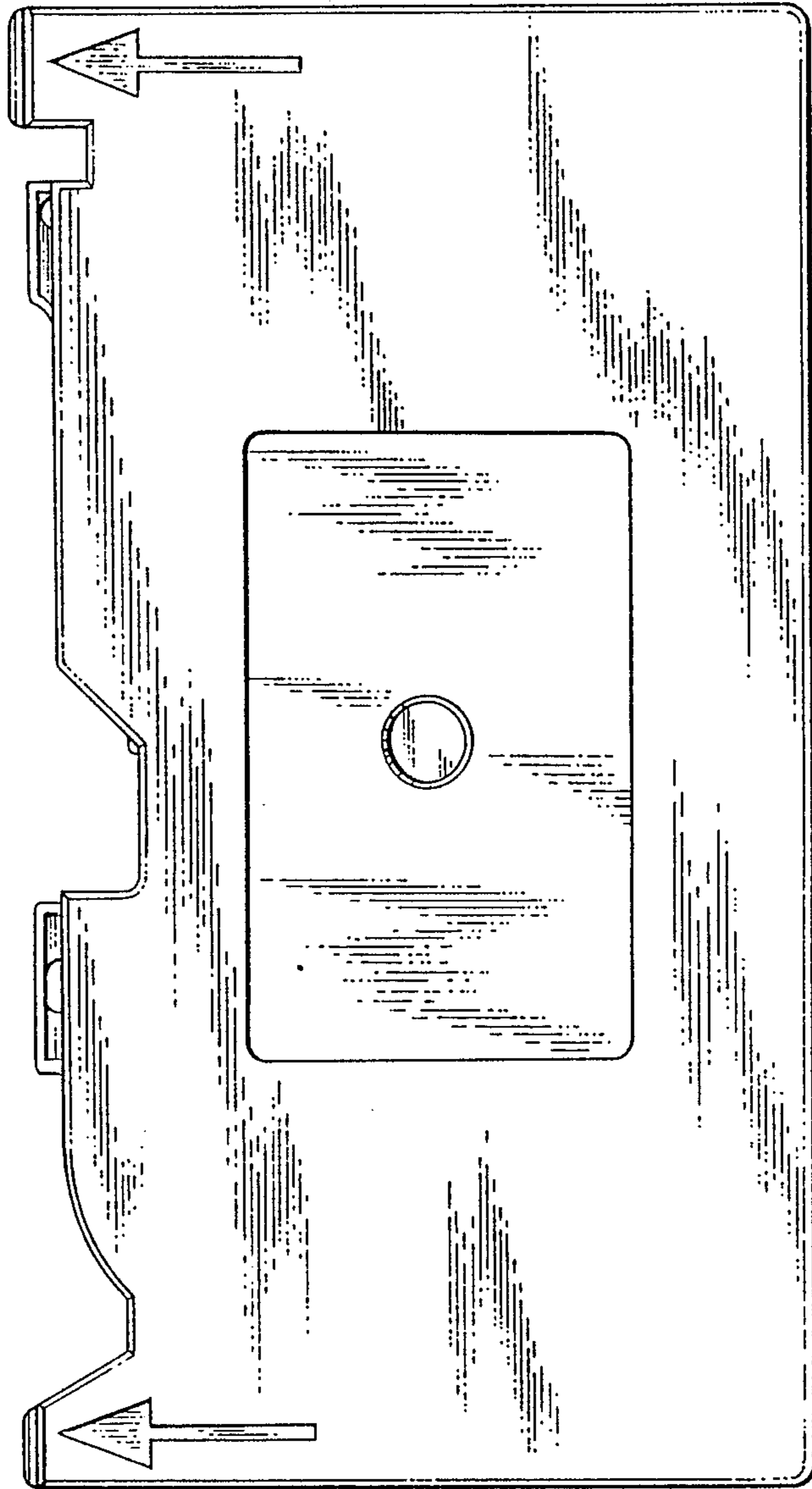

FIG. 2.

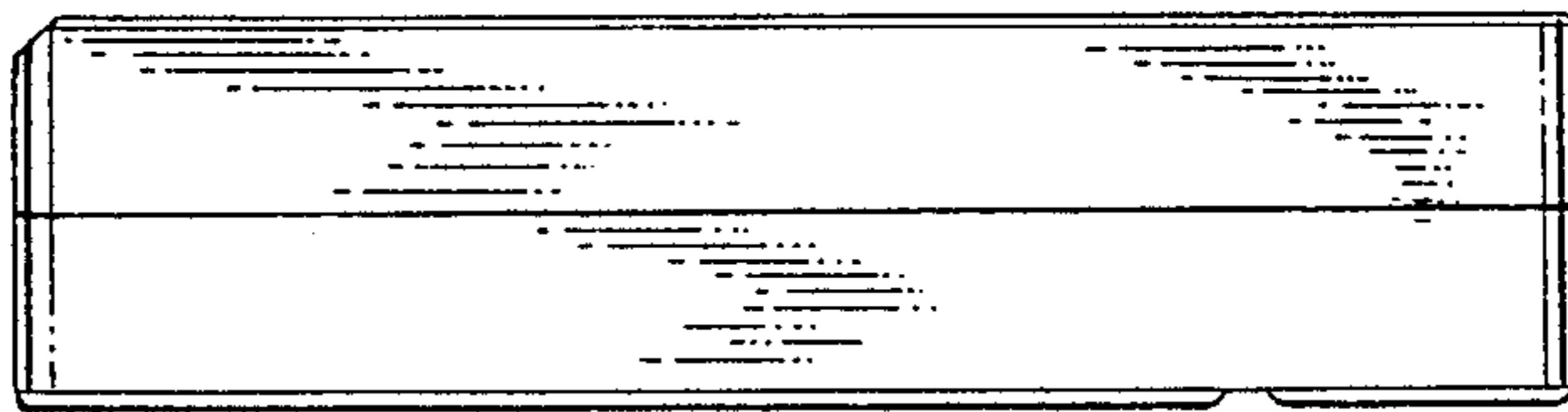

FIG 3

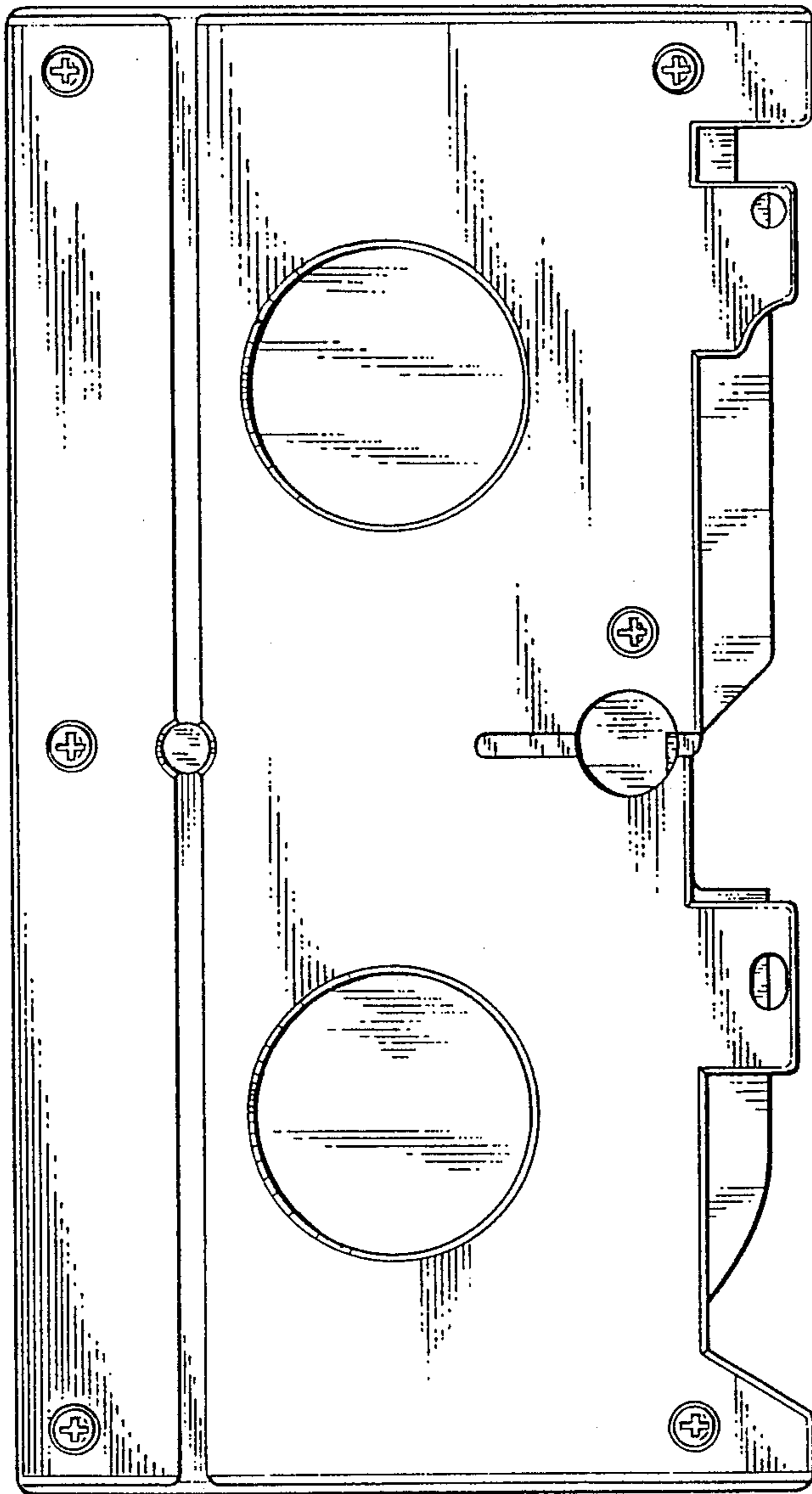

FIG. 4.

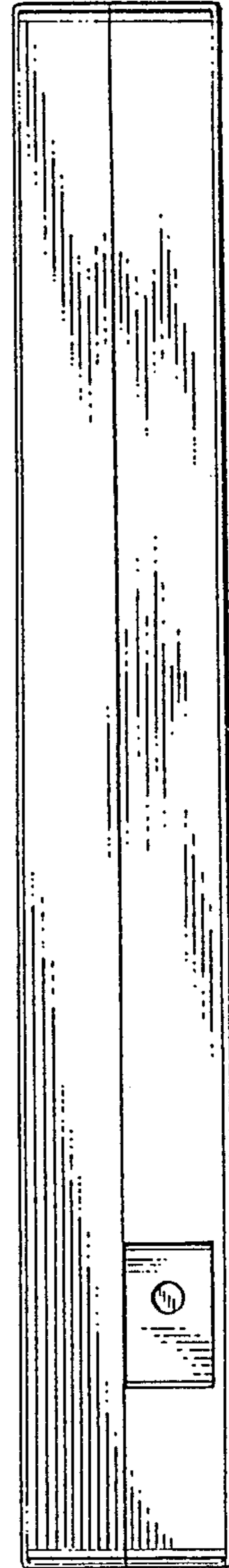

FIG. 5.

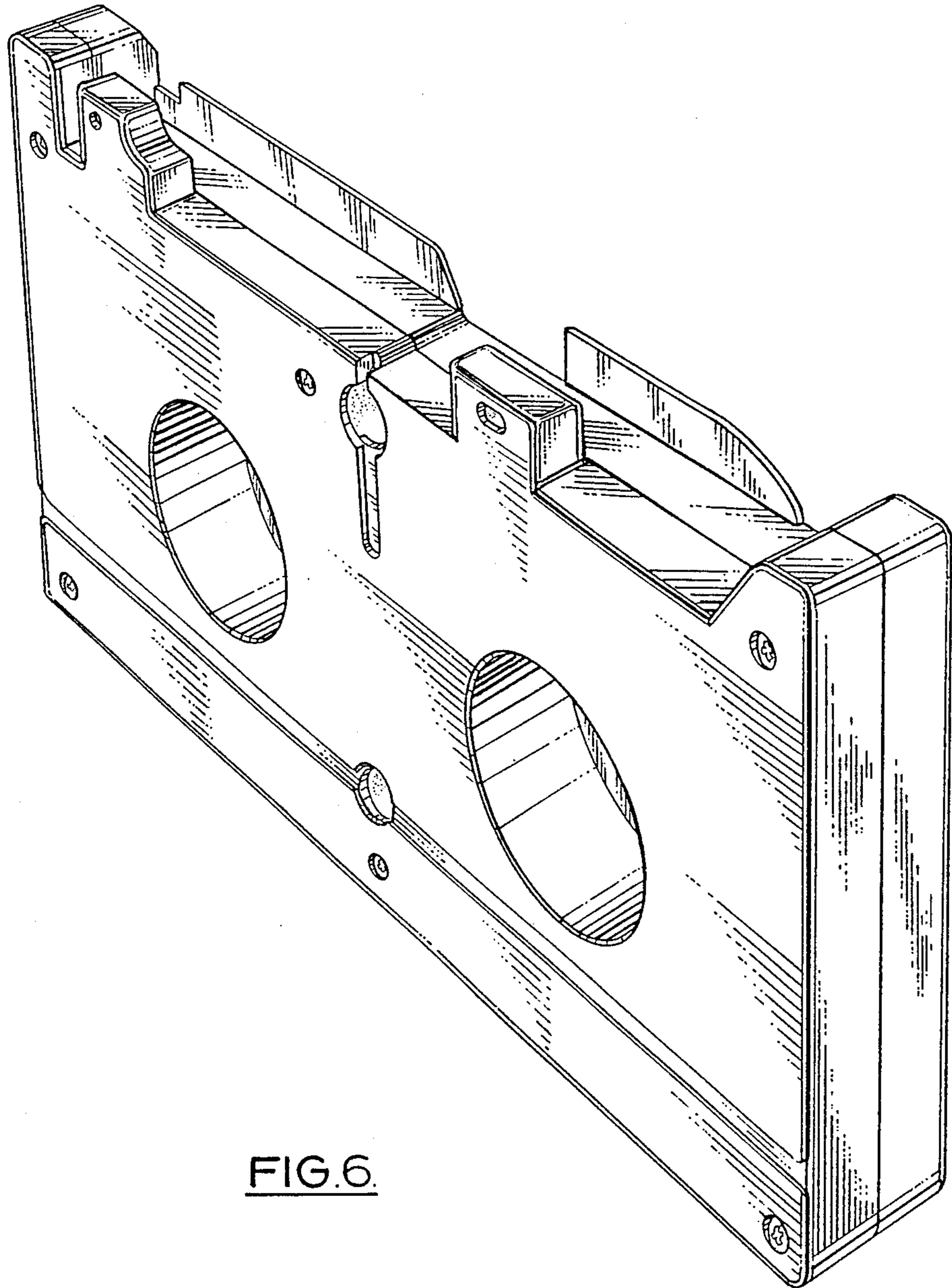

FIG. 6.