

[54] **LUGGAGE CARRIER OR SIMILAR ARTICLE FOR TWO-WHEELED VEHICLES**

[76] **Inventor: Oskar Pletscher, 8460 Marthalen, Switzerland**

[**] **Term: 14 Years**

[21] **Appl. No.: 50,135**

[22] **Filed: May 14, 1987**

[30] **Foreign Application Priority Data**

Dec. 12, 1986 [CH] Switzerland DM/007 909
 [52] **U.S. Cl. D12/158**
 [58] **Field of Search D12/158; 224/32 R, 32 A, 224/35, 39**

[56] **References Cited**

U.S. PATENT DOCUMENTS

D. 271,759	12/1983	Patterson et al.	D12/158
D. 276,991	1/1985	Blackburn	D12/158
D. 285,426	9/1986	Blackburn et al.	D12/158
1,547,671	7/1925	Mathews	D12/158
4,383,625	5/1983	Kiang	224/30 R
4,477,004	10/1984	Barro	224/39
4,760,943	8/1988	Bass et al.	224/30 R

FOREIGN PATENT DOCUMENTS

914245 6/1946 France 224/30 R

OTHER PUBLICATIONS

American Bicyclist & Motorcyclist, 8/85, p. 48, MTB Superack AC-600 Bicycle Carry Rack.
 Blackburn Brochure, 2/80, Blackburn Bicycle Carry Rack, inside brochure.
 Showa flyer, 2/80, Super Lightweight Rear Bicycle Carrier.

Primary Examiner—James M. Gandy
Assistant Examiner—Melody Brown
Attorney, Agent, or Firm—Werner W. Kleeman

[57] **CLAIM**

The ornamental design for a luggage carrier or similar article for two-wheeled vehicles, as shown.

DESCRIPTION

FIG. 1 is a rear perspective view of my luggage carrier or similar article for two-wheeled vehicles incorporating my invention;
 FIG. 2 is a top plan view thereof;
 FIG. 3 is a side elevation view thereof;
 FIG. 4 is an opposite side elevation view thereof;
 FIG. 5 is a bottom plan view thereof;
 FIG. 6 is a rear elevation view thereof; and
 FIG. 7 is a front elevation view thereof.

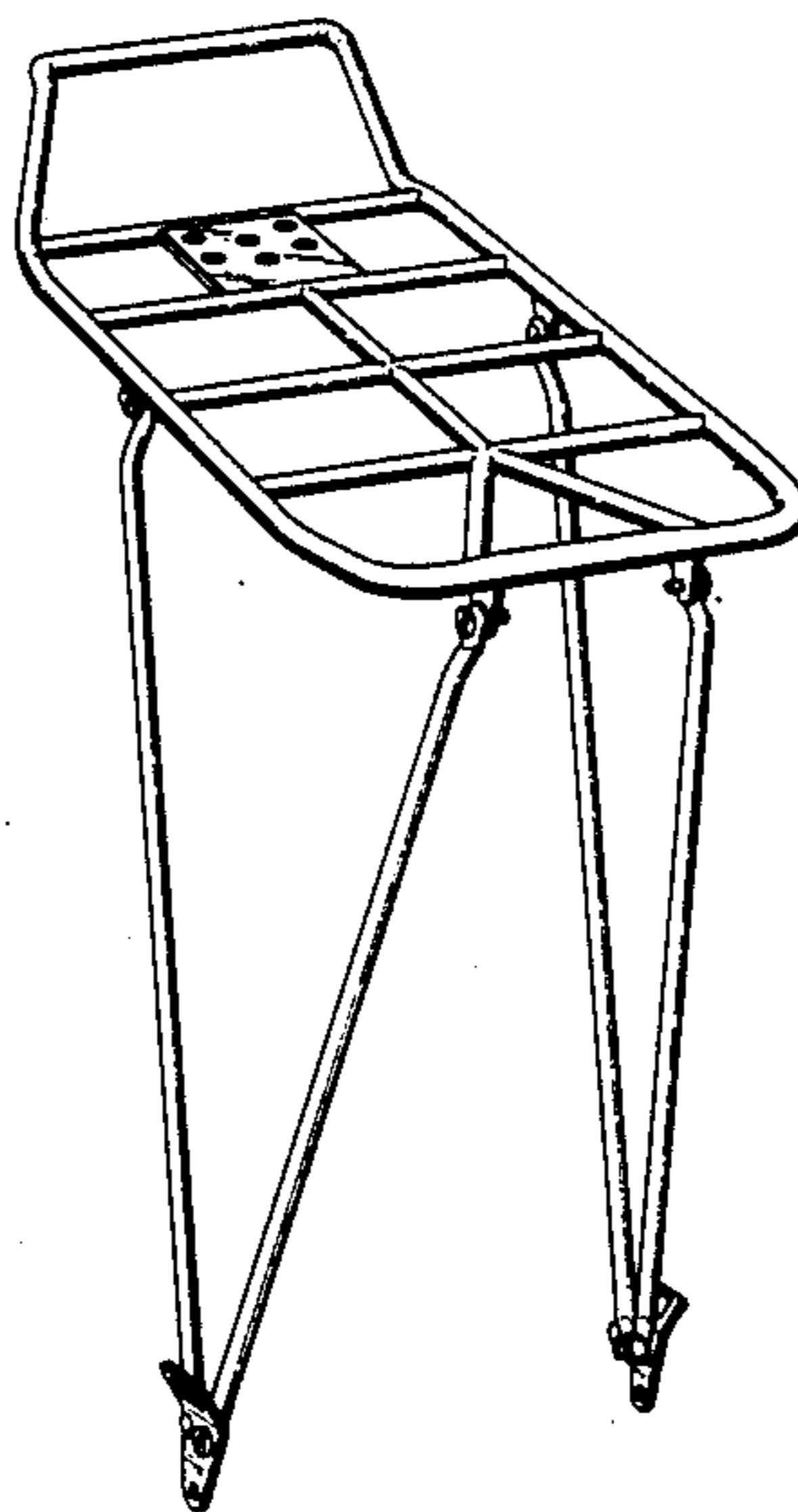

Fig. 1

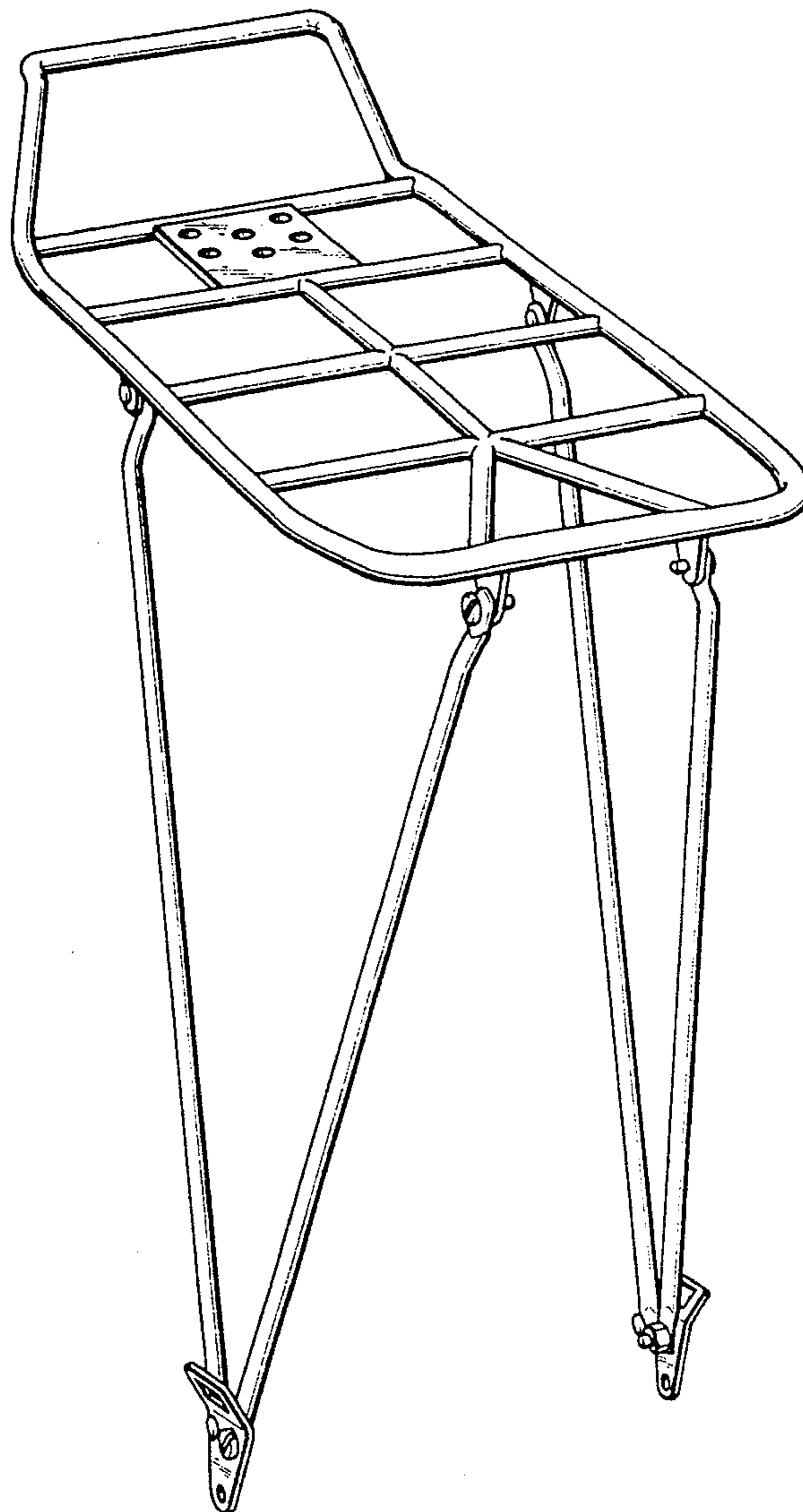

Fig. 2

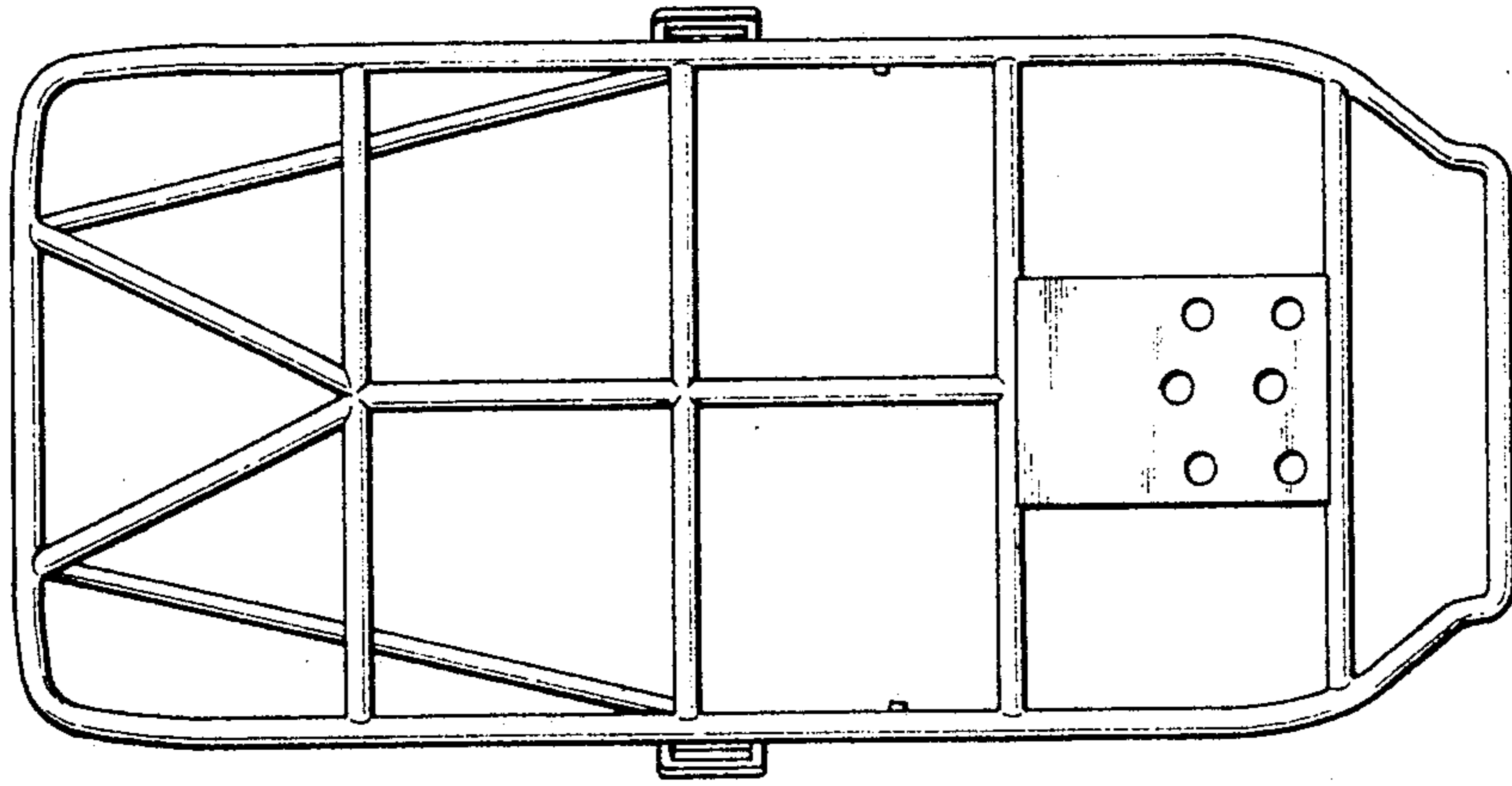
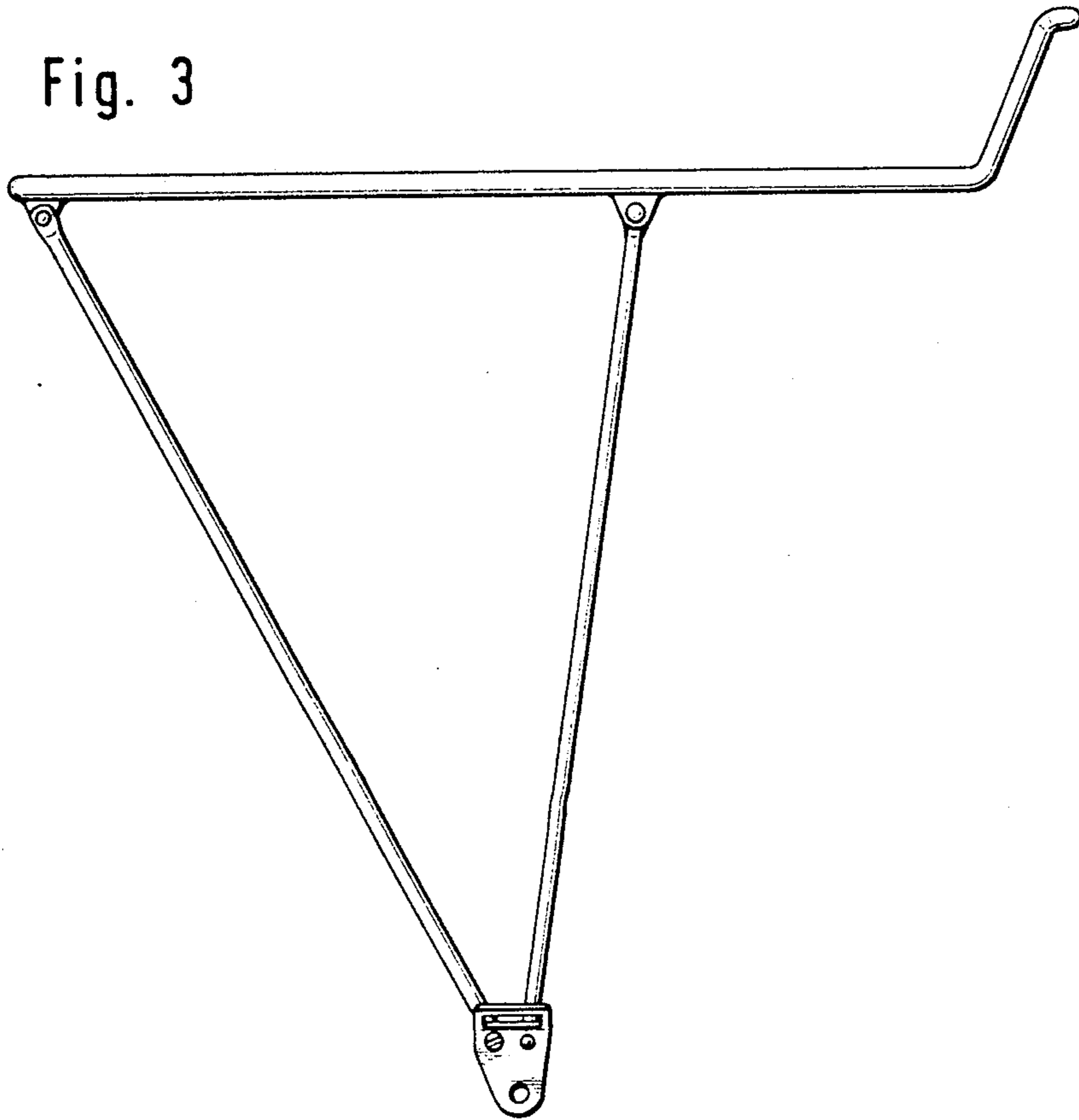

Fig. 3



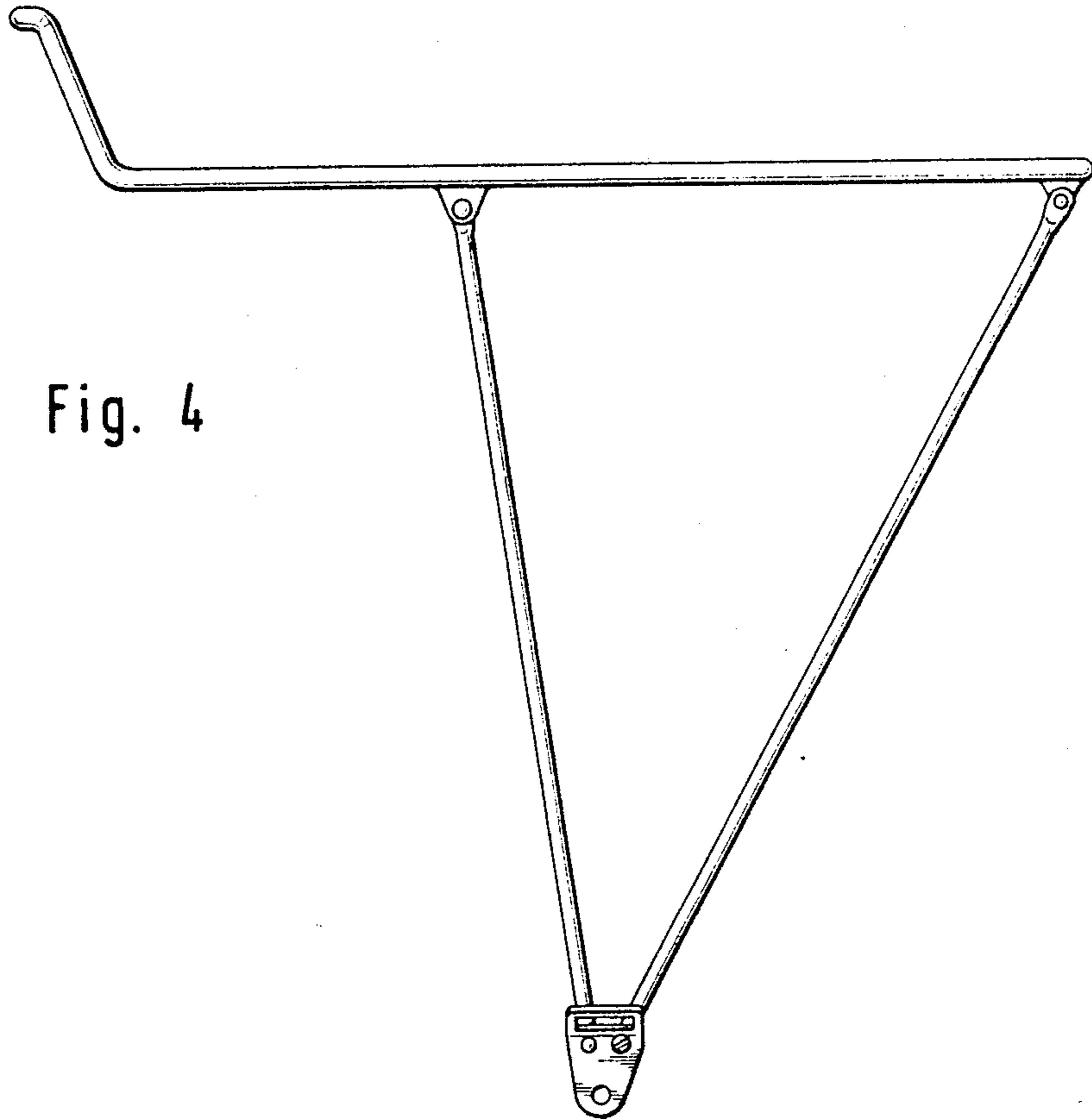

Fig. 4

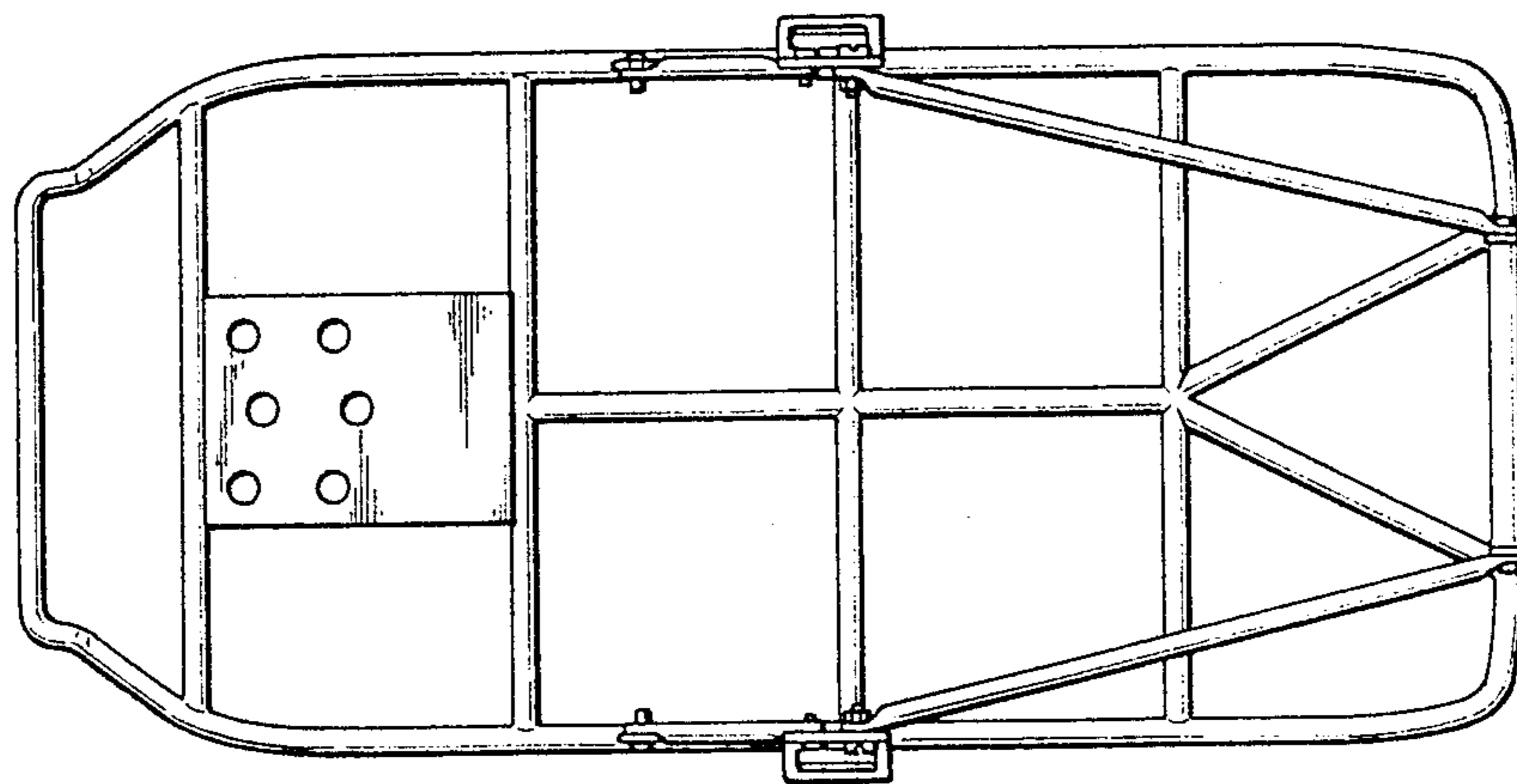

Fig. 5

Fig. 6

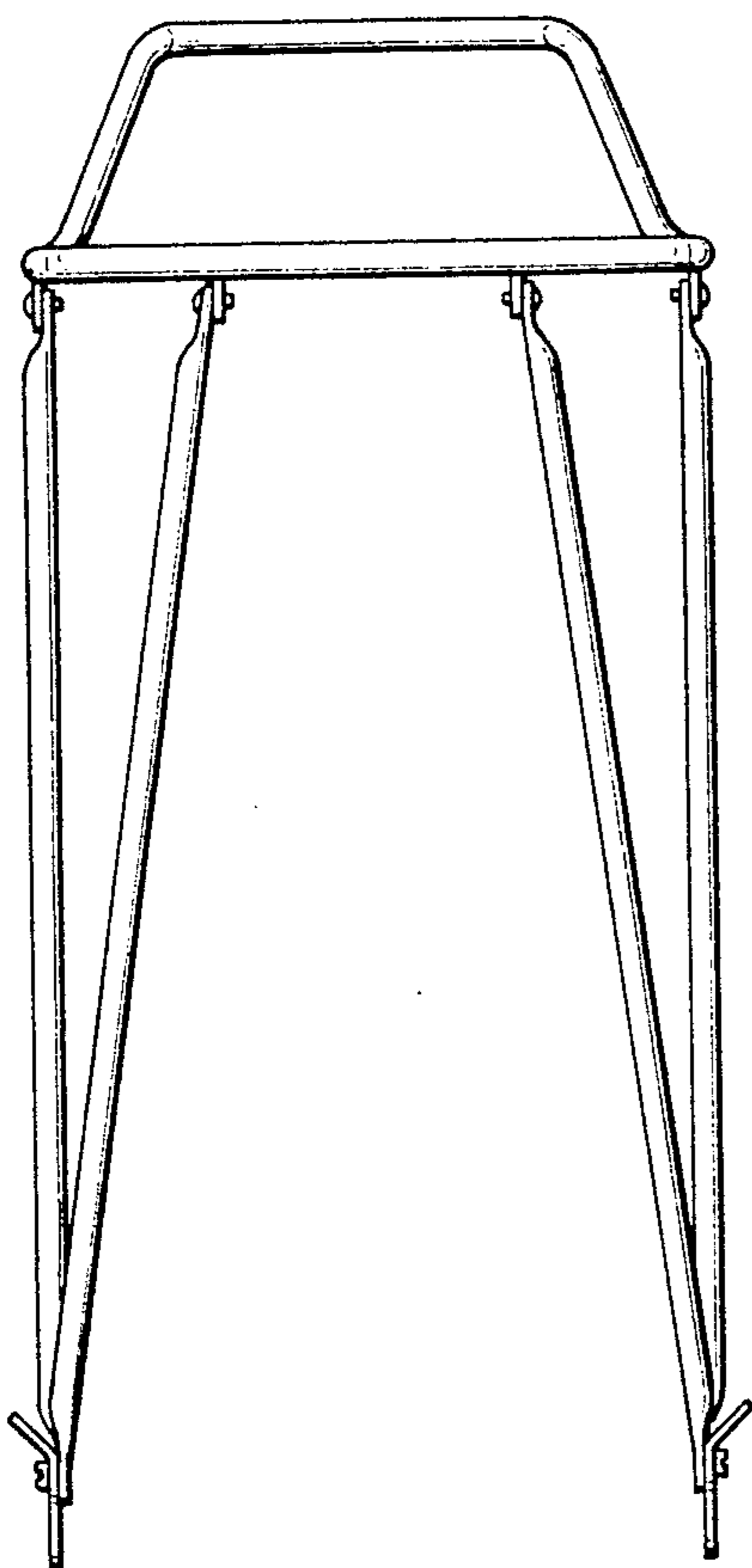

Fig. 7

