

[54] WRIST WATCH

4,668,100 5/1987 Murakami 368/10

[75] Inventor: Masamichi Wakamatsu, Akishima, Japan

OTHER PUBLICATIONS

[73] Assignee: Casio Computer Co., Ltd., Tokyo, Japan

Jeweler's Circular-Keystone-3/82-p. 93-Game Watch at right.
Hong Kong Enterprise-1/82-p. 250-Watch at center-right.

[**] Term: 14 Years

Primary Examiner—Nelson C. Holtje
Attorney, Agent, or Firm—Frishauf, Holtz, Goodman & Woodward

[21] Appl. No.: 911,626

[22] Filed: Sep. 25, 1986

[52] U.S. Cl. D10/38; D10/30

[58] Field of Search D10/30-39,
D10/122-126; 368/10, 276, 277, 280-282,
82-84, 239-242, 285

[57] CLAIM

The ornamental design for a wrist watch, as shown and described.

[56] References Cited

DESCRIPTION

U.S. PATENT DOCUMENTS

D. 263,452	3/1982	Wada	D10/38
D. 265,295	7/1982	Wada	D10/38
D. 267,548	1/1983	Wada	D10/38
D. 269,501	6/1983	Sato	D10/31
D. 287,403	12/1986	Kiiski	D10/31 X
D. 293,892	1/1988	Ichikawa	D10/38
4,504,062	3/1985	Smith	368/10 X

FIG. 1 is a front elevational view of a wrist watch showing my new design;
FIG. 2 is a top plan view thereof;
FIG. 3 is a right side elevational view thereof;
FIG. 4 is a left side elevational view thereof;
FIG. 5 is a bottom plan view thereof;
FIG. 6 is a rear elevational view thereof; and
FIG. 7 is a right front perspective view thereof.

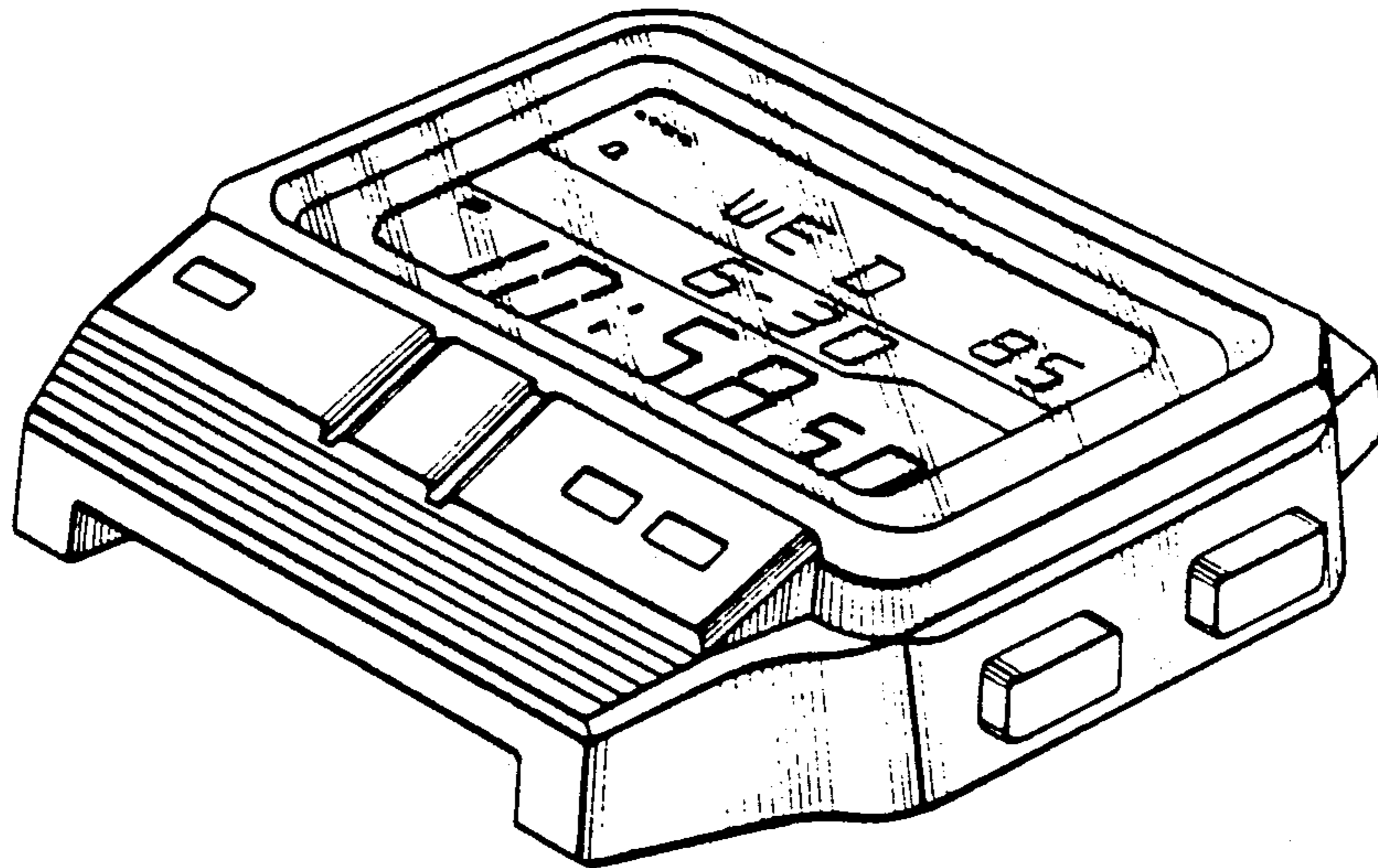

FIG. 2

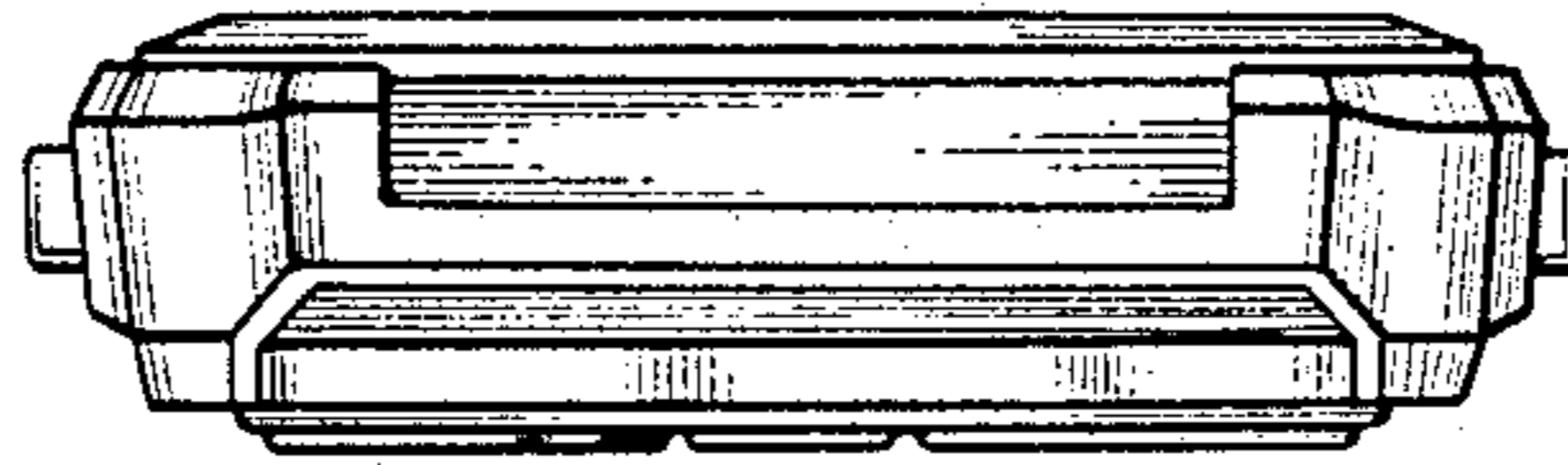

FIG. 4

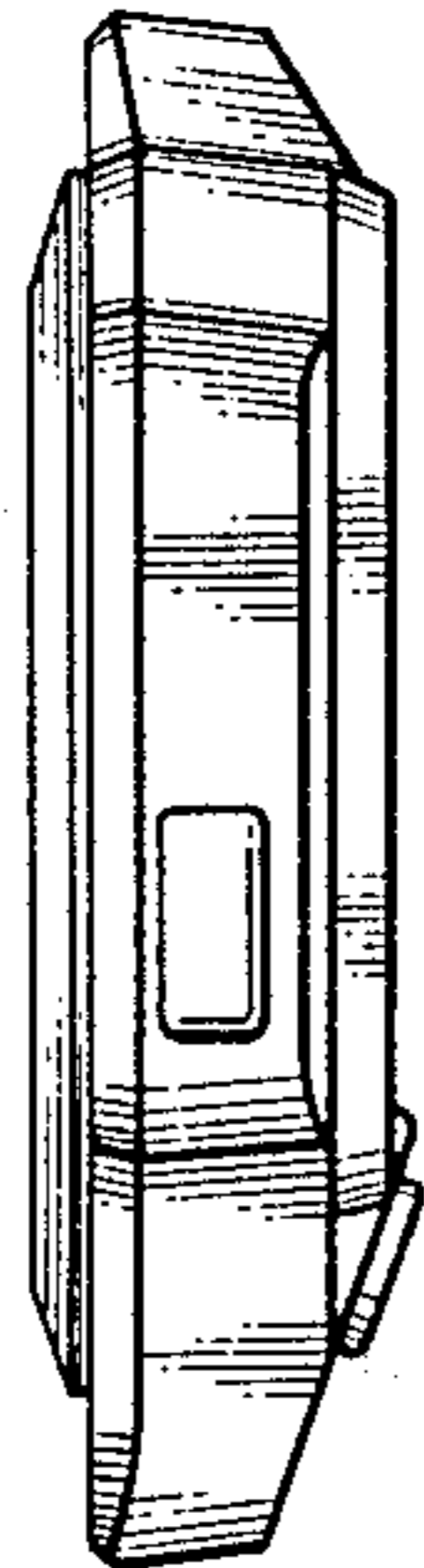

FIG. 1

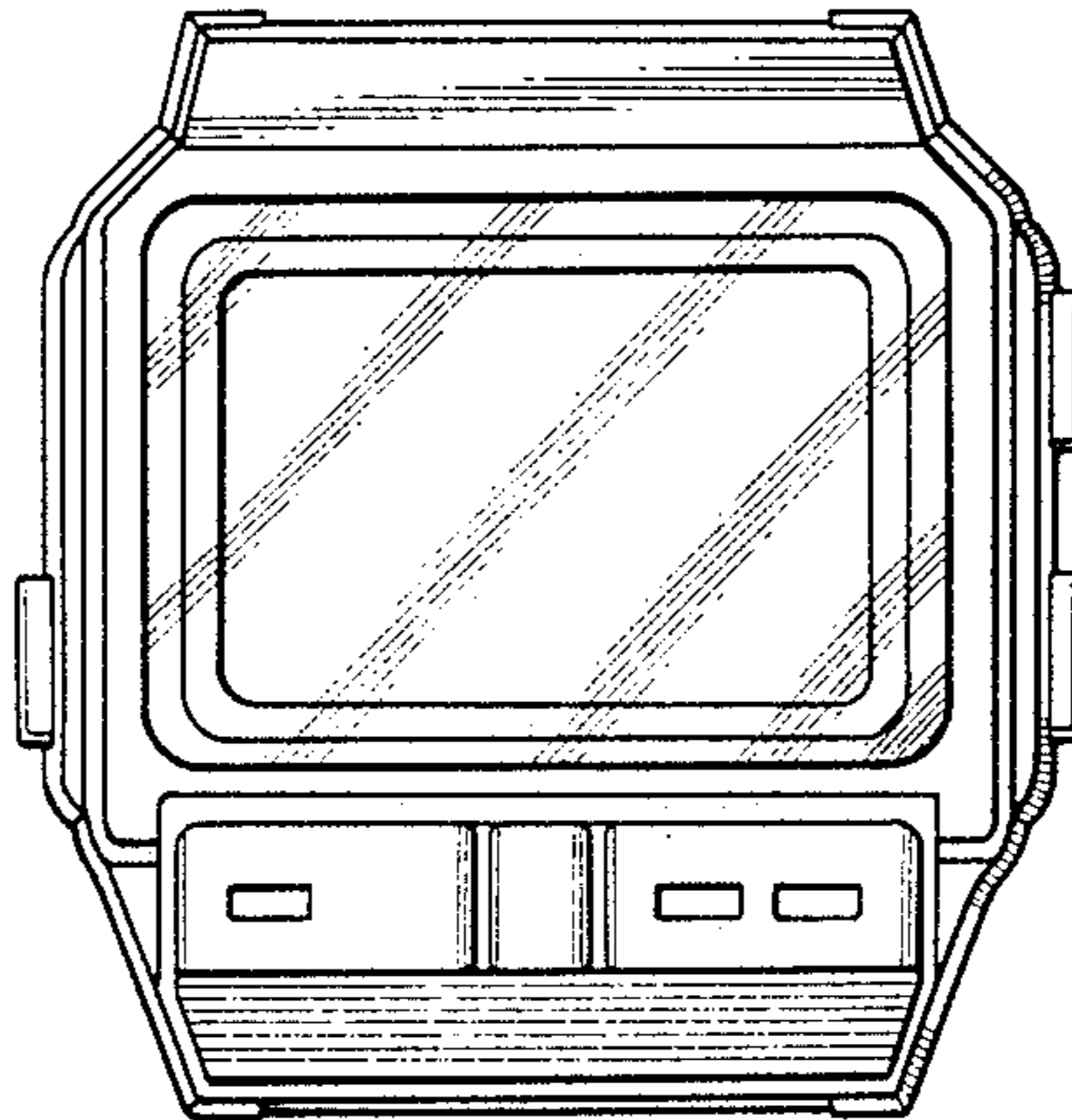

FIG. 3

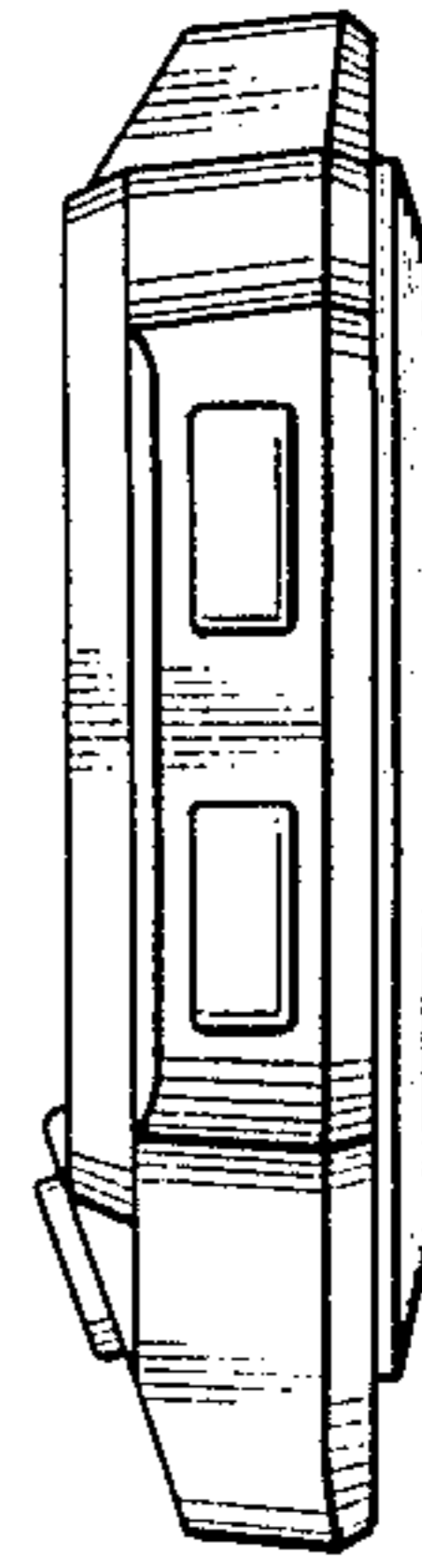

FIG. 5

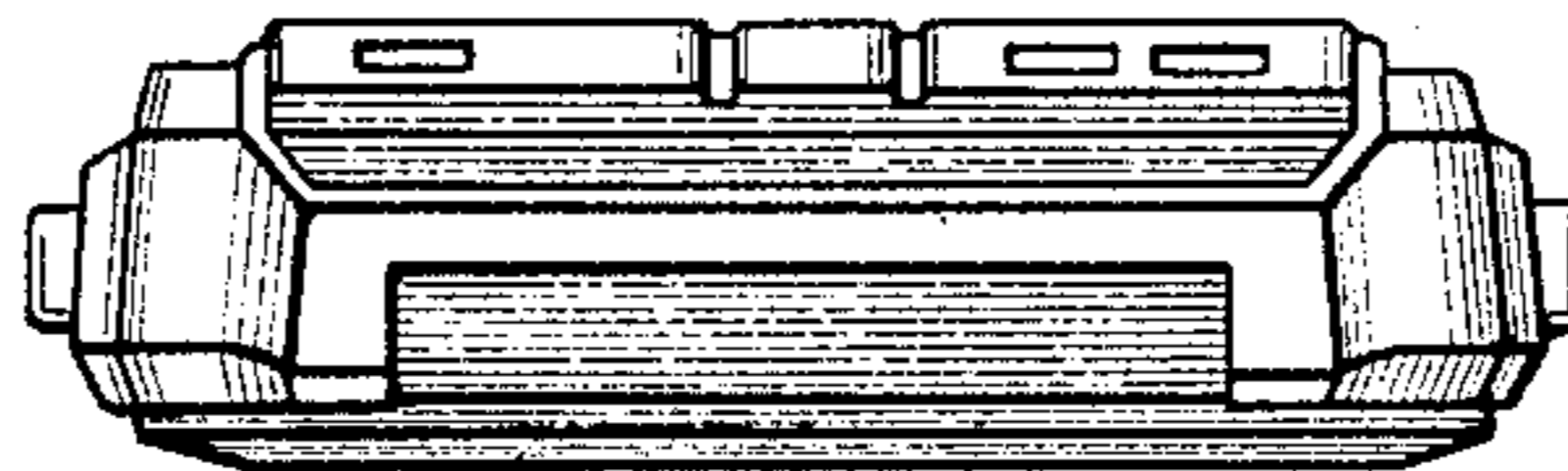

FIG. 6

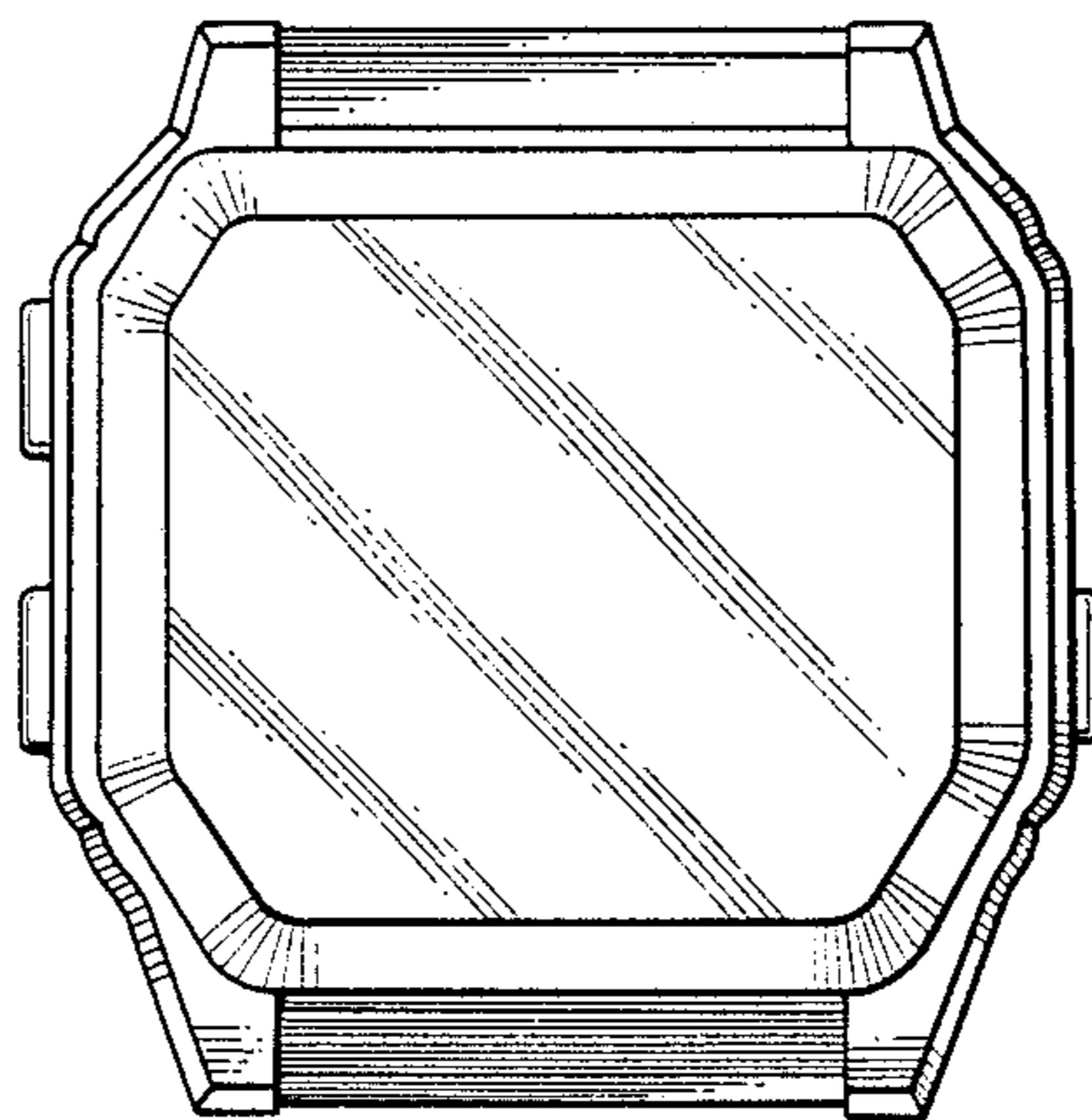

FIG. 7

